

# DSC

## DUELCO SAFETY CONTROLLER

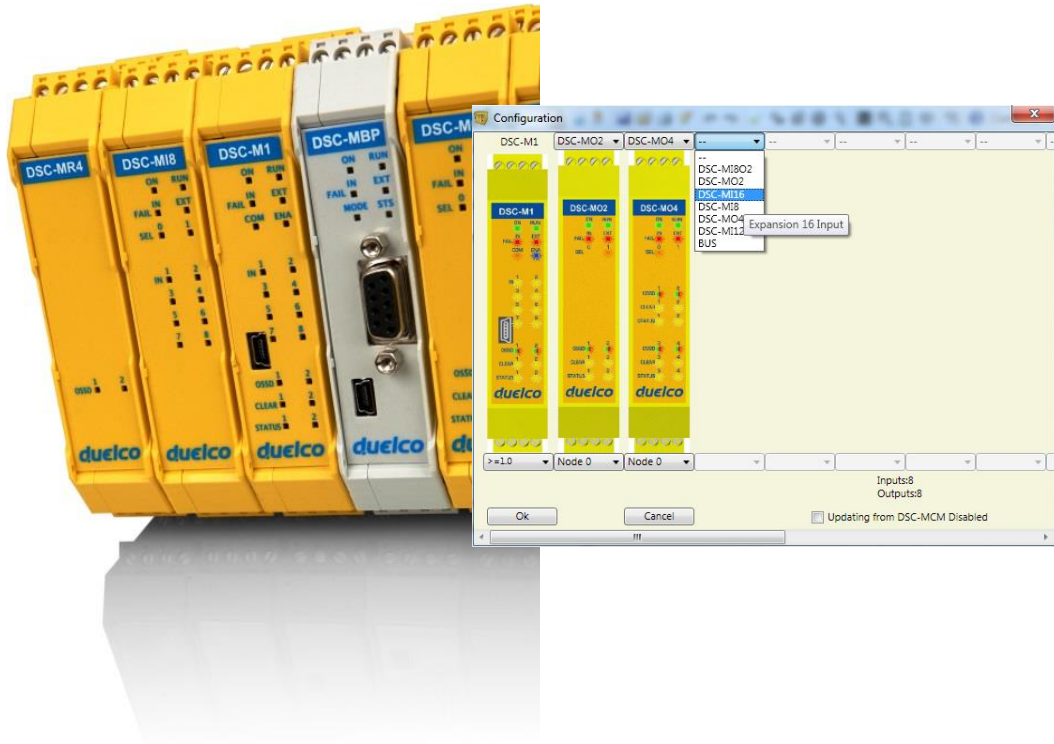

### Installation and use



*(Copy of the original instructions)*

Download free configuration software (click or scan)



# MODULAR SAFETY INTEGRATED CONTROLLER

## CONTENTS

<b>INTRODUCTION</b> .....	<b>7</b>
Contents of this handbook .....	7
Important safety instructions .....	7
Abbreviations and symbols .....	8
Applicable standards .....	8
<b>OVERVIEW</b> .....	<b>9</b>
<b>PRODUCT COMPOSITION</b> .....	<b>12</b>
<b>INSTALLATION</b> .....	<b>13</b>
Mechanical fastening .....	13
Calculation of safety distance of an ESPE connected to DSC .....	14
Electrical connections .....	14
Instructions concerning connection cables .....	15
Master Module M1 .....	15
Master Module M1S .....	16
USB input .....	17
DSC Configuration Memory (DSC-MCM) .....	17
MULTIPLE LOAD function .....	17
RESTORE function .....	18
Module MI8O2 .....	18
Module MI8O4 .....	19
Module MI8 .....	19
Module MI12T8 .....	20
Module MI16 .....	20
Module MO2 .....	21
Module MO4 .....	21
Module MO4L .....	22
Module MR2 .....	23
Module MR4 .....	23
Modules MV0 - MV1 - MV2 .....	24
ENCODER CONNECTIONS WITH RJ45 CONNECTOR (MV1, MV2) .....	25
Module MOR4 .....	26
Module MOR4S8 .....	26
Module MOS8 .....	27
Module MOS16 .....	27
Module MO4LHCS8 .....	28
Modulo MA4 .....	28
Analog sensor connections .....	29
Example of connection of DSC to the machine control system .....	30
CHECKLIST AFTER INSTALLATION .....	30
<b>OPERATING DIAGRAM</b> .....	<b>31</b>
<b>SIGNALS</b> .....	<b>32</b>
<b>INPUTS</b> .....	<b>32</b>
MASTER ENABLE .....	32
NODE SEL .....	32
PROXIMITY INPUT FOR SPEED CONTROLLER MV .....	33
Configuration With Interleaved Proximity (Figure 5) .....	33
RESTART_FBK .....	34
<b>OUTPUTS</b> .....	<b>35</b>

OUT STATUS .....	35
OUT TEST .....	35
OSSD (M1, MI8O2, MO2, MO4) .....	35
OSSD (M1S, MI8O4, MO4L) .....	35
OSSD (MO4LHCS8) .....	36
SAFETY RELAYS (MR2, MR4, MOR4, MOR4S8) .....	38
Characteristics of the output circuit .....	38
MR2/MR4 internal contacts diagram .....	38
Example of MR2 module connection with static OSSD outputs of a module M1 .....	39
Switching operation timing diagram .....	39
<b>TECHNICAL FEATURES .....</b>	<b>40</b>
GENERAL SYSTEM CHARACTERISTICS .....	40
Safety level parameters .....	40
General data .....	40
Enclosure .....	41
M1 module .....	41
M1S module .....	42
MI8O2 module .....	42
MI8O4 module .....	42
MI8 - MI16 modules .....	43
MI12T8 module .....	43
MO2 - MO4 modules .....	43
MO4L module .....	43
MOS8 - MOS16 modules .....	44
MR2 - MR4 modules .....	44
MOR4 - MOR4S8 module .....	44
MO4LHCS8 module .....	45
MV0 - MV1 - MV2 modules .....	45
MA4 module .....	46
MECHANICAL DIMENSIONS .....	47
SIGNALS .....	48
Master M1 (Figure 11) .....	48
Master M1S (Figure 11) .....	49
MI8O2 (Figure 13) .....	50
MI8O4 (Figure 13) .....	51
MI8 (Figure 15) .....	52
MI12T8 (Figure 17) .....	53
MI16 (Figure 17) .....	54
MO2 (Figure 18) .....	55
MO4 (Figure 19) .....	56
MO4L (Figure 13) .....	57
MOR4 (Figure 21) .....	58
MOR4S8 (Figure 22) .....	59
MOS8 (Figure 23) .....	60
MOS16 (Figure 24) .....	61
MV1, MV2 (Figure 25) .....	62
MR2 (Figure 26) / MR4 (Figure 27) .....	63
MO4LHCS8 (Figure 28) .....	64
MA4 (Figure 29) .....	65
TROUBLESHOOTING .....	66
Master M1 (Figure 30) .....	66
Master M1S (Figure 31) .....	67
MI8O2 (Figure 32) .....	68
MI8O4 (Figure 33) .....	69

MI8 (Figure 34) .....	70
MI12T8 (Figure 35) .....	71
MI16 (Figure 36) .....	72
MO2 / MO4 (Figure 37) .....	73
MO4L (Figure 38) .....	74
MOR4 (Figure 39) .....	75
MOR4S8 (Figure 40) .....	76
MOS8 (Figure 41) .....	77
MOS16 (Figure 42) .....	78
MV0, MV1, MV2 (Figure 43) .....	79
MO4LHCS8 (Figure 44) .....	80
MA4 (Figure 45) .....	81
<b>DSC SAFETY DESIGNER SOFTWARE .....</b>	<b>83</b>
Installing the software .....	83
PC HARDWARE requirements .....	83
PC SOFTWARE requirements .....	83
How to install MSD .....	83
Fundamentals .....	84
Standard tool bar .....	85
Textual tool bar .....	86
Create a new project (configure the DSC system) .....	86
EDIT CONFIGURATION (composition of the various modules) .....	87
Change user parameters .....	87
OBJECTS - OPERATOR - CONFIGURATION tool bars .....	88
Creating the diagram .....	90
Use of mouse right button .....	90
Example of a project .....	92
Project validation .....	92
Resources Allocation .....	93
Project report .....	94
Connect to DSC .....	96
Sending the configuration to the DSC .....	96
Download a configuration file (project) from DSC .....	96
Configuration LOG .....	96
System composition .....	97
Disconnecting System .....	97
MONITOR (I/O status in real time - textual) .....	98
MONITOR (I/O status in real time - textual - graphic) .....	98
Password protection .....	99
Level 1 password .....	99
Level 2 password .....	100
Password Change .....	100
TESTING the system .....	101
<b>OBJECT FUNCTION BLOCKS .....</b>	<b>102</b>
<b>OUTPUT OBJECTS .....</b>	<b>102</b>
OSSD (safety outputs) .....	102
SINGLE OSSD (safety output) .....	103
STATUS (signal output) .....	105
FIELD BUS PROBE .....	105
RELAY .....	106
Use with RESTART: Automatic (A) or Manual (B) (Category 2) .....	107
<b>INPUT OBJECTS .....</b>	<b>109</b>
E-STOP (emergency stop) .....	109
E-GATE (safety gate device) .....	110

SINGLE E-GATE (safety gate device) .....	111
LOCK FEEDBACK.....	112
ENABLE (enable key) .....	113
ESPE (optoelectronic safety light curtain / laser scanner) .....	114
FOOTSWITCH (safety pedal) .....	115
MOD-SEL (safety selector) .....	117
PHOTOCELL (safety photocell) .....	118
TWO-HAND (bimanual control) .....	119
NETWORK_IN.....	119
SENSOR.....	120
S-MAT (safety mat) .....	121
SWITCH.....	122
ENABLING GRIP SWITCH.....	123
TESTABLE SAFETY DEVICE.....	124
SOLID STATE DEVICE .....	125
FIELDBUS INPUT .....	126
LLO-LL1 .....	127
COMMENTS.....	127
TITLE .....	127
SPEED CONTROL TYPE FUNCTION BLOCKS.....	128
Warning concerning safety .....	128
SPEED CONTROL .....	129
WINDOW SPEED CONTROL .....	131
STAND STILL .....	133
STAND STILL AND SPEED CONTROL .....	135
ANALOG INPUT TYPE FUNCTION BLOCKS.....	138
ANALOG INPUT (4 inputs each MA4 module).....	138
OPERATOR FUNCTION BLOCKS.....	150
LOGICAL OPERATORS.....	150
AND.....	150
NAND .....	150
NOT.....	151
OR .....	151
NOR.....	151
XOR .....	152
XNOR.....	152
LOGICAL MACRO .....	153
MULTIPLEXER .....	153
DIGITAL COMPARATOR (M1S only).....	154
MEMORY OPERATORS.....	156
D FLIP FLOP (max number = 16 with M1, 32 with M1S).....	156
T FLIP FLOP (max number = 16 with M1, 32 with M1S).....	156
SR FLIP FLOP .....	156
USER RESTART MANUAL (max number = 16 with M1, 32 with M1S with other RESTART operators) .....	157
USER RESTART MONITORED (max number = 16 with M1, 32 with M1S with other RESTART operators) .....	158
MACRO RESTART MANUAL (max number = 16 with M1, 32 with M1S with other RESTART operators) .....	158
MACRO RESTART MONITORED (max number = 16 with M1, 32 with M1S with other RESTART operators) .....	159
PRE-RESET (M1S only) (max number = 32 with other RESTART operators) .....	160

GUARD LOCK OPERATORS (max number = 4 with M1, 8 with M1S) .....	161
GUARD LOCK .....	161
COUNTER OPERATORS .....	173
COUNTER (max number = 16) .....	173
COUNTER COMPARATOR .....	174
TIMER OPERATORS (max number = 32 with M1, 48 with M1S) .....	175
MONOSTABLE .....	175
MONOSTABLE_B .....	176
PASSING MAKE CONTACT .....	177
DELAY .....	177
LONG DELAY .....	178
DELAY COMPARATOR .....	179
DELAY LINE .....	180
LONG DELAY LINE .....	180
CLOCKING .....	181
MUTING FUNCTION .....	182
MUTING OPERATORS (max number = 4 with M1, 8 with M1S) .....	182
"Concurrent" MUTING .....	182
MUTING "L" .....	183
"Sequential" MUTING .....	184
MUTING "T" .....	185
MUTING OVERRIDE (max number = 4) .....	186
ANALOG OPERATORS (M1S only) .....	188
Analog Comparator .....	188
Adder (max number = 16) .....	188
Equality check (max number = 16) .....	189
MISCELLANEOUS FUNCTION BLOCKS .....	190
SERIAL OUTPUT (max number = 4 with M1, 8 with M1S) .....	190
NETWORK (max number = 1) .....	191
Example of application in Category 2 according to ISO 13849-1: .....	194
Logical block diagram of a safety function using the network .....	195
Example of application in Category 4 according to ISO 13849-1: .....	195
Logical block diagram of a safety function using the network .....	196
RESET M1 .....	196
OSSD EDM (M1S only, max number = 32) .....	196
INTERPAGE IN/OUT .....	197
TERMINATOR .....	197
SPECIAL APPLICATIONS .....	198
Output delay with manual .....	198
SIMULATOR FEATURE .....	199
Schematic Simulation .....	200
How to use graphic simulation .....	201
Application example of graphic simulation .....	205
DSC FAIL CODES .....	207
ERRORS LOG DOWNLOAD .....	208
<b>ACCESSORIES AND SPARE PARTS .....</b>	<b>209</b>
<b>WARRANTY .....</b>	<b>210</b>

## INTRODUCTION

### Contents of this handbook

This handbook describes how to use the DSC programmable safety module and its expansion units ("SLAVES");











it includes:

- a description of the system
- method of installation
- connections
- signals
- troubleshooting
- use of the configuration SW

### Important safety instructions

 This safety alert symbol indicates a potential **personal safety hazard**. Failure to comply with instructions bearing this symbol could pose a very serious risk to personnel.

 This symbol indicates an important instruction.

-  The DSC is built to the following safety levels: SIL 3, SILCL 3, PL e, Cat. 4, Type 4 in accordance with the applicable standards. However, the definitive SIL and PL of the application will depend on the number of safety components, their parameters and the connections that are made, as per the risk analysis.
-  Read the "Applicable Standards" section carefully.
-  Perform an in-depth risk analysis to determine the appropriate safety level for your specific application, on the basis of all the applicable standards.
-  Programming/configuration of the DSC is the sole responsibility of the installer or user.
-  The device must be programmed/configured in accordance with the application-specific risk analysis and all the applicable standards.
-  Once you have programmed/configured and installed the DSC and all the relative devices, run a complete application safety test (see "TESTING the system", page 101).
-  Always test the complete system whenever new safety components are added (see the "TESTING the system" section, page 101).
-  Duelco is not responsible for these operations or any risks in connection therewith.
-  Reference should be made to the handbooks and the relative product and/or application standards to ensure correct use of devices connected to the DSC within the specific application.
-  The ambient temperature in the place where the system is installed must be compatible with the operating temperature parameters stated on the product label and in the specifications.
-  For all matters concerning safety, if necessary, contact your country's competent safety authorities or the competent trade association.

## Abbreviations and symbols

DSC-MCM = DSC Configuration Memory: *memory chip for DSC M1/M1S (accessory)*  
DSC-MSC = DSC Safety Communication: *proprietary bus for expansion units*  
MSD = DSC Safety Designer: *DSC configuration SW running in Windows*  
LLO, LL1 = Logic Level 0, Logic Level 1  
OSSD = Output Signal Switching Device: *solid state safety output*  
MTTF<sub>d</sub> = Mean Time to Dangerous Failure  
PL = Performance Level  
PFH<sub>d</sub> = Probability of a dangerous failure per Hour  
SIL = Safety Integrity Level  
SILCL = Safety Integrity Level Claim Limit  
SW = Software

## Applicable standards

DSC complies with the following European Directives:

- 2006/42/EC "Machinery Directive"
- 2014/30/EU "Electromagnetic Compatibility Directive"
- 2014/35/EU "Low Voltage Directive"

and is built to the following standards:

CEI EN 61131-2	Programmable controllers, part 2: Equipment requirements and tests
EN ISO 13489-1	Safety of machinery: Safety related parts of control systems. General principles for design
EN 61496-1	Safety of machinery: Electro-sensitive protective equipment. Part 1: General requirements and tests.
EN 61508-1	Functional safety of electrical/electronic/programmable electronic safety-related systems: General requirements.
EN 61508-2	Functional safety of electrical/electronic/programmable electronic safety-related systems: Requirements for electrical/electronic/programmable electronic safety-related systems.
EN 61508-3	Functional safety of electrical/electronic/programmable electronic safety-related systems: Software requirements.
EN 61508-4	Functional safety of electrical/electronic programmable electronic safety related systems: Definitions and abbreviations.
IEC 61784-3	Digital data communication for measurement and control: Functional safety fieldbuses.
EN 62061	Safety of machinery. Functional safety of safety-related electrical, electronic and programmable electronic control systems
EN 81-20	Safety rules for the construction and installation of lifts. Lifts for the transport of persons and goods. Passenger and goods passenger lifts
EN 81-50	Safety rules for the construction and installation of lifts. Examinations and tests. Design rules, calculations, examinations and tests of lift components

Table 1



## OVERVIEW

DSC is a modular safety controller. It consists of a master unit (**M1** or **M1S**), which can be configured using the MSD graphic interface, and a number of expansion units connected to the main unit via the proprietary DSC-MSC bus.

The M1 or M1S can also be used as a stand-alone device and they are equipped with:

- **M1**: 8 safety inputs, 2 independent programmable dual channel safety outputs (OSSD) and 2 logic signal outputs
- **M1S**: 8 safety inputs, 4 independent programmable single channel safety outputs (OSSD) and 4 logic signal outputs

➔ The following expansions are available: I/O expansions (**M18O2** and **M18O4(with M1S only)**), input expansions (**M18**, **M112T8**, **M116**), output expansions (**MO2**, **MO4** and **MO4LHCS8**), signalling only expansions (**MOS8** and **MOS16**), guided contact safety relay output modules (**MR2**, **MR4**, **MOR4** and **MOR4S8**), encoder and proximity input expansions (**MV2**, **MV**, **MV0**) and diagnostic connections to the main fieldbuses: **MBP** (PROFIBUS), **MBC** (CanOpen), **MBD** (DeviceNet), **MBEI** (ETHERNET/IP), **MBEP** (Profinet), **MBEC** (ETHERCAT), **MBMR** (Modbus RTU), **MBEM** (Modbus/TCP) **MBCCL** (CC-link).

DSC is capable of monitoring the following safety sensors and commands:

optoelectronic sensors (safety light curtains, scanners, safety photocells), mechanical switches, safety mats, emergency stops, two-hand controls, all managed by a single flexible and expandable device.

The system must consist of just one Master M1 or M1S and a number of electronic expansions that can range from 0 to a maximum of 14, not more than 4 of which of the same type. There is no limit to the number of relay modules MR2 e MR4 that can be installed.

With 14 expansions, the system can have up to:

- **with M1**: 128 inputs, 16 safety outputs and 32 status outputs.
- **with M1S**: 128 inputs, 32 safety outputs and 48 status outputs.

MASTER and its SLAVE units communicate via the 5-way DSC-MSC bus (Duelco proprietary bus), physically arranged on the rear panel of each unit.

Furthermore, by means of MBx Fieldbus interfaces, are available:

- All inputs states (with diagnostics)
- All safety outputs states (with diagnostics)
- 8 fieldbus inputs with M1 or 32 fieldbus inputs with M1S (MBx firmware version  $\geq 2.0$ ). These fieldbus inputs can act in the schematic as physical inputs, but are not safety inputs and they can't be used in safety related applications.
- 16 probe outputs with M1 or 32 probe outputs with M1S (MBx firmware version  $\geq 2.0$ ). These probe outputs can be connected everywhere in the schematic by means of MSD software.

With the **MI8**, **MI16** and **MI12T8** DSC expansion units, the number of inputs in the system can be increased to allow more external devices to be connected. The **MI12T8** also provides 8 OUT\_TEST outputs.

The **MO2** and **MO4** DSC expansion units provide the system, respectively, with 2 and 4 OSSD (Output Signal Switching Device) pairs for controlling devices connected downstream of the **DSC**. These modules provides also 2 (**MO2**) or 4 (**MO4**) programmable logic signal outputs.

The **MO4LHCS8** is a safety module with 4 single channel High Current Safety Outputs (2A/channel usable also in pairs) and 4 relative inputs for external feedback contacts (EDM).

The module provides 8 programmable signal outputs.

The **MI802** provides 8 inputs, 2 pairs of OSSD outputs and 2 programmable signal outputs.

The **MI804** provides 8 inputs, 4 single channel OSSD outputs (usable also in pairs) and 4 programmable signal outputs or 4 relative inputs for external feedback contacts (EDM).

The **MO4L** provides 4 single channel OSSD outputs (usable also in pairs) and 4 programmable signal outputs or 4 relative inputs for external feedback contacts (EDM).

The **MR2** and **MR4** DSC expansion units provide the system with 2 and 4 N.O. guided contact safety relay outputs, respectively, with the related external relay feedback (N.C. contact).

The expansion units in the **MB** series permit connection to the most commonly used industrial fieldbus systems for diagnostics and data transmission like Profibus (**MBP**), Canopen (**MBC**), Devicenet (**MBD**), CClink (**MBCCL**), Profinet (**MBEP**), EthernetIP (**MBEI**), Ethercat (**MBEC**), Modbus RTU (**MBEM**).

**MBU** permits connection to devices with a USB port.

The **MCT1** and **MCT2** DSC units are used to connect the M1 to other slave units installed at a distance (< 50 m). Two MCT units installed at the required distance can be connected using a shielded cable (Duelco MC25, MC50 or other cable with the characteristics set out in the cable data sheet).

The **MV0**, **MV1** and **MV2** DSC expansion units can be used to control the following (up to PLe):

- Zero speed, Max. speed, Speed range;
- Direction of movement, rotation/translation;

Up to 4 speed thresholds can be set for each logic input (axis).

Each unit incorporates two logic inputs that can be configured using the MSD software and is thus capable of controlling up to two independent axes.

The **MOR4** and **MOR4S8** are safety units provided with 4 independent safety relay outputs and the corresponding 4 inputs for the external feedback contacts (EDM).

There are two possible output settings (configured using the MSD configuration software).

- Two pairs of connection contacts (2 N.O. contacts per output with 2 corresponding feedback inputs).
- Four independent single connection contacts (1 N.O. contact per output with 4 corresponding feedback inputs).

The MOR4S8 unit has 8 programmable signal outputs.

The **MOS8** and **MOS16** have 8 and 16 programmable signal outputs.

The **MA4** provides 4 independent safety analog inputs usable also in pairs.

The MSD software is capable of creating complex logics, using logical operators and safety functions such as muting, timer, counters, etc.

All this is performed through an easy and intuitive graphic interface.

The configuration performed on the PC is sent to the master unit via USB connection; the file resides in the M1 (or M1S) and can also be saved on the proprietary DSC-MCM memory chip (accessory). By DSC-MCM the configuration can therefore quickly be copied to another master unit.

➔ The DSC system is certified to the maximum safety level envisaged by the applicable industrial safety standards (SIL 3, SILCL 3, PL e, Cat. 4).

---

## PRODUCT COMPOSITION

---

The DSC M1 and M1S are supplied with:

- CD-ROM containing the free MSD SW, this PDF multi-language handbook and other product literature.
- Multi-language installation sheet.

➔ NB: the rear panel DSC-MSC connector and DSC-MCM memory can be ordered separately as accessories.

The expansion units are supplied with:

- Multilingual Installation sheet.
- Rear panel DSC-MSC connector (not present in the MR2 and MR4 which are connected via terminal blocks only).

➔ NB: to install an expansion unit (excluding relays) you will need the DSC-MSC connector supplied with the unit plus another DSC-MSC for the connection to the M1 or M1S.  
This can be ordered separately as an accessory.

## INSTALLATION

### Mechanical fastening

Fix the DSC system units to a 35mm DIN rail as follows:

1. Connect the same number of "DSC-MSC" 5-pole rear panel connectors as the number of units to be installed.
2. Fix the train of connectors thus obtained to the Omega DIN 35mm (EN 5022) rail (hooking them at the top first).
3. Fasten the units to the rail, arranging the contacts on the base of the unit on the respective connector. Press the unit gently until you feel it snap into place.
4. To remove a unit, use a screwdriver to pull down the locking latch on the back of the unit; then lift the unit upwards and pull.

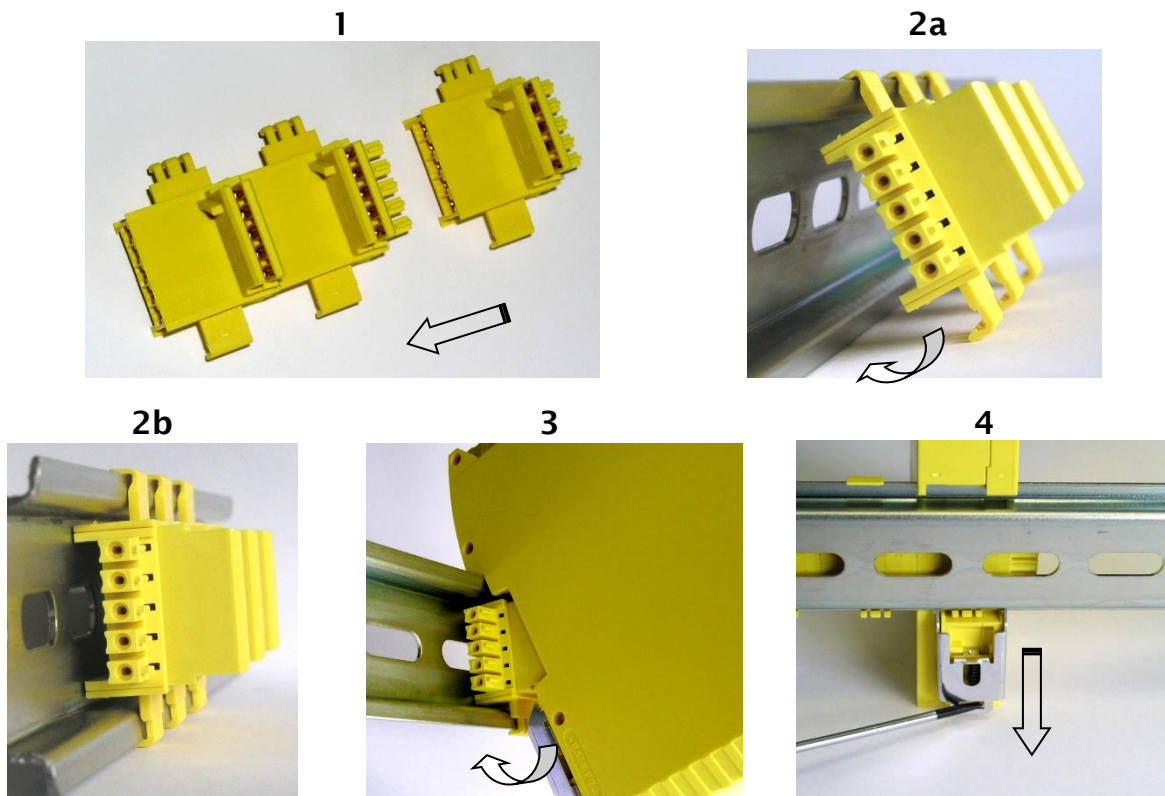

Figure 1

## Calculation of safety distance of an ESPE connected to DSC

Any Electro-sensitive Protective Equipment device connected to DSC, must be positioned at a distance equal to or greater than the minimum safety distance **S** so that the dangerous point can be reached only after stopping the dangerous movement of the machine.

- ☛ The european standard:  
- ISO 13855:2010- (EN 999:2008) Safety of machinery - *Positioning of safeguards with respect to the approach speeds of parts of the human body.*<sup>1</sup> provides the elements to calculate the proper safety distance.
- ☛ Carefully read the installation manual of each device for specific information on the correct positioning.
- ☛ Remember that the total response time depends on:  
DSC response time + ESPE response time + response time of the machine (i.e. the time taken by the machine to stop the dangerous movement from the moment in which the stop signal is transmitted).

## Electrical connections

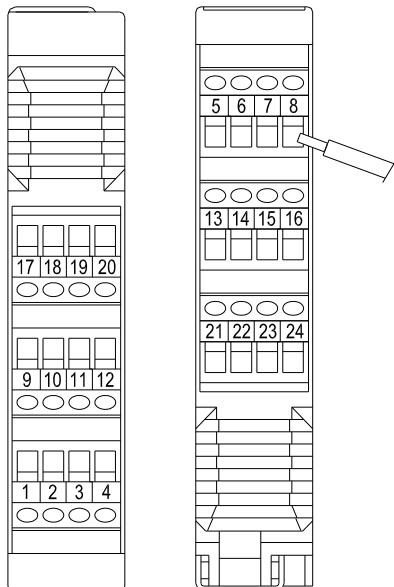

The DSC system units are provided with terminal blocks for the electrical connections. Each unit can have 8, 16 or 24 terminals. Each unit also has a rear panel plug-in connector (for communication with the master and with the other expansion units).

The MR2 and MR4 are connected via terminal blocks only.

➔ Terminal tightening torque: 5÷7lb-in (0,6÷0,7 Nm).

- ☛ Install safety units in an enclosure with a protection class of at least IP54.
- ☛ Connect the module when it is not powered.
- ☛ The supply voltage to the units must be 24Vdc  $\pm$ 20% (PELV, in compliance with the standard EN 60204-1 (Chapter 6.4)).
- ☛ Do not use the DSC to supply external devices.
- ☛ The same ground connection (0VDC) must be used for all system components.

<sup>1</sup> "Describe the methods that designers can use to calculate the minimum safety distance from a specific dangerous point for the safety devices, particularly Electro-sensitive devices (eg. light curtains), safety-mats or pressure sensitive floors and bimanual control. It contains a rule to determine the placement of safety devices based on approach speed and the stopping time of the machine, which can reasonably be extrapolated so that it also includes the interlocking guards without guard locking."

Instructions concerning connection cables.

- ➔ Wire size range: AWG 12÷30, (solid/stranded) (UL).
- ➔ Use 60/75°C copper (Cu) conductor only.
- ➔ We recommend the use of separate power supplies for the safety module and for other electrical power equipment (electric motors, inverters, frequency converters) or other sources of disturbance.
- ➔ Cables used for connections of longer than 50m must have a cross-section of at least 1 mm<sup>2</sup> (AWG16).

Connections of each single DSC system unit are listed in the table below:

Master Module M1

TERMINAL	SIGNAL	TYPE	DESCRIPTION	OPERATION
1	24VDC	-	24VDC power supply	-
2	MASTER_ENABLE1	Input	Master Enable 1	Input (" <b>type B</b> " according to EN 61131-2)
3	MASTER_ENABLE2	Input	Master Enable 2	Input (" <b>type B</b> " according to EN 61131-2)
4	0VDC	-	0VDC power supply	-
5	OSSD1_A	Output	Static output 1	PNP active high
6	OSSD1_B	Output		PNP active high
7	RESTART_FBK1	Input	Feedback/Restart 1	Input according to EN 61131-2
8	OUT_STATUS1	Output	Programmable signal output	PNP active high
9	OSSD2_A	Output	Static output 2	PNP active high
10	OSSD2_B	Output		PNP active high
11	RESTART_FBK2	Input	Feedback/Restart 2	Input according to EN 61131-2
12	OUT_STATUS2	Output	Programmable signal output	PNP active high
13	OUT_TEST1	Output	Short circuit detected output	PNP active high
14	OUT_TEST2	Output	Short circuit detected output	PNP active high
15	OUT_TEST3	Output	Short circuit detected output	PNP active high
16	OUT_TEST4	Output	Short circuit detected output	PNP active high
17	INPUT1	Input	Digital input 1	Input according to EN 61131-2
18	INPUT2	Input	Digital input 2	Input according to EN 61131-2
19	INPUT3	Input	Digital input 3	Input according to EN 61131-2
20	INPUT4	Input	Digital input 4	Input according to EN 61131-2
21	INPUT5	Input	Digital input 5	Input according to EN 61131-2
22	INPUT6	Input	Digital input 6	Input according to EN 61131-2
23	INPUT7	Input	Digital input 7	Input according to EN 61131-2
24	INPUT8	Input	Digital input 8	Input according to EN 61131-2

Table 2

Master Module M1S

TERMINAL	SIGNAL	TYPE	DESCRIPTION	OPERATION
1	24VDC	-	24VDC power supply	-
2	NC	-	-	-
3	NC	-	-	-
4	0VDC	-	0VDC power supply	-
5	OSSD1_A	Output	Solid State Safety Output 1	PNP active high
6	OSSD1_B	Output	Solid State Safety Output 2	PNP active high
7	RESTART_FBK1/ STATUS1	Input/ Output	Feedback/Restart 1	Input according to EN 61131-2
			Programmable signal output	Programmable signal output
8	RESTART_FBK2/ STATUS2	Input/ Output	Feedback/Restart 2	Input according to EN 61131-2
			Programmable signal output	Programmable signal output
9	OSSD2_A	Output	Solid State Safety Output 3	PNP active high
10	OSSD2_B	Output	Solid State Safety Output 4	PNP active high
11	RESTART_FBK3/ STATUS3	Input/ Output	Feedback/Restart 3	Input according to EN 61131-2
			Programmable signal output	Programmable signal output
12	RESTART_FBK4/ STATUS4	Input/ Output	Feedback/Restart 4	Input according to EN 61131-2
			Programmable signal output	Programmable signal output
13	OUT_TEST1	Output	Short circuit detected output	PNP active high
14	OUT_TEST2	Output	Short circuit detected output	PNP active high
15	OUT_TEST3	Output	Short circuit detected output	PNP active high
16	OUT_TEST4	Output	Short circuit detected output	PNP active high
17	INPUT1	Input	Digital input 1	Input according to EN 61131-2
18	INPUT2	Input	Digital input 2	Input according to EN 61131-2
19	INPUT3	Input	Digital input 3	Input according to EN 61131-2
20	INPUT4	Input	Digital input 4	Input according to EN 61131-2
21	INPUT5	Input	Digital input 5	Input according to EN 61131-2
22	INPUT6	Input	Digital input 6	Input according to EN 61131-2
23	INPUT7	Input	Digital input 7	Input according to EN 61131-2
24	INPUT8	Input	Digital input 8	Input according to EN 61131-2

Table 3

➔ The STATUS signal outputs are shared with the feedback/restart inputs of the OSSDs. To use them, the corresponding OSSD must be used with automatic reset without external feedback monitoring. For example, to use the STATUS1 output (Terminal 7), you must program OSSD1 (by means of the MSD software) with automatic reset without K feedback monitoring.



### USB input

The DSC master M1 and M1s include a mini USB 2.0 connector for connection to a Personal Computer where the **MSD** (DSC Safety Designer) configuration SW resides.

A USB cable of the correct size is available as an accessory (**CSU**).



Figure 2 - USB 2.0 front panel connector

### TECHNICAL DATA LABEL

Figure 3 - DSC-MCM LABEL

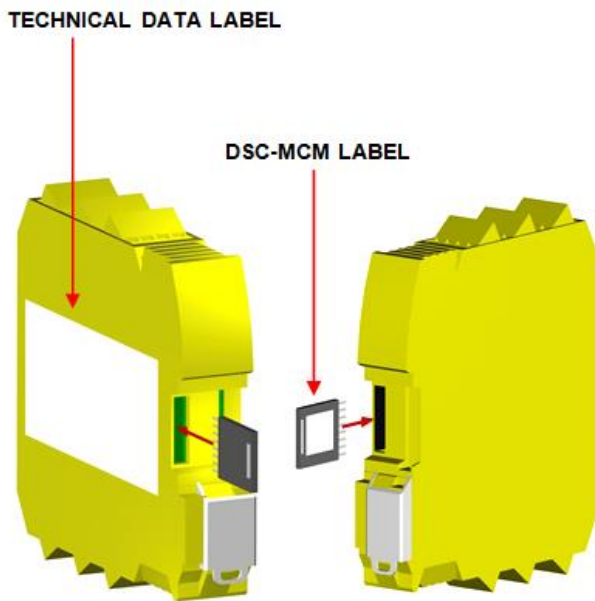

### DSC Configuration Memory (DSC-MCM)

A backup memory, called **DSC-MCM** (optional) can be installed in the DSC master M1/M1S and used to save the SW configuration parameters.

The DSC-MCM is written **each time** a new project is sent from the PC to the M1.

➔ Always switch the M1/M1S off before logging on to/logging off from the DSC-MCM.

Insert the card in the **slot in the rear panel of the M1 and M1S** (in the direction shown in Figure 3 - ).

### MULTIPLE LOAD function

To perform the configuration of several master modules without using a PC and the USB connector, you can save the desired configuration on a single DSC-MCM and then use it to download data on the masters modules to be configured simply inserting the DSC-MCM into the module and turning it on.

**⚠** If the file contained in the DSC-MCM is not identical to the one contained in M1/M1S, an overwrite operation that will permanently delete the configuration data contained in M1/M1S will be performed. In this case the module blinks fast leds COM and ENABLE.  
**WARNING: ALL DATA PREVIOUSLY CONTAINED IN M1/M1S WILL BE LOST.**

## RESTORE function

If the M1 or M1S unit is damaged, you can replace it with a new one; having already saved all the configurations on the DSC-MCM, all you need to do is insert the DSC-MCM in the new M1/M1S and switch on the DSC system, that will immediately load the backup configuration. In this way, the work interruptions will be minimized.

### Compatibility between DSC-MCM memory and Master modules:

- M1S can load configurations from DSC-MCM if it is written by a M1S or M1
- M1 can load configurations from DSC-MCM only if it is written by a M1

➔ The LOAD and RESTORE functions can be disabled via SW. (see Figure 50)

⚠ Each time DSC-MCM is used, carefully check that the chosen configuration is the one that was planned for that particular system. Try again a fully functional test of the system composed of DSC plus all devices connected to it (see the TESTING the system section).

## Module MI802

TERMINAL	SIGNAL	TYPE	DESCRIPTION	OPERATION
1	24VDC	-	24VDC power supply	-
2	NODE_SELO	Input	Node selection	Input (" <i>type B</i> " according to EN 61131-2 )
3	NODE_SEL1	Input		Input (" <i>type B</i> " according to EN 61131-2 )
4	0VDC	-	0VDC power supply	-
5	OSSD1_A	Output	Static output 1	PNP active high
6	OSSD1_B	Output		PNP active high
7	RESTART_FBK1	Input	Feedback/Restart 1	Input according to EN 61131-2
8	OUT_STATUS1	Output	Programmable signal output	PNP active high
9	OSSD2_A	Output	Static output 2	PNP active high
10	OSSD2_B	Output		PNP active high
11	RESTART_FBK2	Input	Feedback/Restart 2	Input according to EN 61131-2
12	OUT_STATUS2	Output	Programmable signal output	PNP active high
13	OUT_TEST1	Output	Short circuit detected output	PNP active high
14	OUT_TEST2	Output	Short circuit detected output	PNP active high
15	OUT_TEST3	Output	Short circuit detected output	PNP active high
16	OUT_TEST4	Output	Short circuit detected output	PNP active high
17	INPUT1	Input	Digital input 1	Input according to EN 61131-2
18	INPUT2	Input	Digital input 2	Input according to EN 61131-2
19	INPUT3	Input	Digital input 3	Input according to EN 61131-2
20	INPUT4	Input	Digital input 4	Input according to EN 61131-2
21	INPUT5	Input	Digital input 5	Input according to EN 61131-2
22	INPUT6	Input	Digital input 6	Input according to EN 61131-2
23	INPUT7	Input	Digital input 7	Input according to EN 61131-2
24	INPUT8	Input	Digital input 8	Input according to EN 61131-2

Table 4

Module MI804

TERMINAL	SIGNAL	TYPE	DESCRIPTION	OPERATION
1	24VDC	-	24VDC power supply	-
2	NODE_SEL0	-	Node selection	Input (" <b>type B</b> " according to EN 61131-2 )
3	NODE_SEL1	-		Input (" <b>type B</b> " according to EN 61131-2 )
4	0VDC	-	0VDC power supply	-
5	OSSD1_A	Output	Solid State Safety Output 1	PNP active high
6	OSSD1_B	Output	Solid State Safety Output 2	PNP active high
7	RESTART_FBK1/ STATUS1	Input/	Feedback/Restart 1	Input according to EN 61131-2
		Output	Programmable signal output	Programmable signal output
8	RESTART_FBK2/ STATUS2	Input/	Feedback/Restart 2	Input according to EN 61131-2
		Output	Programmable signal output	Programmable signal output
9	OSSD2_A	Output	Solid State Safety Output 3	PNP active high
10	OSSD2_B	Output	Solid State Safety Output 4	PNP active high
11	RESTART_FBK3/ STATUS3	Input/	Feedback/Restart 3	Input according to EN 61131-2
		Output	Programmable signal output	Programmable signal output
12	RESTART_FBK4/ STATUS4	Input/	Feedback/Restart 4	Input according to EN 61131-2
		Output	Programmable signal output	Programmable signal output
13	OUT_TEST1	Output	Short circuit detected output	PNP active high
14	OUT_TEST2	Output	Short circuit detected output	PNP active high
15	OUT_TEST3	Output	Short circuit detected output	PNP active high
16	OUT_TEST4	Output	Short circuit detected output	PNP active high
17	INPUT1	Input	Digital input 1	Input according to EN 61131-2
18	INPUT2	Input	Digital input 2	Input according to EN 61131-2
19	INPUT3	Input	Digital input 3	Input according to EN 61131-2
20	INPUT4	Input	Digital input 4	Input according to EN 61131-2
21	INPUT5	Input	Digital input 5	Input according to EN 61131-2
22	INPUT6	Input	Digital input 6	Input according to EN 61131-2
23	INPUT7	Input	Digital input 7	Input according to EN 61131-2
24	INPUT8	Input	Digital input 8	Input according to EN 61131-2

➔ The STATUS signal outputs are shared with the feedback/restart inputs of the OSSDs. To use them, the corresponding OSSD must be used with automatic reset without external feedback monitoring. For example, to use the STATUS1 output (Terminal 7), you must program OSSD1 with automatic reset without K feedback monitoring.

Module MI8

TERMINAL	SIGNAL	TYPE	DESCRIPTION	OPERATION
1	24VDC	-	24VDC power supply	-
2	NODE_SEL0	Input	Node selection	Input (" <b>type B</b> " according to EN 61131-2 )
3	NODE_SEL1	Input		Input (" <b>type B</b> " according to EN 61131-2 )
4	0VDC	-	0VDC power supply	-
5	INPUT1	Input	Digital input 1	Input according to EN 61131-2
6	INPUT2	Input	Digital input 2	Input according to EN 61131-2
7	INPUT3	Input	Digital input 3	Input according to EN 61131-2
8	INPUT4	Input	Digital input 4	Input according to EN 61131-2
9	OUT_TEST1	Output	Short circuit detected output	PNP active high
10	OUT_TEST2	Output	Short circuit detected output	PNP active high
11	OUT_TEST3	Output	Short circuit detected output	PNP active high
12	OUT_TEST4	Output	Short circuit detected output	PNP active high
13	INPUT5	Input	Digital input 5	Input according to EN 61131-2
14	INPUT6	Input	Digital input 6	Input according to EN 61131-2
15	INPUT7	Input	Digital input 7	Input according to EN 61131-2
16	INPUT8	Input	Digital input 8	Input according to EN 61131-2

Table 5

Module MI12T8

TERMINAL	SIGNAL	TYPE	DESCRIPTION	OPERATION
1	24VDC	-	24VDC power supply	-
2	NODE_SELO	Input	Node selection	Input (" <b>type B</b> " according to EN 61131-2)
3	NODE_SEL1	Input		Input (" <b>type B</b> " according to EN 61131-2)
4	0VDC	-	0VDC power supply	-
5	INPUT1	Input	Digital input 1	Input according to EN 61131-2
6	INPUT2	Input	Digital input 2	Input according to EN 61131-2
7	INPUT3	Input	Digital input 3	Input according to EN 61131-2
8	INPUT4	Input	Digital input 4	Input according to EN 61131-2
9	OUT_TEST1	Output	Short circuit detected output	PNP active high
10	OUT_TEST2	Output	Short circuit detected output	PNP active high
11	OUT_TEST3	Output	Short circuit detected output	PNP active high
12	OUT_TEST4	Output	Short circuit detected output	PNP active high
13	INPUT5	Input	Digital input 5	Input according to EN 61131-2
14	INPUT6	Input	Digital input 6	Input according to EN 61131-2
15	INPUT7	Input	Digital input 7	Input according to EN 61131-2
16	INPUT8	Input	Digital input 8	Input according to EN 61131-2
17	OUT_TEST5	Output	Short circuit detected output	PNP active high
18	OUT_TEST6	Output	Short circuit detected output	PNP active high
19	OUT_TEST7	Output	Short circuit detected output	PNP active high
20	OUT_TEST8	Output	Short circuit detected output	PNP active high
21	INPUT9	Input	Digital input 9	Input according to EN 61131-2
22	INPUT10	Input	Digital input 10	Input according to EN 61131-2
23	INPUT11	Input	Digital input 11	Input according to EN 61131-2
24	INPUT12	Input	Digital input 12	Input according to EN 61131-2

Table 6

Module MI16

TERMINAL	SIGNAL	TYPE	DESCRIPTION	OPERATION
1	24VDC	-	24VDC power supply	-
2	NODE_SELO	Input	Node selection	Input (" <b>type B</b> " according to EN 61131-2)
3	NODE_SEL1	Input		Input (" <b>type B</b> " according to EN 61131-2)
4	0VDC	-	0VDC power supply	-
5	INPUT1	Input	Digital input 1	Input according to EN 61131-2
6	INPUT2	Input	Digital input 2	Input according to EN 61131-2
7	INPUT3	Input	Digital input 3	Input according to EN 61131-2
8	INPUT4	Input	Digital input 4	Input according to EN 61131-2
9	OUT_TEST1	Output	Short circuit detected output	PNP active high
10	OUT_TEST2	Output	Short circuit detected output	PNP active high
11	OUT_TEST3	Output	Short circuit detected output	PNP active high
12	OUT_TEST4	Output	Short circuit detected output	PNP active high
13	INPUT5	Input	Digital input 5	Input according to EN 61131-2
14	INPUT6	Input	Digital input 6	Input according to EN 61131-2
15	INPUT7	Input	Digital input 7	Input according to EN 61131-2
16	INPUT8	Input	Digital input 8	Input according to EN 61131-2
17	INPUT9	Input	Digital input 9	Input according to EN 61131-2
18	INPUT10	Input	Digital input 10	Input according to EN 61131-2
19	INPUT11	Input	Digital input 11	Input according to EN 61131-2
20	INPUT12	Input	Digital input 12	Input according to EN 61131-2
21	INPUT13	Input	Digital input 13	Input according to EN 61131-2
22	INPUT14	Input	Digital input 14	Input according to EN 61131-2
23	INPUT15	Input	Digital input 15	Input according to EN 61131-2
24	INPUT16	Input	Digital input 16	Input according to EN 61131-2

Table 7

Module MO2

TERMINAL	SIGNAL	TYPE	DESCRIPTION	OPERATION
1	24VDC	-	24VDC power supply	-
2	NODE_SELO	Input	Node selection	Input (" <b>type B</b> " according to EN 61131-2 )
3	NODE_SEL1	Input		Input (" <b>type B</b> " according to EN 61131-2 )
4	0VDC	-	0VDC power supply	-
5	OSSD1_A	Output	Static output 1	PNP active high
6	OSSD1_B	Output		PNP active high
7	RESTART_FBK1	Input	Feedback/Restart 1	Input according to EN 61131-2
8	OUT_STATUS1	Output	Programmable signal output	PNP active high
9	OSSD2_A	Output	Static output 2	PNP active high
10	OSSD2_B	Output		PNP active high
11	RESTART_FBK2	Input	Feedback/Restart 2	Input according to EN 61131-2
12	OUT_STATUS2	Output	Programmable signal output	PNP active high
13	24VDC	-	24VDC power supply	24VDC output power supply *
14	n.c.	-	-	-
15	0VDC	-	0VDC power supply	0VDC output *
16	n.c.	-	-	-

Table 8

Module MO4

TERMINAL	SIGNAL	TYPE	DESCRIPTION	OPERATION
1	24VDC	-	24VDC power supply	-
2	NODE_SELO	Input	Node selection	Input (" <b>type B</b> " according to EN 61131-2 )
3	NODE_SEL1	Input		Input (" <b>type B</b> " according to EN 61131-2 )
4	0VDC	-	0VDC power supply	-
5	OSSD1_A	Output	Static output 1	PNP active high
6	OSSD1_B	Output		PNP active high
7	RESTART_FBK1	Input	Feedback/Restart 1	Input according to EN 61131-2
8	OUT_STATUS1	Output	Programmable signal output	PNP active high
9	OSSD2_A	Output	Static output 2	PNP active high
10	OSSD2_B	Output		PNP active high
11	RESTART_FBK2	Input	Feedback/Restart 2	Input according to EN 61131-2
12	OUT_STATUS2	Output	Programmable signal output	PNP active high
13	24VDC	-	24VDC power supply	24VDC outputs power supply *
14	24VDC	-	24VDC power supply	-
15	0VDC	-	0VDC power supply	0VDC outputs *
16	0VDC	-	0VDC power supply	-
17	OSSD4_A	Output	Static output 4	PNP active high
18	OSSD4_B	Output		PNP active high
19	RESTART_FBK4	Input	Feedback/Restart 4	Input according to EN 61131-2
20	OUT_STATUS4	Output	Programmable signal output	PNP active high
21	OSSD3_A	Output	Static output 3	PNP active high
22	OSSD3_B	Output		PNP active high
23	RESTART_FBK3	Input	Feedback/Restart 3	Input according to EN 61131-2
24	OUT_STATUS3	Output	Programmable signal output	PNP active high

Table 9

\* This terminal must be connected to the power supply for the unit to work properly.

Module MO4L

TERMINAL	SIGNAL	TYPE	DESCRIPTION	OPERATION
1	24VDC	-	24VDC power supply	-
2	NODE_SEL0	-	Node selection	Input (" <i>type B</i> " according to EN 61131-2 )
3	NODE_SEL1	-		Input (" <i>type B</i> " according to EN 61131-2 )
4	0VDC	-	0VDC power supply	-
5	OSSD1_A	Output	Solid State Safety Output 1	PNP active high
6	OSSD1_B	Output	Solid State Safety Output 2	PNP active high
7	RESTART_FBK1/ STATUS1	Input/ Output	Feedback/Restart 1	Input according to EN 61131-2
			Programmable signal output	Programmable signal output
8	RESTART_FBK2/ STATUS2	Input/ Output	Feedback/Restart 2	Input according to EN 61131-2
			Programmable signal output	Programmable signal output
9	OSSD2_A	Output	Solid State Safety Output 3	PNP active high
10	OSSD2_B	Output	Solid State Safety Output 4	PNP active high
11	RESTART_FBK3/ STATUS3	Input/ Output	Feedback/Restart 3	Input according to EN 61131-2
			Programmable signal output	Programmable signal output
12	RESTART_FBK4/ STATUS4	Input/ Output	Feedback/Restart 4	Input according to EN 61131-2
			Programmable signal output	Programmable signal output

➔ The STATUS signal outputs are shared with the feedback/restart inputs of the OSSDs. To use them, the corresponding OSSD must be used with automatic reset without external feedback monitoring.

Module MR2

TERMINAL	SIGNAL	TYPE	DESCRIPTION	OPERATION
1	24VDC	-	24VDC power supply	-
4	0VDC	-	0VDC power supply	-
5	OSSD1_A	Input	Control ZONE 1	PNP active high
6	OSSD1_B	Input		
7	FBK_K1_K2_1	Output	Feedback K1K2 ZONE 1	
9	A_NC1	Output	NC contact ZONE 1	
10	B_NC1	Output		
13	A_NO11	Output	NO1 contact ZONE 1	
14	B_NO11	Output		
15	A_NO12	Output	NO2 contact ZONE 1	
16	B_NO12	Output		

Table 10

Module MR4

TERMINAL	SIGNAL	TYPE	DESCRIPTION	OPERATION
1	24VDC	-	24VDC power supply	-
4	0VDC	-	0VDC power supply	-
5	OSSD1_A	Input	Control ZONE 1	PNP active high
6	OSSD1_B	Input		
7	FBK_K1_K2_1	Output	Feedback K1K2 ZONE 1	
9	A_NC1	Output	NC contact ZONE 1	
10	B_NC1	Output		
13	A_NO11	Output	NO1 contact ZONE 1	
14	B_NO11	Output		
15	A_NO12	Output	NO2 contact ZONE 1	
16	B_NO12	Output		
11	A_NC2	Output	NC contact ZONE 2	
12	B_NC2	Output		
17	OSSD2_A	Input	Control ZONE 2	PNP active high
18	OSSD2_B	Input		
19	FBK_K1_K2_2	Output	Feedback K1K2 ZONE 2	
21	A_NO21	Output	NO1 contact ZONE 2	
22	B_NO21	Output		
23	A_NO22	Output	NO2 contact ZONE 2	
24	B_NO22	Output		

Table 11

Modules MV0 - MV1 - MV2

TERMINAL	SIGNAL	TYPE	DESCRIPTION	OPERATION
1	24VDC	-	24VDC power supply	-
2	NODE_SEL0	Input	Node selection	Input (" <b>type B</b> " according to EN 61131-2)
3	NODE_SEL1	Input		Input (" <b>type B</b> " according to EN 61131-2)
4	0VDC	-	0VDC power supply	-
5	PROXI1_24V	Output	PROXIMITY 1 connections (ref. "PROXIMITY INPUT FOR SPEED CONTROLLER MV2" -> 33)	Power supply 24VDC to PROXI1
6	PROXI1_REF	Output		Power supply 0VDC to PROXI1
7	PROXI1 IN1 (3 WIRES)	Input		PROXI1 NO input
8	PROXI1 IN2 (4 WIRES)	Input		PROXI1 NC input
9	PROXI2_24V	Output	PROXIMITY 2 connections (ref. "PROXIMITY INPUT FOR SPEED CONTROLLER MV2" -> 33)	Power supply 24VDC to PROXI2
10	PROXI2_REF	Output		Power supply 0VDC to PROXI2
11	PROXI2 IN1 (3 WIRES)	Input		PROXI2 NO input
12	PROXI2 IN2 (4 WIRES)	Input		PROXI2 NC input
13	N.C.	-	Not connected	-
14	N.C.	-		-
15	N.C.	-		-
16	N.C.	-		-

Table 12



# ENCODER CONNECTIONS WITH RJ45 CONNECTOR (MV1, MV2)

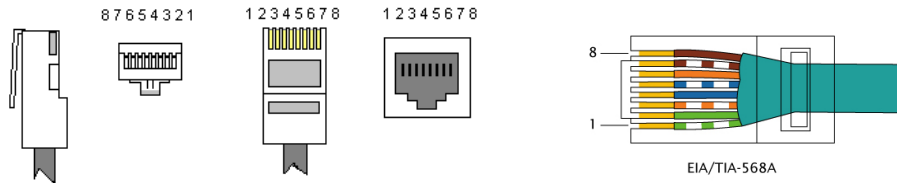

	PIN	MVT	MVTB	MVH	MVS
TWISTED *	1	5VDC	N.C.	N.C.	N.C.
	2	EXT_OV	EXT_OV	EXT_OV	EXT_OV
	3	N.C.	N.C.	N.C.	N.C.
TWISTED *	4	A	A	A	A
	5	$\bar{A}$	$\bar{A}$	$\bar{A}$	$\bar{A}$
TWISTED *	6	N.C.	N.C.	N.C.	N.C.
	7	B	B	B	B
	8	$\bar{B}$	$\bar{B}$	$\bar{B}$	$\bar{B}$

\* IN CASE OF UTILIZATION OF TWISTED CABLE

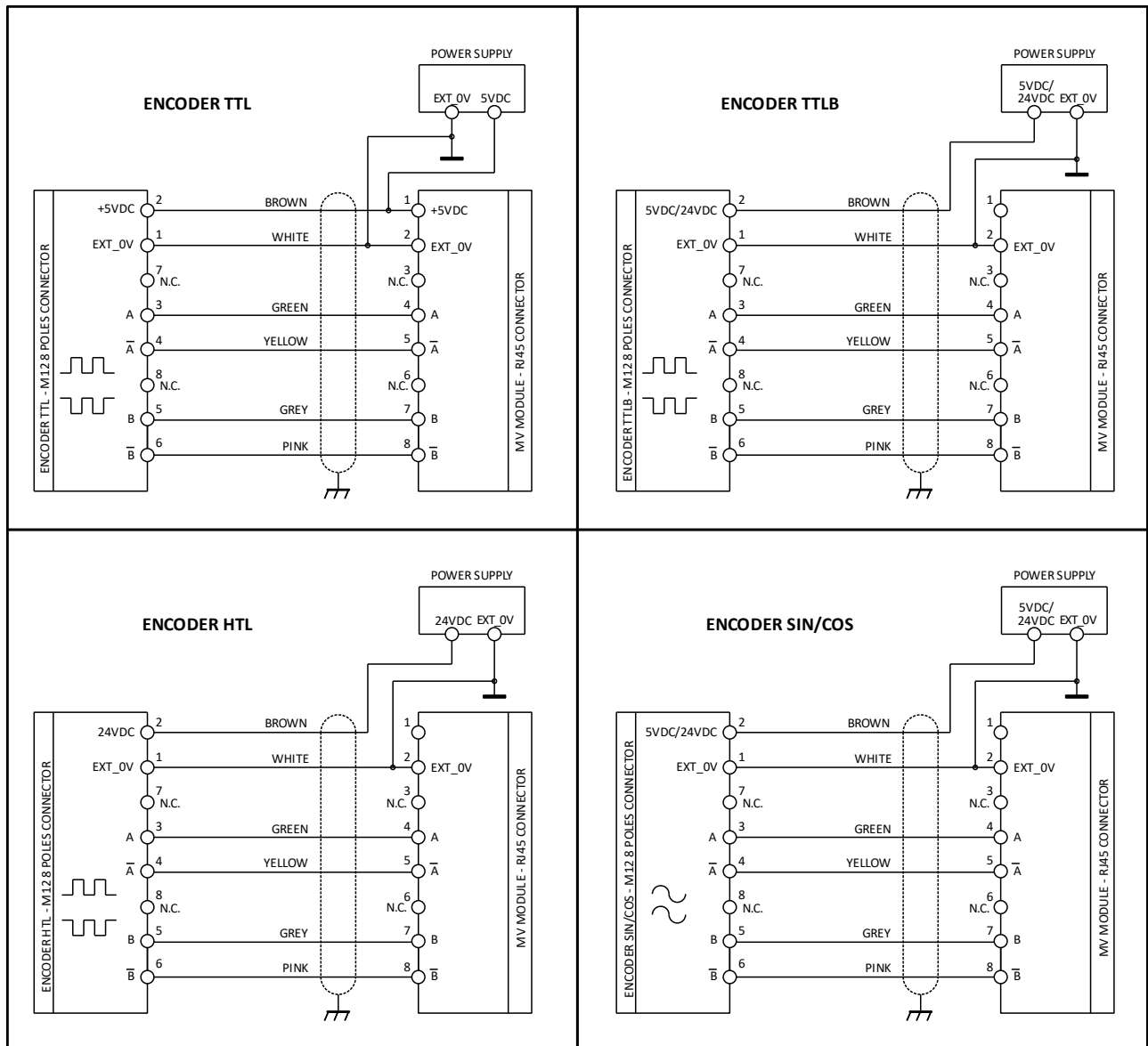

English

Module MOR4

TERMINAL	SIGNAL	TYPE	DESCRIPTION	OPERATION
1	24VDC	-	24VDC power supply	-
2	NODE_SELO	Input	Node selection	Input (" <b>type B</b> " according to EN 61131-2)
3	NODE_SEL1	Input		Input (" <b>type B</b> " according to EN 61131-2)
4	0VDC	-	0VDC power supply	-
5	REST_FBK1	Input	Feedback/Restart 1	Input (according EN 61131-2)
6	REST_FBK2	Input	Feedback/Restart 2	Input (according EN 61131-2)
7	REST_FBK3	Input	Feedback/Restart 3	Input (according EN 61131-2)
8	REST_FBK4	Input	Feedback/Restart 4	Input (according EN 61131-2)
9	A_NO1	Output	N.O. contact Channel 1	
10	B_NO1	Output		
11	A_NO2	Output	N.O. contact Channel 2	
12	B_NO2	Output		
13	A_NO3	Output	N.O. contact Channel 3	
14	B_NO3	Output		
15	A_NO4	Output	N.O. contact Channel 4	
16	B_NO4	Output		

Table 13

Module MOR4S8

TERMINAL	SIGNAL	TYPE	DESCRIPTION	OPERATION
1	24VDC	-	24VDC power supply	-
2	NODE_SELO	Input	Node selection	Input (" <b>type B</b> " according to EN 61131-2)
3	NODE_SEL1	Input		Input (" <b>type B</b> " according to EN 61131-2)
4	0VDC	-	0VDC power supply	-
5	REST_FBK1	Input	Feedback/Restart 1	Input (according EN 61131-2)
6	REST_FBK2	Input	Feedback/Restart 2	Input (according EN 61131-2)
7	REST_FBK3	Input	Feedback/Restart 3	Input (according EN 61131-2)
8	REST_FBK4	Input	Feedback/Restart 4	Input (according EN 61131-2)
9	A_NO1	Output	N.O. contact Channel 1	
10	B_NO1	Output		
11	A_NO2	Output	N.O. contact Channel 2	
12	B_NO2	Output		
13	A_NO3	Output	N.O. contact Channel 3	
14	B_NO3	Output		
15	A_NO4	Output	N.O. contact Channel 4	
16	B_NO4	Output		
17	OUT_STATUS1	Output	Programmable signal output 1	PNP active high
18	OUT_STATUS2	Output	Programmable signal output 2	PNP active high
19	OUT_STATUS3	Output	Programmable signal output 3	PNP active high
20	OUT_STATUS4	Output	Programmable signal output 4	PNP active high
21	OUT_STATUS5	Output	Programmable signal output 5	PNP active high
22	OUT_STATUS6	Output	Programmable signal output 6	PNP active high
23	OUT_STATUS7	Output	Programmable signal output 7	PNP active high
24	OUT_STATUS8	Output	Programmable signal output 8	PNP active high

Table 14

Module MOS8

PIN	SIGNAL	TYPE	DESCRIPTION	OPERATION
1	24VDC	-	24VDC power supply	-
2	NODE_SEL0	Input	Node selection	Input ("type B" according to EN 61131-2)
3	NODE_SEL1	Input		Input ("type B" according to EN 61131-2)
4	0VDC	-	0VDC power supply	-
5	24VDC STATUS 1-8	-	24VDC power supply OUTPUT STATUS 1-8	-
6	-	-	-	-
7	-	-	-	-
8	-	-	-	-
9	OUT_STATUS1	Output	Programmable signal output 1	PNP active high
10	OUT_STATUS2	Output	Programmable signal output 2	PNP active high
11	OUT_STATUS3	Output	Programmable signal output 3	PNP active high
12	OUT_STATUS4	Output	Programmable signal output 4	PNP active high
13	OUT_STATUS5	Output	Programmable signal output 5	PNP active high
14	OUT_STATUS6	Output	Programmable signal output 6	PNP active high
15	OUT_STATUS7	Output	Programmable signal output 7	PNP active high
16	OUT_STATUS8	Output	Programmable signal output 8	PNP active high

Table 15

Module MOS16

PIN	SIGNAL	TYPE	DESCRIPTION	OPERATION
1	24VDC	-	24VDC power supply	-
2	NODE_SEL0	Input	Node selection	Input ("type B" according to EN 61131-2 )
3	NODE_SEL1	Input		Input ("type B" according to EN 61131-2 )
4	0VDC	-	0VDC power supply	-
5	24VDC STATUS 1-8	-	24VDC power supply OUTPUT STATUS 1-8	-
6	24VDC STATUS 9-16	-	24VDC power supply OUTPUT STATUS 9-16	-
7	-	-	-	-
8	-	-	-	-
9	OUT_STATUS1	Output	Programmable signal output 1	PNP active high
10	OUT_STATUS2	Output	Programmable signal output 2	PNP active high
11	OUT_STATUS3	Output	Programmable signal output 3	PNP active high
12	OUT_STATUS4	Output	Programmable signal output 4	PNP active high
13	OUT_STATUS5	Output	Programmable signal output 5	PNP active high
14	OUT_STATUS6	Output	Programmable signal output 6	PNP active high
15	OUT_STATUS7	Output	Programmable signal output 7	PNP active high
16	OUT_STATUS8	Output	Programmable signal output 8	PNP active high
17	OUT_STATUS9	Output	Programmable signal output 9	PNP active high
18	OUT_STATUS10	Output	Programmable signal output 10	PNP active high
19	OUT_STATUS11	Output	Programmable signal output 11	PNP active high
20	OUT_STATUS12	Output	Programmable signal output 12	PNP active high
21	OUT_STATUS13	Output	Programmable signal output 13	PNP active high
22	OUT_STATUS14	Output	Programmable signal output 14	PNP active high
23	OUT_STATUS15	Output	Programmable signal output 15	PNP active high
24	OUT_STATUS16	Output	Programmable signal output 16	PNP active high

Table 16

Module MO4LHCS8

PIN	SIGNAL	TYPE	DESCRIPTION	OPERATION
1	24VDC	-	24VDC power supply	-
2	NODE_SEL0	Input	Node selection	Input ("type B" according to EN 61131-2)
3	NODE_SEL1	Input		Input ("type B" according to EN 61131-2)
4	0VDC	-	0VDC power supply	-
5	REST_FBK1	Input	Feedback/Restart 1	Input (according EN 61131-2)
6	REST_FBK2	Input	Feedback/Restart 2	Input (according EN 61131-2)
7	REST_FBK3	Input	Feedback/Restart 3	Input (according EN 61131-2)
8	REST_FBK4	Input	Feedback/Restart 4	Input (according EN 61131-2)
9	OSSD1	Output	Safety Output 1	PNP active high 4 single channels (or 2 dual channels)
10	OSSD2	Output	Safety Output 2	
11	OSSD3	Output	Safety Output 3	
12	OSSD4	Output	Safety Output 4	
13	-	-	-	-
14	24 VDC	-	24VDC power supply	-
15	-	-	-	-
16	-	-	-	-
17	OUT_STATUS1	Output	Programmable signal output 1	PNP active high
18	OUT_STATUS2	Output	Programmable signal output 2	PNP active high
19	OUT_STATUS3	Output	Programmable signal output 3	PNP active high
20	OUT_STATUS4	Output	Programmable signal output 4	PNP active high
21	OUT_STATUS5	Output	Programmable signal output 5	PNP active high
22	OUT_STATUS6	Output	Programmable signal output 6	PNP active high
23	OUT_STATUS7	Output	Programmable signal output 7	PNP active high
24	OUT_STATUS8	Output	Programmable signal output 8	PNP active high

Table 17

Modulo MA4

PIN	SIGNAL	TYPE	DESCRIPTION	OPERATION
1	24 VDC	-	24VDC power supply	-
2	NODE_SEL0	Input	Node selection	Input ("type B" according to EN 61131-2)
3	NODE_SEL1	Input		Input ("type B" according to EN 61131-2)
4	0 VDC	-	0VDC power supply	-
9	24VDC_S1	Output	Sensor 1 Connections	Isolated 24VDC power supply for sensor 1
10	IN_S1	Input		4/20mA sensor 1 Input
	NEG_S1	Input		0/10V sensor 1 negative input
11	OUT_S1	Output		4/20mA sensor 1 Output
	POS_S1	Input	0/10V sensor 1 positive input	
12	0 VDC_S1	Output	Isolated 0VDC reference for sensor 1	
13	24VDC_S3	Output	Sensor 3 Connections	Isolated 24VDC power supply for sensor 3
14	IN_S3	Input		4/20mA sensor 3 Input
	NEG_S3	Input		0/10V sensor 3 negative input
15	OUT_S3	Output		4/20mA sensor 3 Output
	POS_S3	Input	0/10V sensor 3 positive input	
16	0 VDC_S3	Output	Isolated 0VDC reference for sensor 3	
17	24VDC_S2	Output	Sensor 2 Connections	Isolated 24VDC power supply for sensor 2
18	IN_S2	Input		4/20mA sensor 2 Input
	NEG_S2	Input		0/10V sensor 2 negative input
19	OUT_S2	Output		4/20mA sensor 2 Output
	POS_S2	Input	0/10V sensor 2 positive input	
20	0 VDC_S2	Output	Isolated 0VDC reference for sensor 2	
21	24VDC_S4	Output	Sensor 4 Connections	Isolated 24VDC power supply for sensor 4
22	IN_S4	Input		4/20mA sensor 4 Input
	NEG_S4	Input		0/10V sensor 4 negative input
23	OUT_S4	Output		4/20mA sensor 4 Output
	POS_S4	Input	0/10V sensor 4 positive input	
24	0 VDC_S4	Output	Isolated 0VDC reference for sensor 4	

Table 18

## Analog sensor connections

The MA4 module is suitable for:

- 4/20mA current output sensors with 2/3/4 wires
- 0/20mA current output sensors with 2/3/4 wires
- 0/10V voltage output sensors with 3 wires

Following are shown some connections example:

### 2 WIRES CURRENT SENSOR

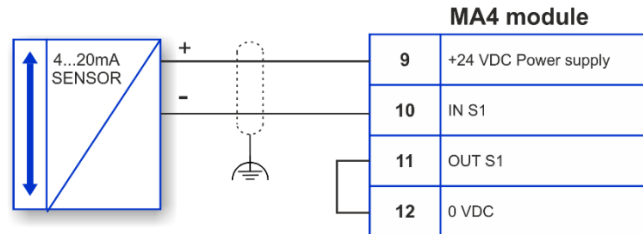

### 3 WIRES CURRENT SENSOR

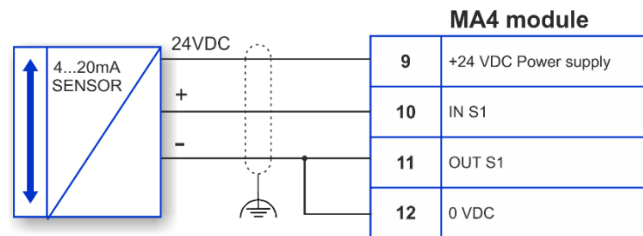

### 4 WIRES CURRENT SENSOR

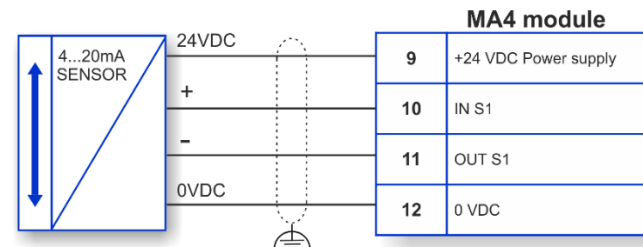

### 3 WIRES VOLTAGE SENSOR

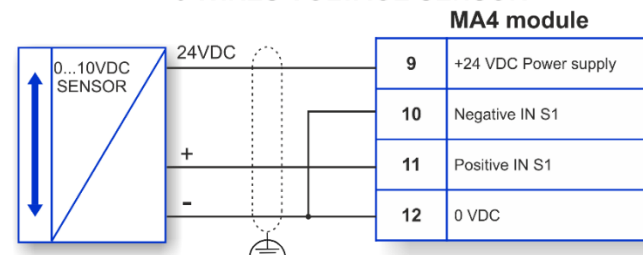

- ⚠ If shielded cables are not used or if the shield connection to PE is not properly wired then electromagnetic disturbance could cause signal corruption. A corrupted signal could lead to unexpected behavior of the module which as a consequence could lead to potentially severe damage to people or things.
- ⚠ If the sensor connections are not correct or if the type of sensor connected to the input is incorrect (for example a voltage sensor connected to a current input and vice versa), the functionality of the module is not more guaranteed.
- ⚠ Perform a complete system TEST (see "TESTING the system").

## Example of connection of DSC to the machine control system

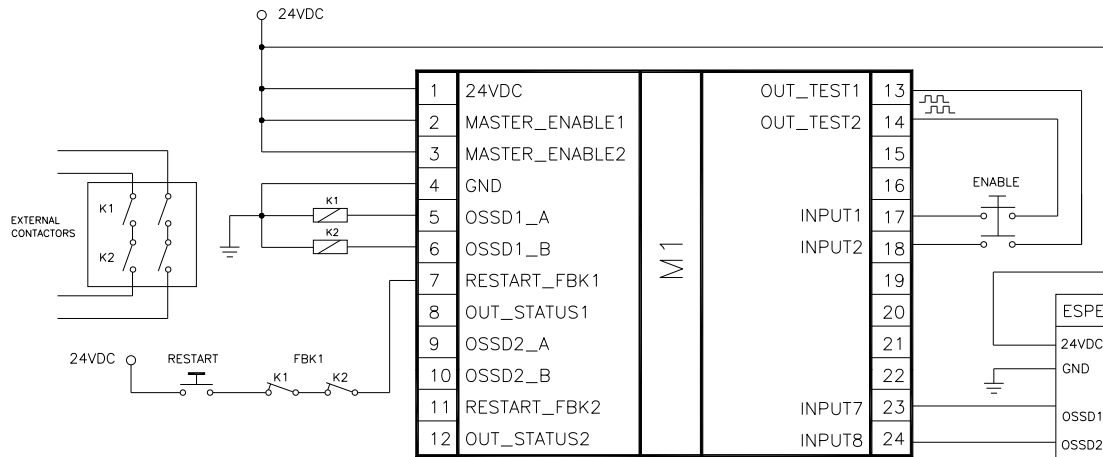

Figure 4

## CHECKLIST AFTER INSTALLATION

The DSC system is able to detect the faults that occurs in each own module. Anyway to have the system perfect operation perform the following checks at start up and at least every one year:

1. Operate a complete system TEST (see "TESTING the system")
2. Verify that all the cables are correctly inserted and the terminal blocks well screwed.
3. Verify that all the leds (indicators) light on correctly.
4. Verify the positioning of all the sensors connected to DSC.
5. Verify the correct fixing of DSC to the Omega rail.
6. Verify that all the external indicators (lamps) work properly.

➔ After installation, maintenance and after any eventual configuration change perform a System TEST as described in the paragraph "TESTING the system" at page 101.

# OPERATING DIAGRAM

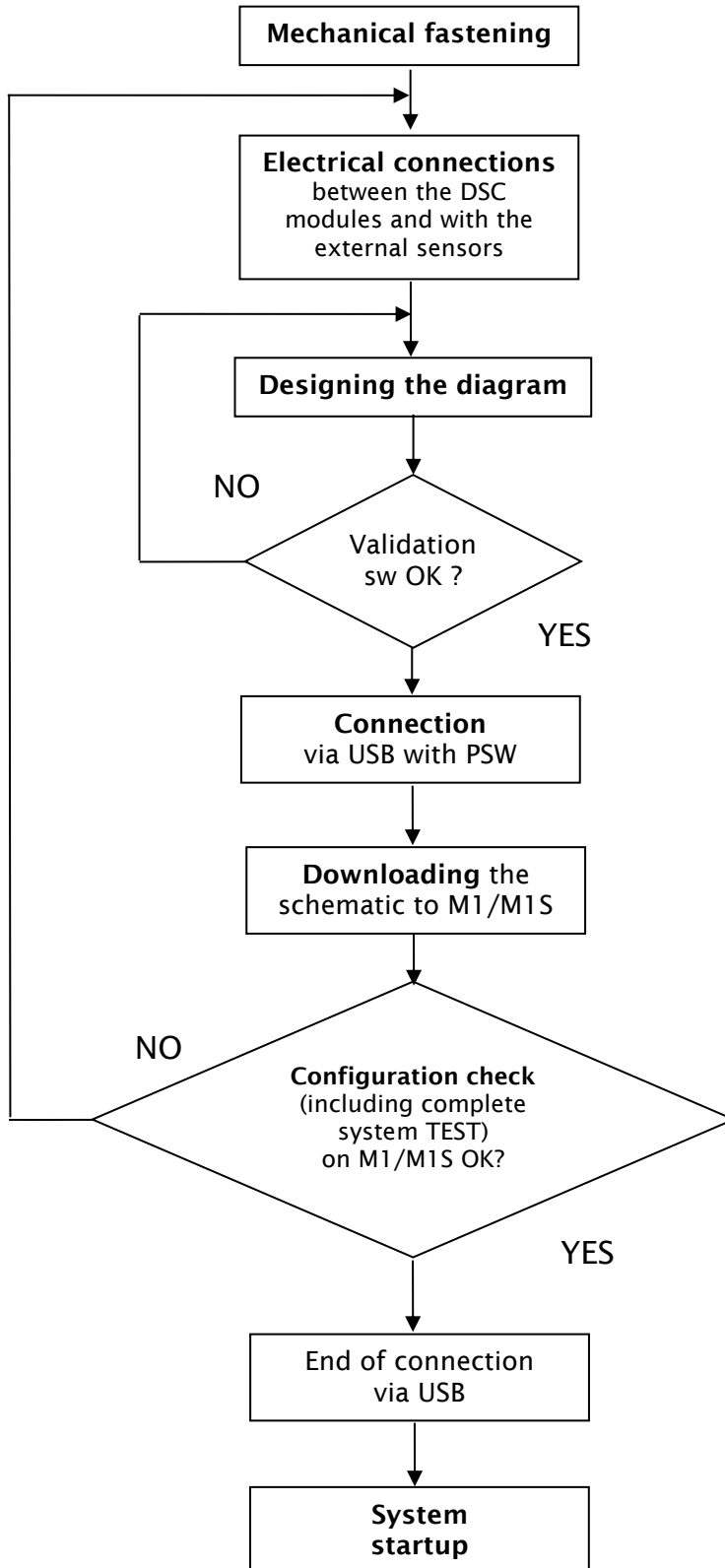

## SIGNALS

### INPUTS

#### MASTER ENABLE

The DSC M1 master has two inputs: MASTER\_ENABLE1 and MASTER\_ENABLE2.

- ➔ These signals must both be permanently set to logic level 1 (24VDC) for the DSC to operate. If the user needs to disable the DSC simply lower these inputs to logic level 0 (0VDC).
- ➔ These input are not present on M1S which is always enabled.

#### NODE SEL

The NODE\_SEL0 and NODE\_SEL1 inputs (on the SLAVE units) are used to attribute a physical address to the slave units with the connections shown in Table 19:

	NODE_SEL1 (Terminal 3)	NODE_SEL0 (Terminal 2)
NODE 0	0 (or not connected)	0 (or not connected)
NODE 1	0 (or not connected)	24VDC
NODE 2	24VDC	0 (or not connected)
NODE 3	24VDC	24VDC

Table 19

- ➔ It is not allowed to use the same physical address on two units of the same type.
- ➔ In order to be used, the expansion units must be addressed at the time of installation (see the NODE SEL section).



---

## PROXIMITY INPUT FOR SPEED CONTROLLER MV

---

### Configuration With Interleaved Proximity (Figure 5)

---

When an axis of the MV modules is configured for a measurement with two proximity switches, these can be configured in interleaved mode. Under the conditions listed below the system reaches a Performance Level = PLe:

- Proximity switches must be fitted such that the recorded signals overlap.
- Proximity switches must be fitted such that at least one is always activated.

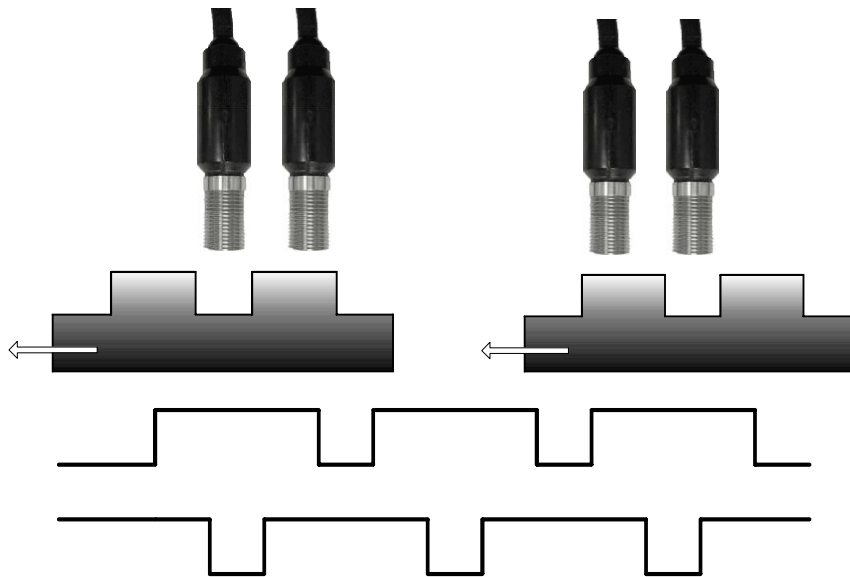

Figure 5

In addition:

- The proximity switches must be PNP type.
- The proximity switches must be NO type (Output ON when detecting metal).
- With the above conditions fulfilled, the DC value is equal to 90%.
- The two proximity switches must be of the same model, with MTTF > 70 years.

RESTART\_FBK

The RESTART\_FBK signal input allows the DSC to verify an EDM (External Device Monitoring) feedback signal (series of contacts) from the external contactors, and to monitor Manual/Automatic operation (See the list of possible connections in Table 20).

- ⚠ If the application requires it, the response time of the external contactors must be verified by an additional device.
- ⚠ The RESTART command must be installed outside the danger area in a position where the danger area and the entire work area concerned are clearly visible.
- ⚠ It must not be possible to reach the control from inside the danger area.

MODE OF OPERATION	EDM	RESTART_FBK
AUTOMATIC	With K1_K2 control	
	Without K1_K2 control	
MANUAL	With K1_K2 control	
	Without K1_K2 control	

Table 20

## OUTPUTS

### OUT STATUS

The OUT STATUS signal is a Programmable signal output that can indicate the status of:

- An input.
- An output.
- A node of the logic diagram designed using the MSD.

### OUT TEST

The OUT TEST signals must be used to monitor the presence of short-circuits or overloads on the inputs (Figure 6).

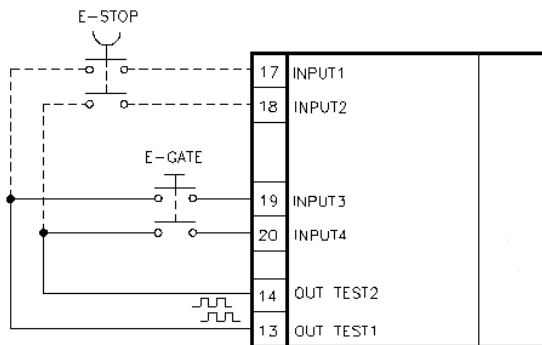

- ➔ The maximum number of controllable inputs for each output OUT TEST is 4 INPUTs (parallel connection)
- ➔ The maximum allowed length for OUT TEST signal connections is = 100m.

Figure 6

### OSSD (M1, MI8O2, MO2, MO4)

The M1, MI8O2, MO2, MO4 modules are equipped with OSSD (*static semiconductor safety outputs*) dual channel. These outputs are short circuit protected, cross circuit monitored and supply:

- In the ON condition:  $U_v - 0,75V \div U_v$  (where  $U_v$  is  $24V \pm 20\%$ )
- In the OFF condition:  $0V \div 2V$  r.m.s.

The maximum load of  $400mA@24V$  corresponds to a minimum resistive load of  $60\Omega$ . The maximum capacitive load is  $0.82\mu F$ . The maximum inductive load is 2 mH.

### OSSD (M1S, MI8O4, MO4L)

The M1S, MI8O4, MO4L modules are equipped with OSSD (*static semiconductor safety outputs*) single channel. These outputs are short circuit protected, cross circuit monitored and supply:

- In the ON condition:  $U_v - 0,75V \div U_v$  (where  $U_v$  is  $24V \pm 20\%$ )
- In the OFF condition:  $0V \div 2V$  r.m.s.

The maximum load of  $400mA@24V$  corresponds to a minimum resistive load of  $60\Omega$ . The maximum capacitive load is  $0.82\mu F$ . The maximum inductive load is 2 mH.

Different output configurations (configurable with MSD configuration software) can be set:

- 4 single channels (1 Safety Output per channel with its relative feedback input).
- 2 dual channels (2 Safety Outputs per channel with their relative feedback input).
- 1 dual channel and 2 single channels.



Using single channels OSSD, to maintain Safety Integrity Level (SIL) "3" requirements the OSSD outputs must be independent.

**Common cause failures between OSSD outputs must be excluded by observing an appropriate cable installation (i.e. separate cable paths).**

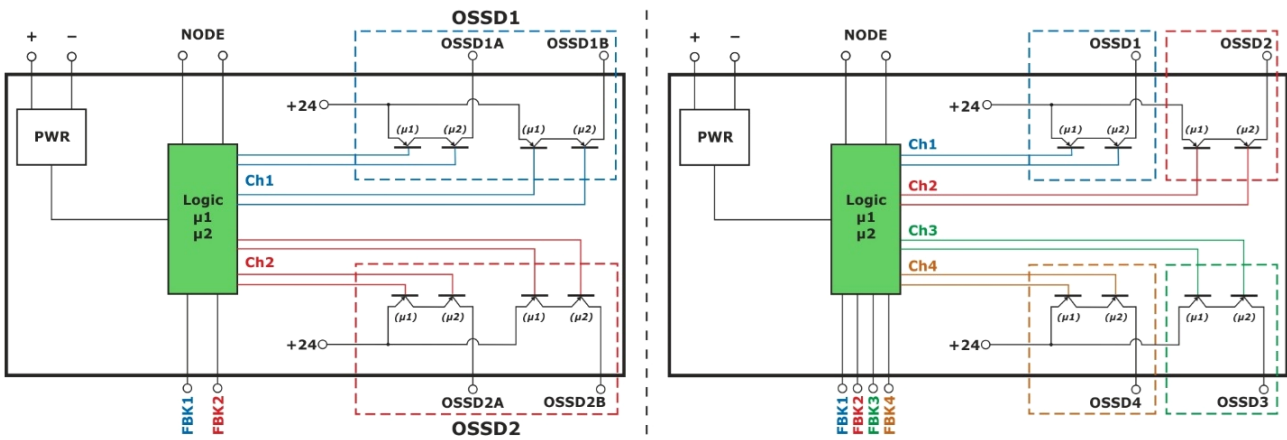

**Dual Channel OSSD**

**Single Channel OSSD**

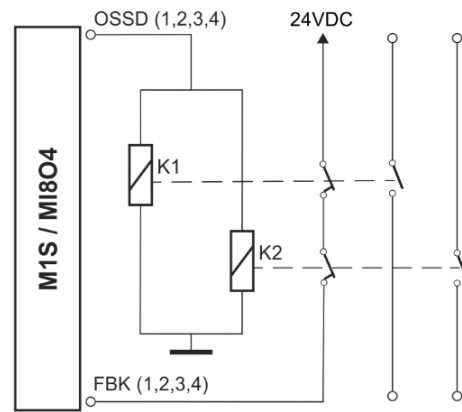
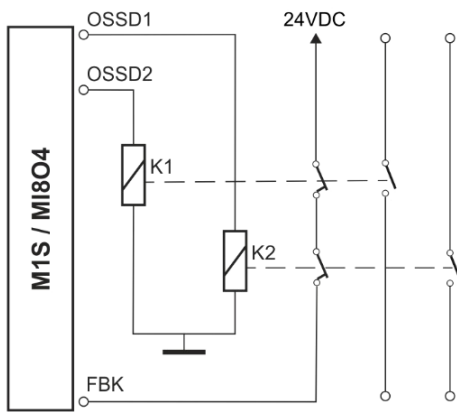

*Configuration with 2 dual channel outputs (safety category SIL3/PI e)*

*Configuration with 4 single outputs (safety category SIL3/PI e)*

### OSSD (MO4LHCS8)

MO4LHCS8 provides 4 High Current Safety Outputs single channel (**2A max per channel**). Different output configurations (configurable with MSD configuration software) can be set:

- Four single channels (1 Safety Output per channel with its relative feedback input).
- Two dual channels (2 Safety Outputs per channel with their relative feedback input).
- 1 dual channel and 2 single channels.

**Using single channels OSSD, to maintain Safety Integrity Level (SIL) "3" requirements the OSSD outputs must be independent.**  
**Common cause failures between OSSD outputs must be excluded by observing an appropriate cable installation (i.e. separate cable paths).**

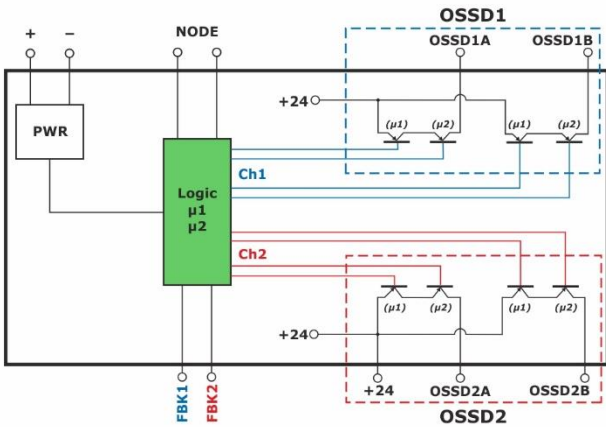

**Dual Channel OSSD**

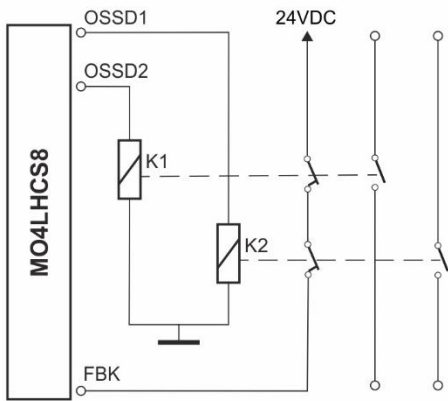

*Configuration with 2 dual channel outputs (safety category SIL3/Pl e)*

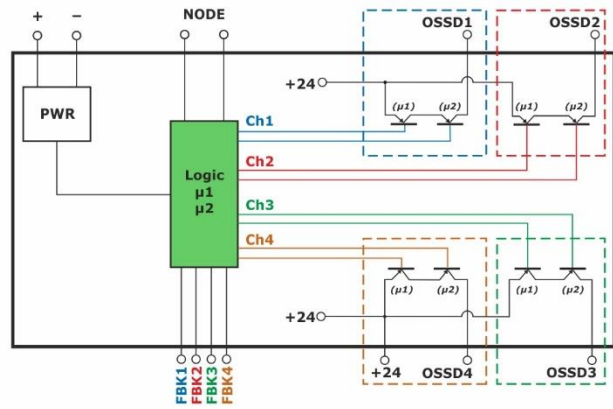

**Single Channel OSSD**

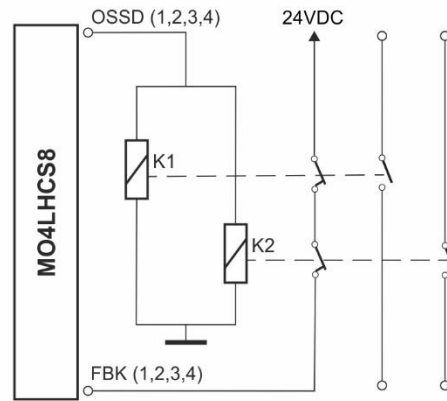

*Configuration with 4 single outputs (safety category SIL3/Pl e)*

➔ Using MO4LHCS8 with current output >500mA, separate it from adjacent modules by interposing an DSC-MSC connector.

Each OSSD output can be configured as shown in Table 21:

<b>Automatic</b>	The output is activated according to the configurations set by the MSD SW only if the corresponding RESTART_FBK input is connected to 24VDC.
<b>Manual</b>	The output is activated according to the configurations set by the MSD SW only if corresponding RESTART_FBK input FOLLOWS A LOGIC TRANSITION OF 0->1.
<b>Monitored</b>	The output is activated according to the configurations set by the MSD SW only if the corresponding RESTART_FBK input FOLLOWS A LOGIC TRANSITION OF 0->1->0.

Table 21

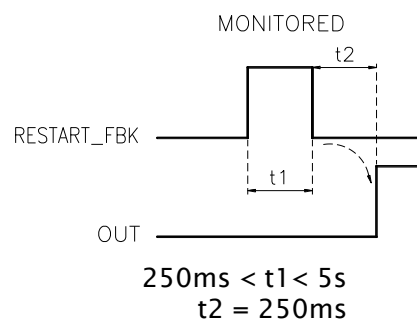
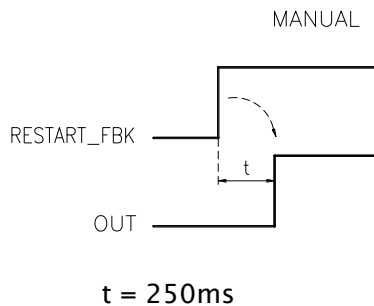

➔ It is not allowed the connection of external devices to the outputs, except as expected in the configuration performed with the MSD software.

**SAFETY RELAYS (MR2, MR4, MOR4, MOR4S8)**

**Characteristics of the output circuit.**

The MR2/MR4 units use guided contact safety relays, each of which provides **two N.O. contacts and one N.C contact in addition to the N.C. feedback contact.**

The MR2 unit uses two safety relays and the MR4 uses four.

The MOR4/MOR4S8 units use four guided-contact safety relays. Each relay provides one NO contact monitored by the module logic through internal FBK contact.

➔ Refer to the "RELAY" section to check the possible MOR4/MOR4S8 operation modes configurable with MSD software.

Excitation voltage	17...31 VDC
Minimum switchable voltage	10 VDC
Minimum switchable current	20 mA
Maximum switchable voltage (DC)	250VDC
Maximum switchable voltage (AC)	400VAC
Maximum switchable current	6A
Response time	12ms
Mechanical life of contacts	> 20 x 10 <sup>6</sup>

Table 22

➔ To guarantee correct isolation and avoid the risk of premature ageing of or damage to the relays, each output line must be protected using a fast acting 4A fuse and the load characteristics must be consistent with those specified in Table 12.

➔ See the "MR2/MR4" section (for further details on these relays).

**MR2/MR4 internal contacts diagram**

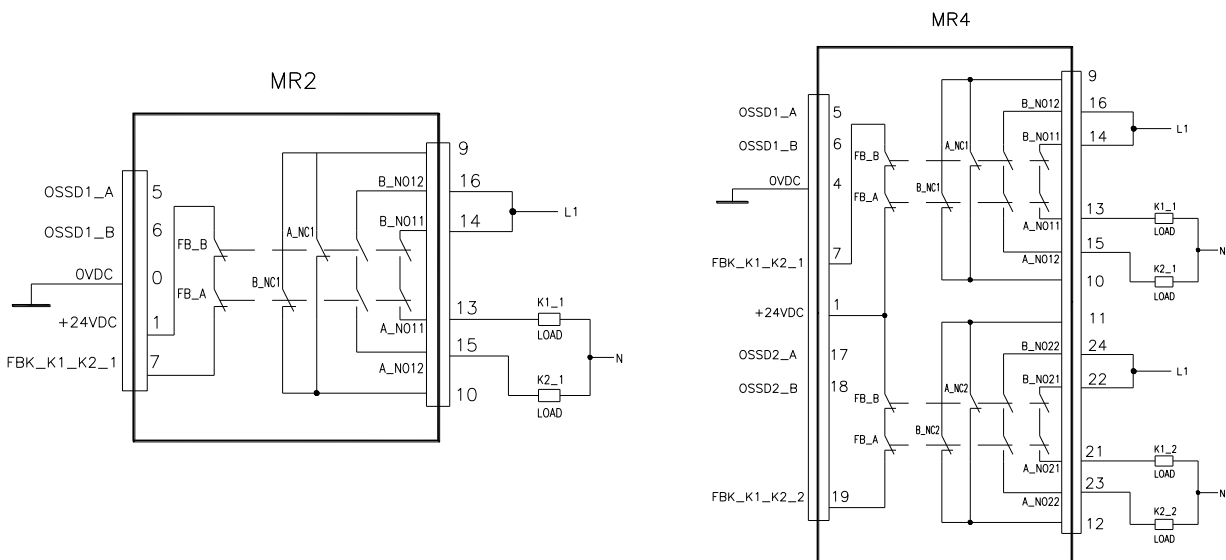

Figure 7

Example of MR2 module connection with static OSSD outputs of a module M1<sup>2</sup>

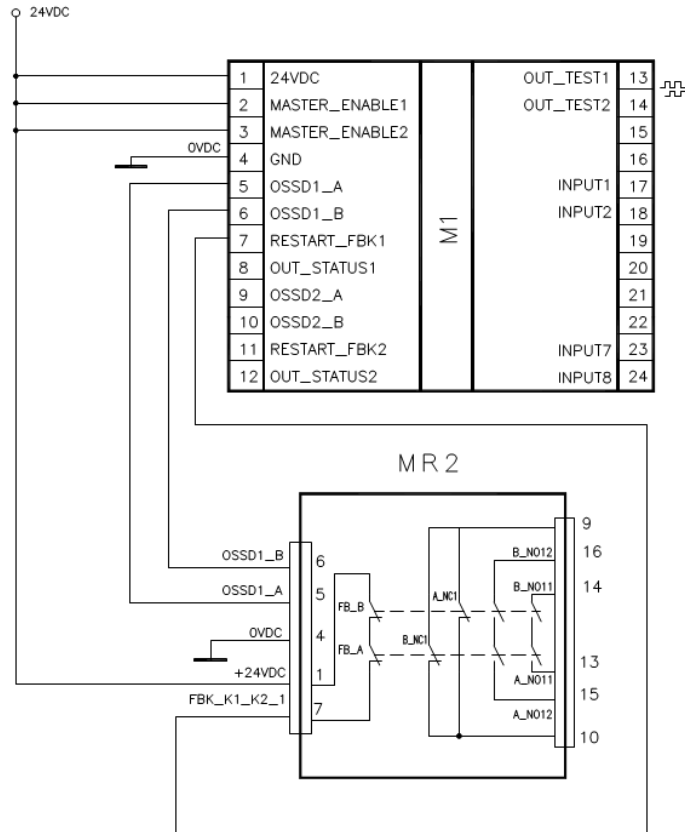

Figure 8

Switching operation timing diagram.

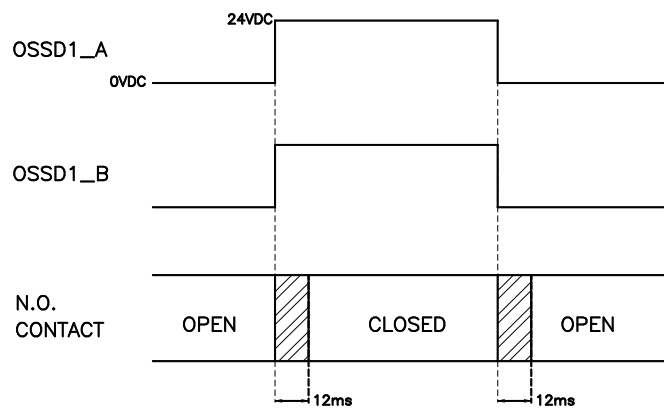

Figure 9

<sup>2</sup> If a relay module is connected, the response time of the OSSD linked, must be increased of 12ms.

## TECHNICAL FEATURES

### GENERAL SYSTEM CHARACTERISTICS

#### Safety level parameters

Parameter	Value	Standard
PFH <sub>d</sub>	See the technical data tables for each module	EN 61508:2010
SIL	3	
SFF	99,8%	
HFT	1	
Safety standard	Type B	
SILCL	3	EN 62061:2005 / A2:2015
Type	4	EN 61496-1:2013
PL	e	EN ISO 13849-1:2015 EN 62061:2005 / A2:2015
Dc <sub>avg</sub>	High	
MTTFd (years)	30 ÷ 100	
Category	4	
Device lifetime	20 years	
Pollution degree	2	

#### General data

Max number of inputs	128	
Max number of OSSD outputs	16 (M1); 32 (M1S)	
Max number of signalling outputs	32 (M1); 48 (M1S)	
Max number of slave units (excluding MR2-MR4)	14	
Max number of slave units of the same type (excluding MR2-MR4)	4	
Rated voltage	24VDC ± 20% / PELV, Protective Class III; UL: Supply from class 2 (LVLE)	
Over voltage category	II	
Digital INPUTS	PNP active high (EN 61131-2) - Max. applicable resistance 1,2kΩ	
OSSD (M1, M1S, MI8O2, MI8O4, MO2, MO4, MO4L)	PNP active high - 400mA@24VDC max (each OSSD)	
OSSD (MO4LHCS8)	PNP active high - 2A@24VDC max (each OSSD)	
Relais OUTPUTS (MOR4, MOR4S8)	6A max@240Vac max (each relais)	
Signaling OUTPUTS (M1, M1S, MI8O2, MI8O4, MO2, MO4, MO4L, MOR4S8, MO4LHCS8, MOS8, MOS16)	PNP active high - 100mA@24VDC max	
<p><b>Response time M1 (ms)</b></p> <p><i>This response times depends on the following parameters:</i></p> <p>1) Number of Slave modules installed 2) Number of Operators 3) Number of OSSD outputs</p> <p><i>For the right response time refer to the one calculated by the DSD software (see Project report)</i></p> <p><b>Failure Response time M1 (ms)</b></p> <p><i>This parameter corresponds to the response time, with the exception of MV modules with Encoder/Proximity interface where is 2s</i></p>	Master	10,6 ÷ 12,6 + T <sub>Input_filter</sub>
	M1 + 1 Slave	11,8 ÷ 26,5 + T <sub>Input_filter</sub>
	M1 + 2 Slaves	12,8 ÷ 28,7 + T <sub>Input_filter</sub>
	M1 + 3 Slaves	13,9 ÷ 30,8 + T <sub>Input_filter</sub>
	M1 + 4 Slaves	15 ÷ 33 + T <sub>Input_filter</sub>
	M1 + 5 Slaves	16 ÷ 35 + T <sub>Input_filter</sub>
	M1 + 6 Slaves	17 ÷ 37,3 + T <sub>Input_filter</sub>
	M1 + 7 Slaves	18,2 ÷ 39,5 + T <sub>Input_filter</sub>
	M1 + 8 Slaves	19,3 ÷ 41,7 + T <sub>Input_filter</sub>
	M1 + 9 Slaves	20,4 ÷ 43,8 + T <sub>Input_filter</sub>
	M1 + 10 Slaves	21,5 ÷ 46 + T <sub>Input_filter</sub>
	M1 + 11 Slaves	22,5 ÷ 48,1 + T <sub>Input_filter</sub>
	M1 + 12 Slaves	23,6 ÷ 50,3 + T <sub>Input_filter</sub>
	M1 + 13 Slaves	24,7 ÷ 52,5 + T <sub>Input_filter</sub>
	M1 + 14 Slaves	25,8 ÷ 54,6 + T <sub>Input_filter</sub>



<p><b>Response time M1S (ms)</b></p> <p><i>This response times depends on the following parameters:</i></p> <p>1) Number of Slave modules installed 2) Number of Operators 3) Number of OSSD outputs</p> <p><i>For the right response time refer to the one calculated by the DSD software (see Project report)</i></p> <p><b>Failure Response time M1S (ms)</b></p> <p><i>This parameter corresponds to the response time, with the exception of MV modules with Encoder/Proximity interface where is 2s</i></p>	Master	12,75 ÷ 14,75 + T <sub>Input_filter</sub>
	M1S + 1 Slave	13,83 ÷ 37,84 + T <sub>Input_filter</sub>
	M1S + 2 Slaves	14,91 ÷ 40,00 + T <sub>Input_filter</sub>
	M1S + 3 Slaves	15,99 ÷ 42,16 + T <sub>Input_filter</sub>
	M1S + 4 Slaves	17,07 ÷ 44,32 + T <sub>Input_filter</sub>
	M1S + 5 Slaves	18,15 ÷ 46,48 + T <sub>Input_filter</sub>
	M1S + 6 Slaves	19,23 ÷ 48,64 + T <sub>Input_filter</sub>
	M1S + 7 Slaves	20,31 ÷ 50,80 + T <sub>Input_filter</sub>
	M1S + 8 Slaves	21,39 ÷ 52,96 + T <sub>Input_filter</sub>
	M1S + 9 Slaves	22,47 ÷ 55,12 + T <sub>Input_filter</sub>
	M1S + 10 Slaves	23,55 ÷ 57,28 + T <sub>Input_filter</sub>
	M1S + 11 Slaves	24,63 ÷ 59,44 + T <sub>Input_filter</sub>
	M1S + 12 Slaves	25,71 ÷ 61,60 + T <sub>Input_filter</sub>
	M1S + 13 Slaves	26,79 ÷ 63,76 + T <sub>Input_filter</sub>
	M1S + 14 Slaves	27,87 ÷ 65,92 + T <sub>Input_filter</sub>
<b>M1 - M1S -&gt; module connection</b>	Duelco proprietary 5-pole bus (DSC-MSC)	
<b>Connection cable cross-section</b>	0,5 ÷ 2,5 mm <sup>2</sup> / AWG 12÷30 (solid/stranded)	
<b>Max length of connections</b>	100m	
<b>Operating temperature</b>	-10 ÷ 55°C	
<b>Max surrounding air temperature</b>	55°C (UL)	
<b>Storage temperature</b>	-20 ÷ 85°C	
<b>Relative humidity</b>	10% ÷ 95%	
<b>Max. altitude (above sea level)</b>	2000 m	

➔ T<sub>Input\_filter</sub> = max filtering time from among those set on project inputs (see "INPUTS" section).

## Enclosure

<b>Description</b>	Electronic housing max 24 pole, with locking latch mounting
<b>Enclosure material</b>	Polyamide
<b>Enclosure protection class</b>	IP 20
<b>Terminal blocks protection class</b>	IP 2X
<b>Fastening</b>	Quick coupling to rail according to EN 60715
<b>Dimensions (h x l x d)</b>	108 x 22.5 x 114.5

## M1 module

<b>PFH<sub>d</sub> (IEC 61508:2010)</b>	6.86E-9
<b>Rated voltage</b>	24VDC ± 20%
<b>Dissipated power</b>	3W max
<b>Unit enable (No./description)</b>	2 / PNP active high "type B" according to EN 61131-2
<b>Digital INPUTS (No./description)</b>	8 / PNP active high according to EN 61131-2
<b>INPUT FBK/RESTART (No./description)</b>	2 / EDM control / possible Automatic or Manual operation with RESTART button
<b>Test OUTPUT (No./description)</b>	4 / to check for short-circuits - overloads
<b>Signaling OUTPUTS (No./description)</b>	2 / programmable - PNP active high
<b>OSSD (No./description)</b>	2 pairs / solid state safety outputs PNP active high 400mA@24VDC max - Interface type C class 3 (ZVEI CB24I)
<b>SLOT for DSC-MCM card</b>	Available
<b>Connection to PC</b>	USB 2.0 (Hi Speed) - Max cable length: 3m
<b>Connection to slave units</b>	via DSC-MSC 5-way Duelco proprietary bus

## M1S module

PFH <sub>d</sub> (IEC 61508:2010)	1,35E-08
Rated voltage	24VDC ± 20%
Dissipated power	3W max
Digital INPUTS (No./description)	8 / PNP active high according to EN 61131-2
INPUT FBK/RESTART (No./description)	4 / EDM control / possible Automatic or Manual operation with RESTART button
Test OUTPUT (No./description)	4 / to check for short-circuits - overloads
Signaling OUTPUTS (No./description)	4 / programmable - PNP active high
OSSD (No./description)	4 single / solid state safety outputs PNP active high 400mA@24VDC max Interface type C class 3 (ZVEI CB24I)
SLOT for DSC-MCM card	Available
Connection to PC	USB 2.0 (Hi Speed) - Max cable length: 3m
Connection to slave units	via DSC-MSC 5-way Duelco proprietary bus

## MI8O2 module

PFH <sub>d</sub> (IEC 61508:2010)	5.67E-9
Rated voltage	24VDC ± 20%
Dissipated power	3W max
Digital INPUTS (No./description)	8 / PNP active high according to EN 61131-2
Test OUTPUT (No./description)	4 / to check for short-circuits - overloads
Signaling OUTPUTS (No./description)	2 / programmable - PNP active high
OSSD (No./description)	2 pairs / solid state safety outputs: PNP active high - 400mA@24VDC max Interface type C class 3 (ZVEI CB24I)
Connection to M1 and M1S	via DSC-MSC 5-way Duelco proprietary bus

## MI8O4 module

PFH <sub>d</sub> (IEC 61508:2010)	1,32E-08
Rated voltage	24VDC ± 20%
Dissipated power	3W max
Digital INPUTS (No./description)	8 / PNP active high according to EN 61131-2
Test OUTPUT (No./description)	4 / to check for short-circuits - overloads
Signaling OUTPUTS (No./description)	4 / programmable - PNP active high
OSSD (No./description)	4 single / solid state safety outputs: PNP active high - 400mA@24VDC max Interface type C class 3 (ZVEI CB24I)
Connection to M1S	via DSC-MSC 5-way Duelco proprietary bus

**MI8 - MI16 modules**

Model	MI8	MI16
PFH <sub>d</sub> (IEC 61508:2010)	4.46E-9	4.93E-9
Rated voltage	24VDC ± 20%	
Dissipated power	3W max	
Digital INPUTS (No./description)	8	16
	PNP active high according to EN 61131-2	
Test OUTPUT (No./description)	4 / to check for short-circuits - overloads	
Connection to M1 and M1S	via DSC-MSD 5-way Duelco proprietary bus	

**MI12T8 module**

PFH <sub>d</sub> (IEC 61508:2010)	5,60E-09
Rated voltage	24VDC ± 20%
Dissipated power	3W max
Digital INPUTS (No./description)	12
	PNP active high according to EN 61131-2
Test OUTPUT (No./description)	8 / to check for short-circuits - overloads
Connection to M1 and M1S	via DSC-MSD 5-way Duelco proprietary bus

**MO2 - MO4 modules**

Model	MO2	MO4
PFH <sub>d</sub> (IEC 61508:2010)	4,08E-09	5,83E-09
Rated voltage	24VDC ± 20%	
Dissipated power	3W max	
Signaling OUTPUTS (No./description)	2	4
	programmable - PNP active high	
OSSD (No./description)	2	4
	Solid state safety outputs: PNP active high 400mA@24VDC max Interface type C class 3 (ZVEI CB24I)	
Connection to M1 and M1S	via DSC-MSD 5-way Duelco proprietary bus	

**MO4L module**

PFH <sub>d</sub> (IEC 61508:2010)	1,12E-08
Rated voltage	24VDC ± 20%
Dissipated power	3W max
Signaling OUTPUTS (No./description)	4 / programmable - PNP active high
OSSD (No./description)	4 single / solid state safety outputs: PNP active high - 400mA@24VDC max - Interface type C class 3 (ZVEI CB24I)
Connection to M1S	via DSC-MSD 5-way Duelco proprietary bus

MOS8 – MOS16 modules

Model	MOS8	MOS16
Rated voltage	24VDC ± 20%	
Dissipated power	3W max	
Signaling OUTPUT (No./description)	8	16
Connection to M1 and M1S	programmable - PNP active high through 5-way DSC-MSC proprietary bus	

MR2 - MR4 modules

Model	MR2	MR4
Rated voltage	24VDC ± 20%	
Dissipated power	3W max	
Switching voltage	240 VAC	
Switching current	6A max	
N.O. contacts	2 N.O. + 1 N.C.	4 N.O. + 2 N.C.
FEEDBACK contacts	1	2
Response time	12ms	
Mechanical life of contacts	> 20 x 10 <sup>6</sup>	
Connection to output module	Via front-panel terminal strip (no connection via DSC-MSC bus)	

MR2 – MR4: TECHNICAL DATA CONCERNING SAFETY											
FEEDBACK CONTACT PRESENT						FEEDBACK CONTACT MISSING					
PFHd	SFF	MTTFd	DCavg			PFHd	SFF	MTTFd	DCavg		
3,09E-10	99,6%	2335,94	98,9%	tcycle1	DC13 (2A)	9,46E-10	60%	2335,93	0	tcycle1	DC13 (2A)
8,53E-11	99,7%	24453,47	97,7%	tcycle2		1,08E-10	87%	24453,47	0	tcycle2	
6,63E-11	99,8%	126678,49	92,5%	tcycle3		6,75E-11	97%	126678,5	0	tcycle3	
8,23E-09	99,5%	70,99	99,0%	tcycle1	AC15 (3A)	4,60E-07	50%	70,99	0	tcycle1	AC15 (3A)
7,42E-10	99,5%	848,16	99,0%	tcycle2		4,49E-09	54%	848,15	0	tcycle2	
1,07E-10	99,7%	12653,85	98,4%	tcycle3		1,61E-10	79%	12653,85	0	tcycle3	
3,32E-09	99,5%	177,38	99,0%	tcycle1	AC15 (1A)	7,75E-08	51%	177,37	0	tcycle1	AC15 (1A)
3,36E-10	99,6%	2105,14	98,9%	tcycle2		1,09E-09	60%	2105,14	0	tcycle2	
8,19E-11	99,7%	28549,13	97,5%	tcycle3		1,00E-10	88%	28549,13	0	tcycle3	

tcycle1: 300s (1 commutation every 5 minutes)

tcycle2: 3600s (1 commutation every hour)

tcycle3: 1 commutation every day

(PFHd according IEC61508, MTTFd and DCavg according ISO13849-1)

MOR4 – MOR4S8 module

Model	MOR4	MOR4S8
PFH <sub>d</sub> (IEC 61508:2010)	2,72E-09	1,30E-08
Rated voltage	24VDC ± 20%	
Dissipated power <b>max</b>	3W max	
Switching voltage	240 VAC	
Switching current	6A max	
N.O. contacts	4	
INPUT FBK/RESTART (No./description)	4 / EDM control / possible Automatic or Manual operation with RESTART button	
Digital OUTPUT (No./description)	-	8 / Programmable output PNP active high
Response time	12ms	
Mechanical life of contacts	> 40 x 10 <sup>6</sup>	
Connection to M1 and M1S	via DSC-MSC 5-way Duelco proprietary bus	

### MO4LHCS8 module

PFH <sub>d</sub> (IEC 61508:2010)	8,64E-09
Rated voltage	24VDC ± 20%
Dissipated power <b>max</b>	4W max
OSSD output current	2A max per channel *
Number of Safety Outputs (OSSD)	4 single channels (or 2 dual channels), cat.4 Interface type C class 3 (ZVEI CB24I)
INPUT FBK/RESTART (No./description)	4 / EDM control / possible Automatic or Manual operation with RESTART button
Digital OUTPUT (No./description)	8 / Programmable output / PNP active high
Response time	12ms
Connection to M1 and M1S	via DSC-MSC 5-way Duelco proprietary bus

\* Using MO4LHCS8 with current output >500mA, separate it from adjacent modules by interposing an DSC-MSC connector.

### MV0 - MV1 - MV2 modules

Condition (-> SPEED CONTROL TYPE FUNCTION BLOCKS)	Overspeed	Stand still	Window speed
Safe state	Overspeed	NO Stand still	Out of Window speed

Model	MV0	MV1	MV2
PFH <sub>d</sub>	7,36E-09	-	-
PFH <sub>d</sub> (TTL)	-	8,46E-09 (MV1T)	9,56E-09 (MV2T)
PFH <sub>d</sub> (sin/cos)	-	9,31E-09 (MV1S)	1,13E-08 (MV2S)
PFH <sub>d</sub> (HTL24)	-	8,08E-09 (MV1H)	8,80E-09 (MV2H)
PFH <sub>d</sub> (TTL internal power supply)	-	9,20E-09 (MV1TB)	1,10E-08 (MV2TB)
Rated Voltage	24VDC ± 20%		
Dissipated power <b>max</b>	3W		
Input impedance	-	120 ohm (MV1T - MV1TB / MV2T - MV2TB models) 120 ohm (MV1S - MV2S models)	
Encoder Interface	-	TTL (MV1T - MV1TB / MV2T - MV2TB models) HTL (MV1H - MV2H models) sin/cos (MV1S - MV2S models)	
Encoder connections	-	RJ45 connector	
Encoder input signals electrically insulated in accordance with EN 61800-5	-	Rated insulation voltage 250V Overvoltage category II Rated impulse withstand voltage 4.00 kV	
Max number of encoders	-	1	2
Max encoder frequency	-	500KHz (HTL: 300KHz)	
Encoder adjustable threshold range	-	1Hz ÷ 450KHz	
Proximity type	PNP/NPN - 3/4 wires		
Proximity connections	Terminal blocks		
Proximity adjustable threshold range	1Hz ÷ 4KHz		
Max number of proximity	2		
Max proximity frequency	5KHz		
Max number of axes	2		
Stand-still/overspeed frequency gap	>10Hz		
Min. gap between thresholds (with thresholds >1)	> 5%		
M1 connections and M1S	via DSC-MSC 5-way Duelco proprietary bus		

MA4 module

PFH <sub>d</sub> (IEC 61508:2010)	1,53E-8
Rated voltage	24VDC ± 20%
Max dissipated power	5W
Channels number	4, fully isolated (500 VDC) Each channel can be configured as Voltage input or Current input
Current output sensors	
Range	4...20 mA (0-20 mA)
Conversion bits	16
Resolution (minimum current variation releable)	381 nA
Sample rate (Samples per second)	User selectable. Allowable values: 2.5, 5, 10, 16.6, 20, 50, 60, 100, 200, 400, 800, 1000, 2000, 4000
Input impedance	200 Ohm
Max input current	23 mA
Voltage output sensors	
Range	0...10 VDC
Conversion bits	16
Resolution (minimum voltage variation releable)	152 µV
Sample rate (Samples per second)	User selectable. Allowable values: 2.5, 5, 10, 16.6, 20, 50, 60, 100, 200, 400, 800, 1000, 2000, 4000
Input impedance	250 kOhm
Diagnostic	
Isolated sensor power supply overload (if the sensor draws more than 60 mA)	<b>YES with active protection.</b> <i>When this condition is detected the power supply of the sensor is disconnected for 1 second and then again activated to check if the overload condition still exist in an endless loop until the overload condition disappear.</i>
Input overvoltage / input overcurrent	<b>YES with active protection.</b> <i>When this condition is detected the power supply of the sensor is disconnected for 1 second and then again activated to check if the input overvoltage/overcurrent condition still exist in an endless loop until the anomaly disappear.</i>
Disconnected cable detection	YES
Overthreshold / Underthreshold detection	YES
Connection to M1S	via DSC-MSC 5-way Duelco proprietary bus

## MECHANICAL DIMENSIONS

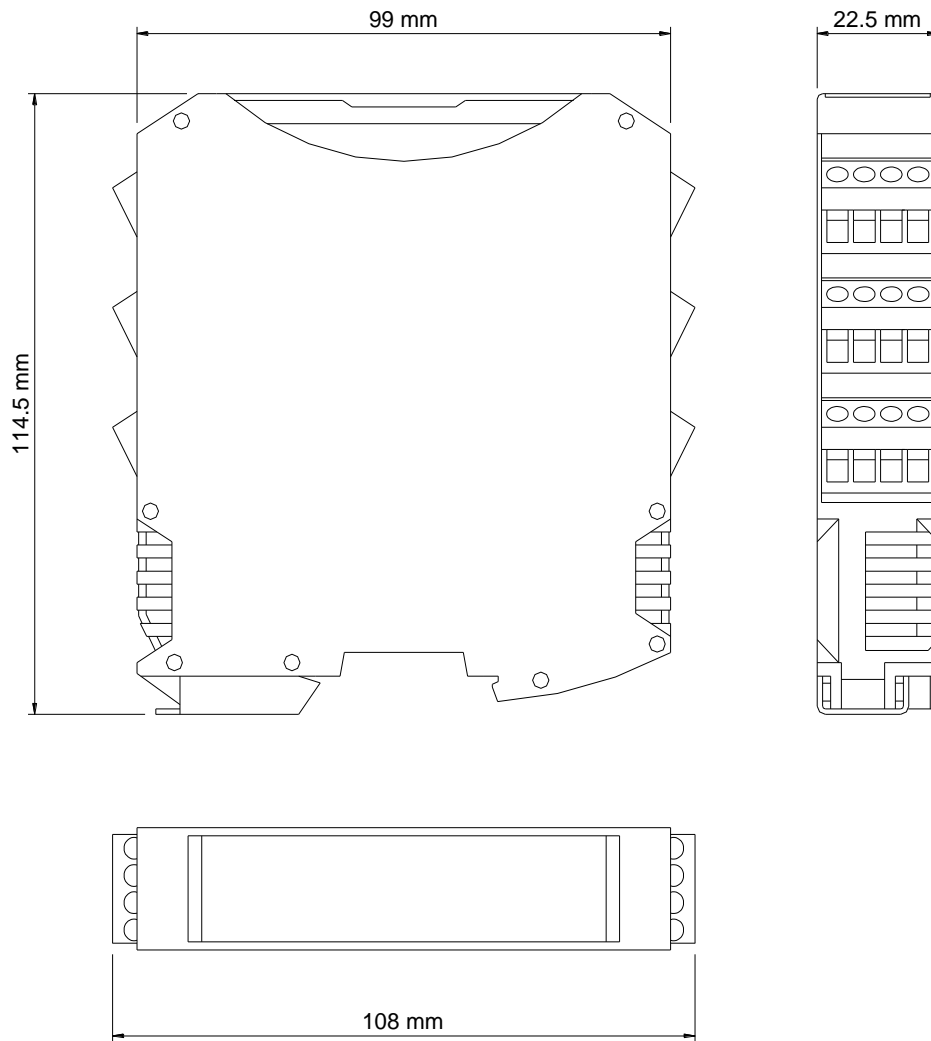

Figure 10

**SIGNALS**

Master M1 (Figure 11)

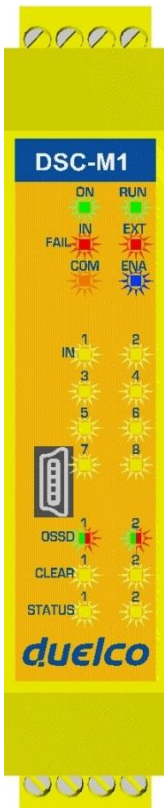

Figure 11 - M1

MEANING	LED									
	RUN GREEN	IN FAIL RED	EXT FAIL RED	COM ORANGE	ENA BLUE	IN1÷8 YELLOW	OSSD1/2 RED/GREEN	CLEAR1/2 YELLOW	STATUS1/2 YELLOW	
Power on - initial TEST	ON	ON	ON	ON	ON	ON	Red	ON	ON	
DSC-MCM recognised	OFF	OFF	OFF	ON (max 1s)	ON (max 1s)	OFF	Red	OFF	OFF	
Writing/loading/ diagram to/from DSC-MCM card	OFF	OFF	OFF	5 flashes	5 flashes	OFF	Red	OFF	OFF	
MSD requesting connection: internal configuration not present	OFF	OFF	OFF	Flashes slowly	OFF	OFF	Red	OFF	OFF	
MSD requesting connection: (slave module or node number not correct) (ref. System composition)	OFF	OFF	OFF	Flashes quickly	OFF	OFF	Red	OFF	OFF	
MSD requesting connection: (slave module missing or not ready) (ref. System composition)	Flashes quickly	OFF	OFF	Flashes quickly	OFF	OFF	Red	OFF	OFF	
MSD connected M1 stopped	OFF	OFF	OFF	ON	OFF	OFF	Red	OFF	OFF	

Table 23 - Opening Screen

MEANING	LED									
	RUN GREEN	IN FAIL RED	EXT FAIL RED	COM ORANGE	IN1÷8 YELLOW	ENA BLUE	OSSD1/2 RED/GREEN	CLEAR1/2 YELLOW	STATUS1/2 YELLOW	
NORMAL OPERATION	ON	OFF	OFF op. OK	ON = M1 connected to PC OFF=otherwise	INPUT condition	ON MASTER_ENABLE1 and MASTER_ENABLE2 active OFF otherwise	RED with output OFF	ON waiting for RESTART	OUTPUT condition	
EXTERNAL FAULT DETECTED	ON	OFF	ON incorrect external connection detected	ON = M1 connected to PC OFF=otherwise	only the number of the INPUT with the incorrect connection flashes	ON MASTER_ENABLE1 and MASTER_ENABLE2 active OFF otherwise	GREEN with output ON	Flashing NO feedback	OUTPUT condition	

Table 24 - Dynamic Screen

English



Master M1S (Figure 11)



Figure 12 - M1S

MEANING	LED							
	RUN GREEN	IN FAIL RED	EXT FAIL RED	COM ORANGE	ENA BLUE	IN1÷8 YELLOW	OSSD1/4 RED/GREEN/YELLOW	STATUS1/4 YELLOW
Power on - initial TEST	ON	ON	ON	ON	ON	ON	Red	ON
DSC-MCM recognised	OFF	OFF	OFF	ON (max 1s)	ON (max 1s)	OFF	Red	OFF
Writing/loading/ diagram to/from DSC-MCM card	OFF	OFF	OFF	5 flashes	5 flashes	OFF	Red	OFF
MSD requesting connection: internal configuration not present	OFF	OFF	OFF	Flashes slowly	OFF	OFF	Red	OFF
MSD requesting connection: (slave module or node number not correct) (ref. System composition)	OFF	OFF	OFF	Flashes quickly	OFF	OFF	Red	OFF
MSD requesting connection: (slave module missing or not ready) (ref. System composition)	Flashes quickly	OFF	OFF	Flashes quickly	OFF	OFF	Red	OFF
MSD connected M1 stopped	OFF	OFF	OFF	ON	OFF	OFF	Red	OFF

Table 25 - Opening Screen

MEANING	LED							
	RUN GREEN	IN FAIL RED	EXT FAIL RED	COM ORANGE	IN1÷8 YELLOW	ENA BLUE	OSSD1/4 RED/GREEN/YELLOW	STATUS1/4 YELLOW
NORMAL OPERATION	ON	OFF	OFF op. OK	ON = M1 connected to PC OFF=otherwise	INPUT condition	ON	RED with output OFF GREEN with output ON YELLOW waiting for restart BLINKING YELLOW with inconsistent feedback (if required)	OUTPUT condition
EXTERNAL FAULT DETECTED	ON	OFF	ON incorrect external connection detected	ON = M1 connected to PC OFF=otherwise	only the number of the INPUT with the incorrect connection flashes			

Table 26 - Dynamic Screen

MI802 (Figure 13)

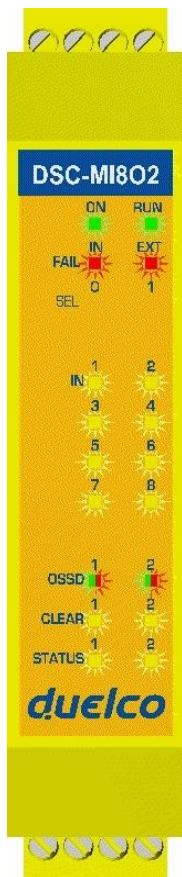

MEANING	LED							
	RUN GREEN	IN FAIL RED	EXT FAIL RED	SELO/1 ORANGE	IN1÷8 YELLOW	OSSD1/2 RED/GREEN	CLEAR1/2 YELLOW	STATUS1/2 YELLOW
Power on - initial TEST	ON	ON	ON	ON	ON	Red	ON	ON

Table 27 - Opening Screen

MEANING	LED							
	RUN GREEN	IN FAIL RED	EXT FAIL RED	IN1÷8 YELLOW	SELO/1 ORANGE	OSSD1/2 RED/GREEN	CLEAR1/2 YELLOW	STATUS1/2 YELLOW
NORMAL OPERATION	OFF if the unit is waiting for the first communication from the MASTER	OFF	OFF	INPUT condition	Shows the NODE_SELO/1 signal table	RED with output OFF GREEN with output ON	ON waiting for RESTART  Flashes NO feedback	OUTPUT condition
	FLASHES if no INPUT or OUTPUT requested by the configuration		ON incorrect external connection detected	only the number of the INPUT with the incorrect connection flashes				
	ON if INPUT or OUTPUT requested by the configuration							

Table 28 - Dynamic Screen

Figure 13 - MI802

MI804 (Figure 13)

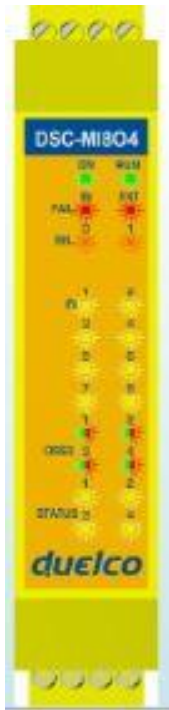

Figure 14 - MI804

MEANING	LED						
	RUN GREEN	IN FAIL RED	EXT FAIL RED	SEL0/1 ORANGE	IN1÷8 YELLOW	OSSD1/4 RED/GREEN/YELLOW	STATUS1/4 YELLOW
Power on - initial TEST	ON	ON	ON	ON	ON	Red	ON

Table 29 - Opening Screen

MEANING	LED						
	RUN GREEN	IN FAIL RED	EXT FAIL RED	IN1÷8 YELLOW	SEL0/1 ORANGE	OSSD1/4 RED/GREEN/YELLOW	STATUS1/4 YELLOW
NORMAL OPERATION	OFF if the unit is waiting for the first communication from the MASTER	OFF	OFF	INPUT condition	Shows the NODE_SEL0/1 signal table	RED with output OFF GREEN with output ON YELLOW waiting for restart BLINKING YELLOW with inconsistent feedback (if required)	OUTPUT condition
	FLASHES if no INPUT or OUTPUT requested by the configuration		ON incorrect external connection detected	only the number of the INPUT with the incorrect connection flashes			
	ON if INPUT or OUTPUT requested by the configuration						

Table 30 - Dynamic Screen

MI8 (Figure 15)

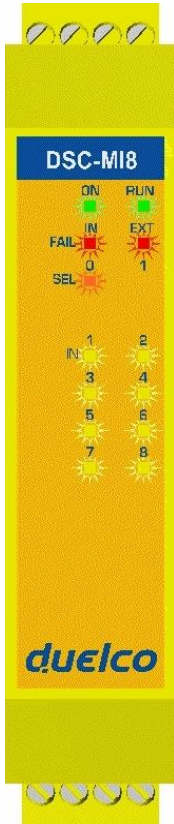

MEANING	LED				
	RUN GREEN	IN FAIL RED	EXT FAIL RED	SELO/1 ORANGE	IN1÷8 YELLOW
Power on - initial TEST	ON	ON	ON	ON	ON

Table 31 - Opening Screen

MEANING	LED				
	RUN GREEN	IN FAIL RED	EXT FAIL RED	SELO/1 ORANGE	IN1÷8 YELLOW
NORMAL OPERATION	OFF if the unit is waiting for the first communication from the MASTER	OFF	OFF	Shows the NODE_SELO/1 signal table	INPUT condition
	FLASHES if no INPUT or OUTPUT requested by the configuration		ON incorrect external connection detected		only the number of the INPUT with the incorrect connection flashes
	ON if INPUT or OUTPUT requested by the configuration				

Table 32 - Dynamic Screen

Figure 15 - MI8

MI12T8 (Figure 17)

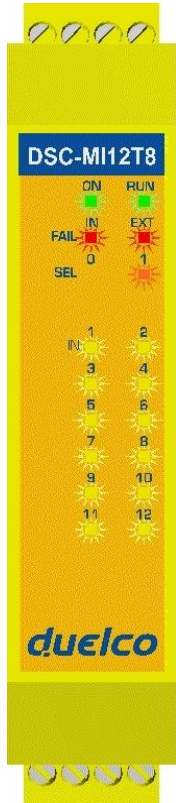

Figure 16-MI12T8

MEANING	LED				
	RUN GREEN	IN FAIL RED	EXT FAIL RED	SEL0/1 ORANGE	IN1÷12 YELLOW
Power on - initial TEST	ON	ON	ON	ON	ON

Table 33 - Opening Screen

MEANING	LED				
	RUN GREEN	IN FAIL RED	EXT FAIL RED	SEL0/1 ORANGE	IN1÷12 YELLOW
NORMAL OPERATION	OFF if the unit is waiting for the first communication from the MASTER	OFF	OFF	Shows the NODE_SEL0/1 signal table	INPUT condition
	FLASHES if no INPUT or OUTPUT requested by the configuration		ON incorrect external connection detected		only the number of the INPUT with the incorrect connection flashes
	ON if INPUT or OUTPUT requested by the configuration				

Table 34 - Dynamic Screen

MI16 (Figure 17)

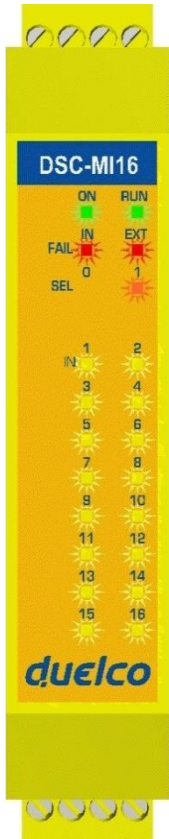

MEANING	LED				
	RUN GREEN	IN FAIL RED	EXT FAIL RED	SEL0/1 ORANGE	IN1÷16 YELLOW
Power on - initial TEST	ON	ON	ON	ON	ON

Table 35 - Opening Screen

MEANING	LED				
	RUN GREEN	IN FAIL RED	EXT FAIL RED	SEL0/1 ORANGE	IN1÷16 YELLOW
NORMAL OPERATION	OFF if the unit is waiting for the first communication from the MASTER	OFF	OFF	Shows the NODE_SEL0/1 signal table	INPUT condition
	FLASHES if no INPUT or OUTPUT requested by the configuration		ON incorrect external connection detected		only the number of the INPUT with the incorrect connection flashes
ON if INPUT or OUTPUT requested by the configuration					

Table 36 - Dynamic Screen

Figure 17 - MI16

MO2 (Figure 18)

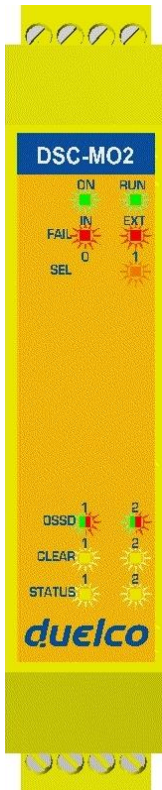

Figure 18 - MO2

MEANING	LED						
	RUN GREEN	IN FAIL RED	EXT FAIL RED	SEL0/1 ORANGE	OSDD1/2 RED/GREEN	CLEAR1/2 YELLOW	STATUS1/2 YELLOW
Power on - initial TEST	ON	ON	ON	ON	Red	ON	ON

Table 37 - Opening screen

MEANING	LED						
	RUN GREEN	IN FAIL RED	EXT FAIL RED	SEL0/1 ORANGE	OSDD1/2 RED/GREEN	CLEAR1/2 YELLOW	STATUS1/2 YELLOW
<b>NORMAL OPERATION</b>	<b>OFF</b> if the unit is waiting for the first communication from the MASTER  <b>FLASHES</b> if no INPUT or OUTPUT requested by the configuration  <b>ON</b> if INPUT or OUTPUT requested by the configuration	<b>OFF</b> op. OK	<b>OFF</b> op. OK	Shows the NODE_SEL0/1 signal table	<b>RED</b> with output OFF  <b>GREEN</b> with output ON	<b>ON</b> waiting for RESTART  <b>Flashes</b> NO feedback	OUTPUT condition

Table 38 - Dynamic screen

MO4 (Figure 19)

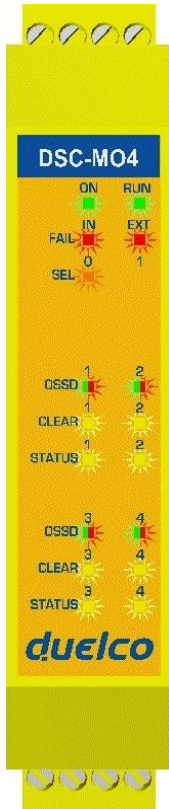

MEANING	LED						
	RUN GREEN	IN FAIL RED	EXT FAIL RED	SEL0/1 ORANGE	OSSD1/4 RED/GREEN	CLEAR1/4 YELLOW	STATUS1/4 YELLOW
Power on - initial TEST	ON	ON	ON	ON	Red	ON	ON

Table 39 - Opening screen

MEANING	LED						
	RUN GREEN	IN FAIL RED	EXT FAIL RED	SEL0/1 ORANGE	OSSD1/4 RED/GREEN	CLEAR1/4 YELLOW	STATUS1/4 YELLOW
<b>NORMAL OPERATION</b>	<p><b>OFF</b> if the unit is waiting for the first communication from the MASTER</p> <p><b>FLASHES</b> if no INPUT or OUTPUT requested by the configuration</p> <p><b>ON</b> if INPUT or OUTPUT requested by the configuration</p>	<p><b>OFF</b> op. OK</p>	<p><b>OFF</b> op. OK</p>	Shows the NODE_SEL0/1 signal table	<p><b>RED</b> with output OFF</p> <p><b>GREEN</b> with output ON</p>	<p><b>ON</b> waiting for RESTART</p> <p><b>Flashes</b> NO feedback</p>	OUTPUT condition

Table 40 - Dynamic Screen

Figure 19 - MO4



MO4L (Figure 13)

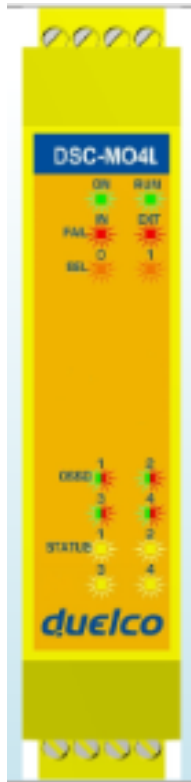

Figure 20 - MO4L

MEANING	LED					
	RUN GREEN	IN FAIL RED	EXT FAIL RED	SELO/1 ORANGE	OSSD1/4 RED/GREEN/YELLOW	STATUS1/4 YELLOW
Power on - initial TEST	ON	ON	ON	ON	Red	ON

Table 41 - Opening Screen

MEANING	LED					
	RUN GREEN	IN FAIL RED	EXT FAIL RED	SELO/1 ORANGE	OSSD1/4 RED/GREEN/YELLOW	STATUS1/4 YELLOW
NORMAL OPERATION	OFF if the unit is waiting for the first communication from the MASTER	OFF	OFF	Shows the NODE_SELO/1 signal table	RED with output OFF GREEN with output ON YELLOW waiting for restart BLINKING YELLOW with inconsistent feedback (if required)	OUTPUT condition
	FLASHES if no INPUT or OUTPUT requested by the configuration		ON incorrect external connection detected			
	ON if INPUT or OUTPUT requested by the configuration					

Table 42 - Dynamic screen

MOR4 (Figure 21)



Figure 21 - MOR4

MEANING	LED						
	RUN	IN FAIL	EXT FAIL	SELO/1	RELAY 1/4		CLEAR1/4
	GREEN	RED	RED	ORANGE	RED	GREEN	YELLOW
Power on - initial TEST	ON	ON	ON	ON	Red		ON

Table 43 - Opening screen

MEANING	LED						
	RUN	IN FAIL	EXT FAIL	SELO/1	RELAY 1/4		CLEAR1/4
	GREEN	RED	RED	ORANGE	RED	GREEN	YELLOW
NORMAL OPERATION	OFF if the unit is waiting for the first communication from the MASTER	OFF operation OK	OFF operation OK	Shows the NODE_SELO/1 signal table	RED with contact opened		ON waiting for RESTART
	FLASHES if no INPUT or OUTPUT requested by the configuration				GREEN with contact closed		FLASHES External contactors feedback error
	ON if INPUT or OUTPUT requested by the configuration						

Table 44 - Dynamic screen

MOR4S8 (Figure 22)



Figure 22 - MOR4S8

MEANING	LED							
	RUN	IN FAIL	EXT FAIL	SELO/1	RELAY 1/4		CLEAR1/4	STATUS1/8
	GREEN	RED	RED	ORANGE	RED	GREEN	YELLOW	YELLOW
Power on - initial TEST	ON	ON	ON	ON	Red		ON	ON

Table 45 - Opening screen

MEANING	LED							
	RUN	IN FAIL	EXT FAIL	SELO/1	RELAY 1/4		CLEAR1/4	STATUS1/8
	GREEN	RED	RED	ORANGE	RED	GREEN	YELLOW	YELLOW
NORMAL OPERATION	OFF if the unit is waiting for the first communication from the MASTER	OFF operation OK	OFF operation OK	Shows the NODE_SELO/1 signal table	RED with contact opened		ON waiting for RESTART	OUTPUT condition
	FLASHES if no INPUT or OUTPUT requested by the configuration				GREEN with contact closed		FLASHES wrong feedback external contactors	
	ON if INPUT or OUTPUT requested by the configuration							

Table 46 - Dynamic screen

MOS8 (Figure 23)



Figure 23 - MOS8

LED					
MEANING	RUN	IN FAIL	EXT FAIL	SELO/1	STATUS1/8
	GREEN	RED	RED	ORANGE	YELLOW
Power on - initial TEST	ON	ON	ON	ON	ON

Table 47 - Opening screen

LED					
MEANING	RUN	IN FAIL	EXT FAIL	SELO/1	STATUS1/8
	GREEN	RED	RED	ORANGE	YELLOW
NORMAL OPERATION	<p><b>OFF</b> if the unit is waiting for the first communication from the MASTER</p> <p><b>FLASHES</b> if no INPUT or OUTPUT requested by the configuration</p> <p><b>ON</b> if INPUT or OUTPUT requested by the configuration</p>	<p><b>OFF</b> operation OK</p>	<p><b>OFF</b> operation OK</p>	<p>Shows the NODE_SELO/1 signal table</p>	<p>OUTPUT condition</p>

Table 48 - Dynamic screen

MOS16 (Figure 24)



Figure 24 - MOS16

LED					
MEANING	RUN	IN FAIL	EXT FAIL	SEL0/1	STATUS1/16
	GREEN	RED	RED	ORANGE	YELLOW
Power on - initial TEST	ON	ON	ON	ON	ON

Table 49 - Opening screen

LED					
MEANING	RUN	IN FAIL	EXT FAIL	SEL 0/1	STATUS1/16
	GREEN	RED	RED	ORANGE	YELLOW
<b>NORMAL OPERATION</b>	<p><b>OFF</b> if the unit is waiting for the first communication from the MASTER</p> <p><b>FLASHES</b> if no INPUT or OUTPUT requested by the configuration</p> <p><b>ON</b> if INPUT or OUTPUT requested by the configuration</p>	<b>OFF</b> operation OK	<b>OFF</b> operation OK	Shows the NODE_SEL0/1 signal table	OUTPUT condition

Table 50 - Dynamic screen

MV1, MV2 (Figure 25)

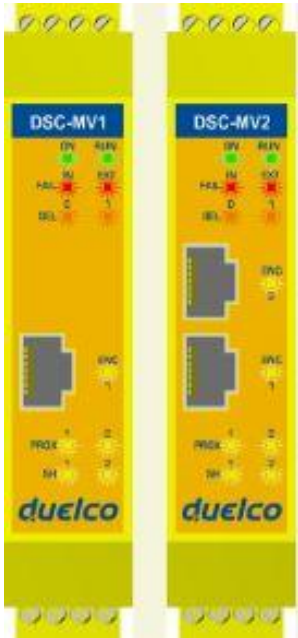

Figure 25 - MV1, MV2

MEANING	LED						
	RUN	IN FAIL	EXT FAIL	SEL0/1	ENC*	PROX	SH
	GREEN	RED	RED	ORANGE	YELLOW	YELLOW	YELLOW
Power on - initial TEST	ON	ON	ON	ON	ON	ON	ON

Table 51 - Opening screen

MEANING	LED						
	RUN	IN FAIL	EXT FAIL	SEL0/1	ENC*	PROX	SH
	GREEN	RED	RED	ORANGE	YELLOW	YELLOW	YELLOW
NORMAL OPERATION	OFF if the unit is waiting for the first communication from the MASTER						OFF Axis in normal speed range
	FLASHES if no INPUT or OUTPUT requested by the configuration	OFF operation OK	OFF operation OK	Shows the NODE_SEL0/1 signal table	ON Encoder connected and operative	ON Proximity connected and operative	ON Axis in stand still
	ON if INPUT or OUTPUT requested by the configuration						BLINKING Axis in overspeed

Table 52 - Dynamic screen

\* NOT PRESENT ON MV0 MODULE

MR2 (Figure 26) / MR4 (Figure 27)



Figure 26 - MR2

Figure 27 - MR4

MEANING	LED
	OSSD1 GREEN
NORMAL OPERATION	ON with output activated

Table 53 - MR2 - Dynamic screen

MEANING	LED	
	OSSD1 GREEN	OSSD2 GREEN
NORMAL OPERATION	ON with output activated	

Table 54 - MR4 - Dynamic screen

MO4LHCS8 (Figure 28)



Figure 28 - MO4LHCS8

MEANING	LED							
	RUN	IN FAIL	EXT FAIL	SELO/1	OSSD 1/4		CLEAR 1/4	STATUS 1/8
	GREEN	RED	RED	ORANGE	RED	GREEN	YELLOW	YELLOW
Power on - initial TEST	ON	ON	ON	ON	Red		ON	ON

Table 55 - Opening screen

MEANING	LED							
	RUN	IN FAIL	EXT FAIL	SELO/1	OSSD 1/4		CLEAR 1/4	STATUS 1/8
	GREEN	RED	RED	ORANGE	RED	GREEN	YELLOW	YELLOW
NORMAL OPERATION	OFF if the unit is waiting for the first communication from the MASTER	OFF operation OK	OFF operation OK	Shows the NODE_SELO/1 signal table	RED with output OFF		ON waiting for RESTART	ON The associated SYSTEM STATUS output is active
	FLASHES if no INPUT or OUTPUT requested by the configuration				GREEN with output ON		FLASHES wrong feedback external contactors	OFF The associated SYSTEM STATUS output is NOT active
	ON if INPUT or OUTPUT requested by the configuration							

Table 56 - Dynamic screen



MA4 (Figure 29)



Figure 29 - MA4

MEANING	LED				
	RUN GREEN	IN FAIL RED	EXT FAIL RED	SELO/1 ORANGE	CHAN 1/4 RED/GREEN
Power on - initial TEST	ON	ON	ON	ON	RED ON

Table 57 - Initial operation LEDs state

MEANING	LED					
	RUN	IN FAIL	EXT FAIL	SELO/1	CHAN 1/4	
	GREEN	RED	RED	ORANGE	RED	GRN
NORMAL OPERATION	OFF if the unit is waiting for the first communication from the MASTER	OFF	OFF Normal operation  ON Anomaly detected on measurement channel	Shows the NODE_SELO/1 signal table	Channel configured	
	FLASHES if no INPUT configuration is requested from MASTER				OFF	ON
	ON if INPUT configuration is requested from MASTER				Channel NOT configured	
					OFF	OFF

Table 58 - Dynamic operation LEDs state

**TROUBLESHOOTING**

Master M1 (Figure 30)

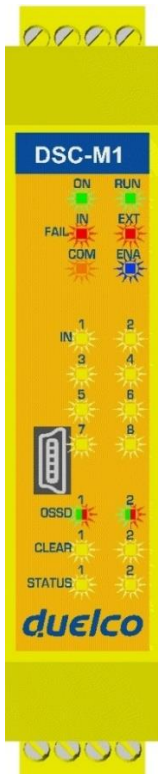

MEANING	LED									REMEDY
	RUN GREEN	IN FAIL RED	EXT FAIL RED	COM ORANGE	IN1÷8 YELLOW	ENA BLUE	OSSD1/2 RED/GREEN	CLEAR1/2 YELLOW	STATUS1/2 YELLOW	
Internal fat	OFF	2 or 3 flashes	OFF	OFF	OFF	OFF	Red	OFF	OFF	Return the unit to Duelco to be repaired
OSSD output error	OFF	4 flashes	OFF	OFF	OFF	OFF	4 flashes (only the LED corresponding to the output in FAIL mode)	OFF	OFF	<ul style="list-style-type: none"> <li>• Check the OSSD1/2 connections</li> <li>• If the problem persists return the M1 to Duelco to be repaired</li> </ul>
Error in communication with slave	OFF	5 flashes	OFF	OFF	OFF	OFF	OFF	OFF	OFF	<ul style="list-style-type: none"> <li>• Restart the system.</li> <li>• If the problem persists return the M1 to Duelco to be repaired</li> </ul>
Slave unit error	OFF	ON	OFF	OFF	OFF	OFF	OFF	OFF	OFF	<ul style="list-style-type: none"> <li>• Restart the system</li> <li>• Check which unit is in FAIL mode</li> </ul>
DSC-MCM error	OFF	6 flashes	OFF	6 flashes	OFF	OFF	OFF	OFF	OFF	Replace the DSC-MCM

Table 59 - Troubleshooting M1

Figure 30 - M1

Master M1S (Figure 31)



Figure 31 - M1S

MEANING	LED								REMEDY
	RUN GREEN	IN FAIL RED	EXT FAIL RED	COM ORANGE	IN1÷8 YELLOW	ENA BLUE	OSSD1/4 RED/GREEN/YELLOW	STATUS1/4 YELLOW	
Internal fault	OFF	2 or 3 flashes	OFF	OFF	OFF	OFF	Red	OFF	Return the unit to Duelco to be repaired
OSSD output error	OFF	4 flashes	OFF	OFF	OFF	OFF	4 flashes (only the LED corresponding to the output in FAIL mode)	OFF	<ul style="list-style-type: none"> <li>Check the OSSD1/2 connections</li> <li>If the problem persists return the M1 to Duelco to be repaired</li> </ul>
Error in communication with slave	OFF	5 flashes	OFF	OFF	OFF	OFF	OFF	OFF	<ul style="list-style-type: none"> <li>Restart the system.</li> <li>If the problem persists return the M1 to Duelco to be repaired</li> </ul>
Slave unit error	OFF	ON	OFF	OFF	OFF	OFF	OFF	OFF	<ul style="list-style-type: none"> <li>Restart the system</li> <li>Check which unit is in FAIL mode</li> </ul>
DSC-MCM error	OFF	6 flashes	OFF	6 flashes	OFF	OFF	OFF	OFF	Replace the DSC-MCM
Overload on OSSD / OSSD load connected to 24V	ON	OFF	ON	OFF	Inputs State	ON	Red blinking (only LED corresponding to the relative output)	OUTPUT state	Verify OSSD connections
Short circuit or overload detected on status output	ON	OFF	ON	OFF	Inputs State	ON	OUTPUT state	blinking	Verify output status connections

Table 60 - Troubleshooting M1S

MI802 (Figure 32)

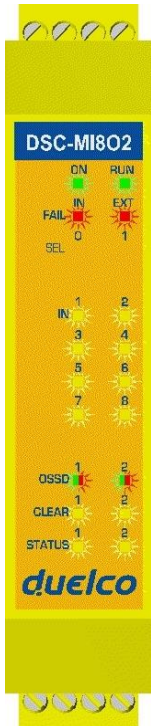

Figure 32 - MI802

MEANING	LED								REMEDY
	RUN	IN FAIL	EXT FAIL	SEL0/1	IN1÷8	OSSD1/2	CLEAR1/2	STATUS1/2	
	GREEN	RED	RED	ORANGE	YELLOW	RED/GREEN	YELLOW	YELLOW	
Internal fault	OFF	2 or 3 flashes	OFF	Shows the physical address of the unit	OFF	Red	OFF	OFF	<ul style="list-style-type: none"> <li>Return the unit to Duelco to be repaired</li> </ul>
Compatibility error	OFF	5 flashes	OFF		5 flashes	5 flashes	5 flashes	5 flashes	<ul style="list-style-type: none"> <li>Firmware version not compatible with M1, return to Duelco for FW upgrade.</li> </ul>
OSSD output error	OFF	4 flashes	OFF		4 flashes (only the LED corresponding to the output in FAIL mode)	OFF	OFF	OFF	<ul style="list-style-type: none"> <li>Check OSSD1/2 connections</li> <li>If the problem persists, return the unit to Duelco to be repaired</li> </ul>
Error in communication with master	OFF	5 flashes	OFF		OFF	OFF	OFF	OFF	<ul style="list-style-type: none"> <li>Restart the system</li> <li>If the problem persists, return the MI802 to Duelco to be repaired</li> </ul>
Error on other slave or M1	OFF	ON	OFF		OFF	OFF	OFF	OFF	<ul style="list-style-type: none"> <li>Restart the system</li> <li>Check which unit is in FAIL mode</li> </ul>
Same type of slave with same address detected	OFF	5 flashes	5 flashes		OFF	OFF	OFF	OFF	<ul style="list-style-type: none"> <li>Change the unit's address (see <b>NODE SEL</b>)</li> </ul>
Node detection circuit error	OFF	3 flashes	OFF		3 flashes	OFF	OFF	OFF	OFF

Table 61 - Troubleshooting MI802

MI804 (Figure 33)

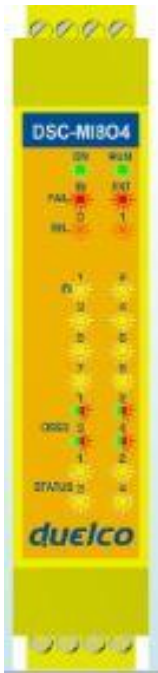

Figure 33 - MI804

MEANING	LED							REMEDY
	RUN	IN FAIL	EXT FAIL	SEL0/1	IN1÷8	OSSD1/4	STATUS1/4	
	GREEN	RED	RED	ORANGE	YELLOW	RED/GREEN/YELLOW	YELLOW	
Internal fault	OFF	2 or 3 flashes	OFF	Shows the physical address of the unit	OFF	Red	OFF	• Return the unit to Duelco to be repaired
Compatibility error	OFF	5 flashes	OFF		5 flashes	5 flashes	5 flashes	• Firmware version not compatible with M1, return to Duelco for FW upgrade.
OSSD output error	OFF	4 flashes	OFF		OFF	4 flashes (only the LED corresponding to the output in FAIL mode)	OFF	• Check OSSD1/2 connections • If the problem persists, return the unit to Duelco to be repaired
Error in communication with master	OFF	5 flashes	OFF		OFF	OFF	OFF	• Restart the system • If the problem persists, return the MI804 to Duelco to be repaired
Error on other slave or M1	OFF	ON	OFF		OFF	OFF	OFF	• Restart the system • Check which unit is in FAIL mode
Same type of slave with same address detected	OFF	5 flashes	5 flashes		OFF	OFF	OFF	• Change the unit's address (see <b>NODE SEL</b> )
Overload on OSSD / OSSD load connected to 24V	ON	OFF	ON	Shows the physical address of the unit	Inputs State	Red blinking (only LED corresponding to the relative output)	OUTPUT state	• Verify OSSD connections
Short circuit or overload detected on status output	ON	OFF	ON	Shows the physical address of the unit	Inputs State	OUTPUT state	blinking	• Verify output status connections

Table 62 - Troubleshooting MI804

MI8 (Figure 34)

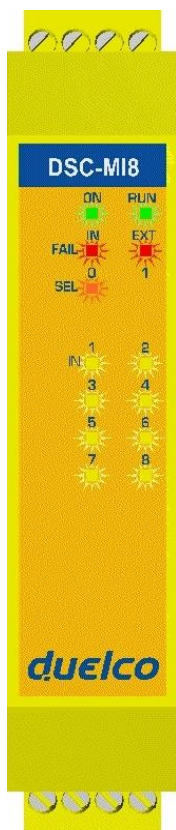

Figure 34 - MI8

MEANING	LED					REMEDY
	RUN GREEN	IN FAIL RED	EXT FAIL RED	SEL0/1 ORANGE	IN1÷8 YELLOW	
Internal fault	OFF	2 or 3 flashes	OFF	Shows the physical address of the unit	OFF	• Return the unit to Duelco to be repaired
Compatibility error	OFF	5 flashes	OFF		5 flashes	• Firmware version not compatible with M1, return to Duelco for FW upgrade.
Error in communication with master	OFF	5 flashes	OFF		OFF	• Restart the system • If the problem persists, return the unit to Duelco to be repaired
Error on other slave or M1	OFF	ON	OFF		OFF	• Restart the system • Check which unit is in FAIL mode
Same type of slave with same address detected	OFF	5 flashes	5 flashes		OFF	• Change the unit's address (see <b>NODE SEL</b> )
Node detection circuit error	OFF	3 flashes	OFF		3 flashes	OFF

Table 63 - Troubleshooting MI8

MI12T8 (Figure 35)

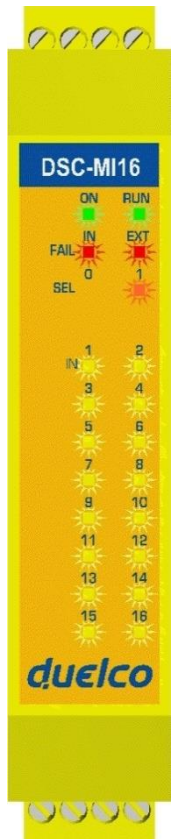

Figure 35 - MI12T8

LED						
MEANING	RUN	IN FAIL	EXT FAIL	SEL0/1	IN1÷12	REMEDY
	GREEN	RED	RED	ORANGE	YELLOW	
Internal fault	OFF	2 or 3 flashes	OFF	Shows the physical address of the unit	OFF	Return the unit to Duelco to be repaired
Compatibility error	OFF	5 flashes	OFF		5 flashes	<ul style="list-style-type: none"> <li>Firmware version not compatible with M1, return to Duelco for FW upgrade.</li> </ul>
Error in communication with master	OFF	5 flashes	OFF		OFF	<ul style="list-style-type: none"> <li>Restart the system</li> <li>If the problem persists, return the unit to Duelco to be repaired</li> </ul>
Error on other slave or M1	OFF	ON	OFF		OFF	<ul style="list-style-type: none"> <li>Restart the system</li> <li>Check which unit is in FAIL mode</li> </ul>
Same type of slave with same address detected	OFF	5 flashes	5 flashes		OFF	<ul style="list-style-type: none"> <li>Change the unit's address (see <b>NODE SEL</b>)</li> </ul>
Node detection circuit error	OFF	3 flashes	OFF		3 flashes	OFF

Table 64 - Troubleshooting MI12T8

MI16 (Figure 36)



MEANING	LED					REMEDY
	RUN	IN FAIL	EXT FAIL	SEL0/1	IN1÷16	
	GREEN	RED	RED	ORANGE	YELLOW	
Internal fault	OFF	2 or 3 flashes	OFF	Shows the physical address of the unit	OFF	• Return the unit to Duelco to be repaired
Compatibility error	OFF	5 flashes	OFF		5 flashes	• Firmware version not compatible with M1, return to Duelco for FW upgrade.
Error in communication with master	OFF	5 flashes	OFF		OFF	• Restart the system • If the problem persists, return the unit to Duelco to be repaired
Error on other slave or M1	OFF	ON	OFF		OFF	• Restart the system • Check which unit is in FAIL mode
Same type of slave with same address detected	OFF	5 flashes	5 flashes		OFF	• Change the unit's address (see <b>NODE SEL</b> )
Node detection circuit error	OFF	3 flashes	OFF		3 flashes	OFF

Table 65 - Troubleshooting MI16

Figure 36 - MI16



MO2 / MO4 (Figure 37)

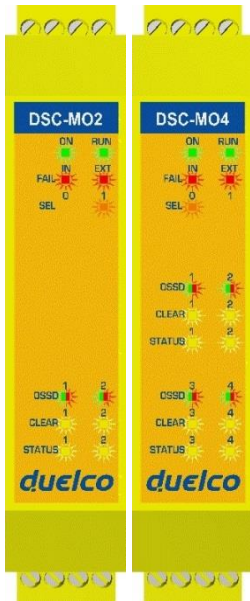

Figure 37 - MO2 / MO4

MEANING	LED							REMEDY
	RUN	IN FAIL	EXT FAIL	SELO/1	OSSD1/4	CLEAR1/4	STATUS1/4	
	GREEN	RED	RED	ORANGE	RED/GREEN	YELLOW	YELLOW	
Internal fault	OFF	2 or 3 flashes	OFF	Shows the physical address of the unit	Red	OFF	OFF	Return the unit to Duelco to be repaired
Compatibility error	OFF	5 flashes	OFF		5 flashes	5 flashes	5 flashes	<ul style="list-style-type: none"> <li>Firmware version not compatible with M1, return to Duelco for FW upgrade.</li> </ul>
OSSD output error	OFF	4 flashes	OFF		4 flashes (only the LED corresponding to the output in FAIL mode)	OFF	OFF	<ul style="list-style-type: none"> <li>Check OSSD1/2 connections</li> <li>If the problem persists, return the unit to Duelco to be repaired</li> </ul>
Error in communication with master	OFF	5 flashes	OFF		OFF	OFF	OFF	<ul style="list-style-type: none"> <li>Restart the system</li> <li>If the problem persists, return the unit to Duelco to be repaired</li> </ul>
Error on other slave or M1	OFF	ON	OFF		OFF	OFF	OFF	<ul style="list-style-type: none"> <li>Restart the system</li> <li>Check which unit is in FAIL mode</li> </ul>
Same type of slave with same address detected	OFF	5 flashes	5 flashes		OFF	OFF	OFF	<ul style="list-style-type: none"> <li>Change the unit's address (see <b>NODE SEL</b>)</li> </ul>
Power supply missing on OSSD 3,4 (MO4 only)	ON	OFF	ON		Red flashes	flashes	OUTPUT condition	<ul style="list-style-type: none"> <li>Connect 13 and 14 pin to power supply</li> </ul>
Status output overload or short circuit	OFF	OFF	ON		OUTPUT condition	CLEAR condition	flashes	<ul style="list-style-type: none"> <li>Check STATUS connections</li> </ul>
Error on node detection circuit	OFF	3 flashes	OFF		3 flashes	OFF	OFF	OFF

Table 66 - Troubleshooting MO2/MO4

MO4L (Figure 38)

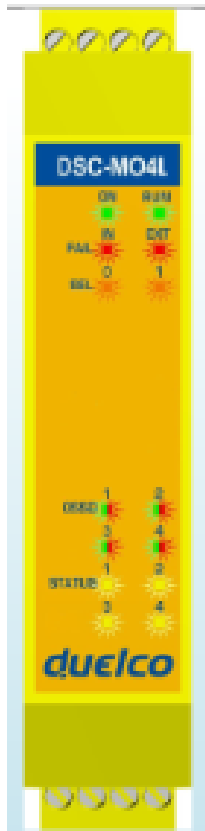

Figure 38 - MO4L

MEANING	LED						REMEDY
	RUN	IN FAIL	EXT FAIL	SEL0/1	OSSD1/4	STATUS1/4	
	GREEN	RED	RED	ORANGE	RED/GREEN/YELLOW	YELLOW	
Internal fault	OFF	2 or 3 flashes	OFF	Shows the physical address of the unit	Red	OFF	• Return the unit to Duelco to be repaired
Compatibility error	OFF	5 flashes	OFF		5 flashes	5 flashes	• Firmware version not compatible with M1, return to Duelco for FW upgrade.
OSSD output error	OFF	4 flashes	OFF		4 flashes (only the LED corresponding to the output in FAIL mode)	OFF	• Check OSSD1/2 connections • If the problem persists, return the unit to Duelco to be repaired
Error in communication with master	OFF	5 flashes	OFF		OFF	OFF	• Restart the system • If the problem persists, return the MO4L to Duelco to be repaired
Error on other slave or M1	OFF	ON	OFF		OFF	OFF	• Restart the system • Check which unit is in FAIL mode
Same type of slave with same address detected	OFF	5 flashes	5 flashes		OFF	OFF	• Change the unit's address (see <b>NODE SEL</b> )
Overload on OSSD / OSSD load connected to 24V	ON	OFF	ON	Shows the physical address of the unit	Red blinking (only LED corresponding to the relative output)	OUTPUT state	• Verify OSSD connections
Short circuit or overload detected on status output	ON	OFF	ON	Shows the physical address of the unit	OUTPUT state	blinking	• Verify output status connections

Table 67 - Troubleshooting MO4L

MOR4 (Figure 39)



Figure 39 - MOR4

MEANING	LED							REMEDY
	RUN GREEN	IN FAIL RED	EXT FAIL RED	SEL 0/1 ORANGE	RELAY 1/4		CLEAR1/4 YELLOW	
Internal fault	OFF	2 / 3 flashes	OFF	Shows the physical address of the unit	Rosso		OFF	<ul style="list-style-type: none"> <li>Return the unit to Duelco to be repaired</li> </ul>
Compatibility error	OFF	5 flashes	OFF		5 flashes		5 flashes	<ul style="list-style-type: none"> <li>Firmware version not compatible with M1, return to Duelco for FW upgrade.</li> </ul>
Relais output error	OFF	4 flashes	OFF		4 flashes (only the LED corresponding to the output in FAIL mode)		OFF	<ul style="list-style-type: none"> <li>If the problem persists, return the module to Duelco to be repaired</li> </ul>
Error in communication with master	OFF	5 flashes	OFF		OFF		OFF	<ul style="list-style-type: none"> <li>Restart the system</li> <li>If the problem persists, return the module to Duelco to be repaired</li> </ul>
Error on other slave or M1	OFF	ON	OFF		OFF		OFF	<ul style="list-style-type: none"> <li>Restart the system</li> <li>Check which unit is in FAIL mode</li> </ul>
Same type of slave with same address detected	OFF	5 flashes	5 flashes		OFF		OFF	<ul style="list-style-type: none"> <li>Change the unit's address (see <b>NODE SEL</b>)</li> </ul>
External contactors feedback error on Category 4 relay	ON	OFF	4 flashes		4 flashes (only the LEDs corresponding to the outputs in FAIL mode)			<ul style="list-style-type: none"> <li>Verify connections 5,6,7,8.</li> </ul>
Error on node detection circuit	OFF	3 flashes	OFF		3 flashes	OFF	OFF	<ul style="list-style-type: none"> <li>Return the module to Duelco to be repaired</li> </ul>

Table 68 - Troubleshooting MOR4

MOR4S8 (Figure 40)

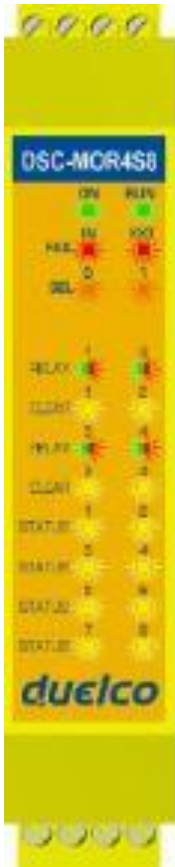

Figure 40 - MOR4S8

MEANING	LED								REMEDY	
	RUN GREEN	IN FAIL RED	EXT FAIL RED	SEL0/1 ORANGE	RELAY 1/4		CLEAR1/4 YELLOW	STATUS1/8 YELLOW		
Internal fault	OFF	2 / 3 flashes	OFF	Shows the physical address of the unit	Rosso		OFF		• Return the unit to Duelco to be repaired	
Compatibility error	OFF	5 flashes	OFF		5 flashes		5 flashes	5 flashes	• Firmware version not compatible with M1, return to Duelco for FW upgrade.	
Relais output error	OFF	4 flashes	OFF		4 flashes (only the LED corresponding to the output in FAIL mode)		OFF	OFF	• If the problem persists, return the module to Duelco to be repaired	
Error in communication with master	OFF	5 flashes	OFF		OFF		OFF	OFF	• Restart the system • If the problem persists, return the module to Duelco to be repaired	
Error on other slave or M1	OFF	ON	OFF		OFF		OFF	OFF	• Restart the system • Check which unit is in FAIL mode	
Same type of slave with same address detected	OFF	5 flashes	5 flashes		OFF		OFF	OFF	• Change the unit's address (see <b>NODE SEL</b> )	
External contactors feedback error on Category 4 relay	ON	OFF	4 flashes		4 flashes (only the LEDs corresponding to the outputs in FAIL mode)			OFF	• Verify connections 5,6,7,8.	
Error on node detection circuit	OFF	3 flashes	OFF		3 flashes	OFF		OFF	OFF	• Return the module to Duelco to be repaired
Short circuit or overload detected on status output	OFF	OFF	ON		OFF	OUTPUT condition		CLEAR condition	flash	• Verify output status connections

Table 69 - Troubleshooting MOR4S8

English

MOS8 (Figure 41)



Figure 41 – MOS8

MEANING	LED					REMEDY
	RUN	IN FAIL	EXT FAIL	SEL0/1	STATUS1/8	
	GREEN	RED	RED	ORANGE	YELLOW	
Internal fault	OFF	2 / 3 flashes	OFF	Shows the physical address of the unit	OFF	<ul style="list-style-type: none"> <li>Return the unit to Duelco to be repaired</li> </ul>
Compatibility error	OFF	5 flashes	OFF		5 flashes	<ul style="list-style-type: none"> <li>Firmware version not compatible with M1, return to Duelco for FW upgrade.</li> </ul>
Error in communication with master	OFF	5 flashes	OFF		OFF	<ul style="list-style-type: none"> <li>Restart the system</li> <li>If the problem persists, return the module to Duelco to be repaired</li> </ul>
Error on other slave or M1	OFF	ON	OFF		OFF	<ul style="list-style-type: none"> <li>Restart the system</li> <li>Check which unit is in FAIL mode</li> </ul>
Same type of slave with same address detected	OFF	5 flashes	5 flashes		OFF	<ul style="list-style-type: none"> <li>Change the unit's address (see <b>NODE SEL</b>)</li> </ul>
Error on node detection circuit	OFF	3 flashes	OFF	3 flashes	OFF	<ul style="list-style-type: none"> <li>Return the module to Duelco to be repaired</li> </ul>
Short circuit or overload detected on status 1-8 output	OFF	OFF	ON	OFF	flash	<ul style="list-style-type: none"> <li>Verify output status 1-8 connections</li> </ul>
Power supply missing on status 1-8 output	OFF	OFF	ON	OFF	flash alternatively	<ul style="list-style-type: none"> <li>Connect 5 pin to power supply</li> </ul>

Table 70 - Troubleshooting MOS8

MOS16 (Figure 42)



Figure 42 - MOS16

MEANING	LED						REMEDY
	RUN	IN FAIL	EXT FAIL	SELO/1	STATUS1/8	STATUS9/16	
	GREEN	RED	RED	ORANGE	YELLOW	YELLOW	
Internal fault	OFF	2 / 3 flashes	OFF	Shows the physical address of the unit	OFF	OFF	<ul style="list-style-type: none"> <li>Return the unit to Duelco to be repaired</li> </ul>
Compatibility error	OFF	5 flashes	OFF		5 flashes	5 flashes	<ul style="list-style-type: none"> <li>Firmware version not compatible with M1, return to Duelco for FW upgrade.</li> </ul>
Error in communication with master	OFF	5 flashes	OFF		OFF	OFF	<ul style="list-style-type: none"> <li>Restart the system</li> <li>If the problem persists, return the module to Duelco to be repaired</li> </ul>
Error on other slave or M1	OFF	ON	OFF		OFF	OFF	<ul style="list-style-type: none"> <li>Restart the system</li> <li>Check which unit is in FAIL mode</li> </ul>
Same type of slave with same address detected	OFF	5 flashes	5 flashes		OFF	OFF	<ul style="list-style-type: none"> <li>Change the unit's address (see <b>NODE SEL</b>)</li> </ul>
Error on node detection circuit	OFF	3 flashes	OFF		3 flashes	OFF	OFF
Short circuit or overload detected on status 1-8 output	OFF	OFF	ON	OFF	flash	OFF	<ul style="list-style-type: none"> <li>Verify output status 1-8 connections</li> </ul>
Short circuit or overload detected on status 9-16 output	OFF	OFF	ON	OFF	OFF	flash	<ul style="list-style-type: none"> <li>Verify output status 9-16 connections</li> </ul>
Power supply missing on status 1-8 output	OFF	OFF	ON	OFF	flash alternatively	OFF	<ul style="list-style-type: none"> <li>Connect 5 pin to power supply</li> </ul>
Power supply missing on status 9-16 output	OFF	OFF	ON	OFF	OFF	flash alternatively	<ul style="list-style-type: none"> <li>Connect 6 pin to power supply</li> </ul>

Table 71 - Troubleshooting MOS16

MV0, MV1, MV2 (Figure 43)

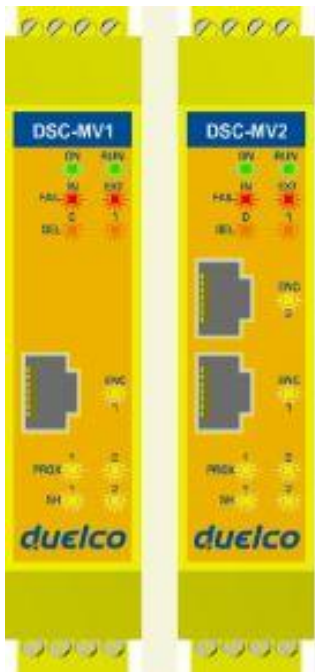

Figure 43 - MV1, MV2

MEANING	LED							REMEDY
	RUN	IN FAIL	EXT FAIL	SELO/1	ENC*	PROX	SH	
	GREEN	RED	RED	ORANGE	YELLOW	YELLOW	YELLOW	
Internal fault	OFF	2 or 3 flashes	OFF	Shows the physical address of the unit	OFF	OFF	OFF	• Return the unit to Duelco to be repaired
Compatibility error	OFF	5 flashes	OFF		5 flashes	5 flashes	5 flashes	• Firmware version not compatible with M1, return to Duelco for FW upgrade.
Encoder INTERNAL error	OFF	3 flashes	OFF		3 flashes	OFF	OFF	• Change the encoder • Return the unit to Duelco to be repaired
Proximity INTERNAL error		3 flashes	OFF			3 flashes		• Change the proximity • Return the unit to Duelco to be repaired
Error on node detection circuit	OFF	3 flashes	OFF	3 flashes	OFF	OFF	OFF	• Return the unit to Duelco to be repaired
Same type of slave with same address detected	OFF	5 flashes	5 flashes		OFF	OFF	OFF	• Change the unit's address (see <b>NODE SEL</b> )
Encoder not connected but requested from the configuration	OFF	OFF	3 flashes **		3 flashes **	OFF	OFF	• Verify encoder connection and power supply • Verify input frequency (in range)
Proximity not connected but requested from the configuration	OFF	OFF	3 flashes **		OFF	3 flashes **	OFF	• Verify proximity connection • Verify input frequency (in range)

Table 72 - Troubleshooting MV1/MV2

\* NOT PRESENT ON MV0 MODULE

\*\* WITH FAULT OF A SINGLE CHANNEL, THE SIGNAL IS PRESENTED IN TWO TEMPORAL WINDOWS: IN THE FIRST IS SHOWED TE FAULT, IN THE SECOND IS SHOWED THE CORRECT CHANNEL.

MO4LHCS8 (Figure 44)



Figure 44 - MO4LHCS8

MEANING	LED							REMEDY	
	RUN GREEN	IN FAIL RED	EXT FAIL RED	SEL 0/1 ORANGE	OSSD 1/4 RED GREEN		CLEAR1/4 YELLOW		STATUS1/8 YELLOW
Internal fault	OFF	2 / 3 flashes	OFF	Shows the physical address of the unit	Rosso		OFF		• Return the unit to Duelco to be repaired
Compatibility error	OFF	5 flashes	OFF		5 flashes		5 flashes	5 flashes	• Firmware version not compatible with M1, return to Duelco for FW upgrade.
OSSD output error	OFF	4 flashes	OFF		4 flashes (only the LED corresponding to the output in FAIL mode)		OFF	OFF	• If the problem persists, return the module to Duelco to be repaired
Error in communication with master	OFF	5 flashes	OFF		OFF		OFF	OFF	• Restart the system • If the problem persists, return the module to Duelco to be repaired
Error on other slave or M1	OFF	ON	OFF		OFF		OFF	OFF	• Restart the system • Check which unit is in FAIL mode
Same type of slave with same address detected	OFF	5 flashes	5 flashes		OFF		OFF	OFF	• Change the unit's address (see <b>NODE SEL</b> )
Short circuit or overload detected on status output	ON	OFF	ON		OUTPUT condition		CLEAR condition	flash	• Verify output status connections
OSSD overload or load connected to 24VDC	ON	OFF	ON		Blinking (only LED corresponding to the relative output)		OFF	OUTPUT condition	• Verify OSSD connections
Power supply missing on OSSD3-OSSD4	ON	OFF	ON		OSSD3/OSSD4 led blinking		OSSD3/OSSD4 led blinking	OUTPUT condition	• Connect pin 14 to 24VDC
Error on node detection circuit	OFF	3 flashes	OFF	3 flashes	OFF		OFF	OFF	• Return the module to Duelco to be repaired

Table 73 - Troubleshooting MO4LHCS8

English



MA4 (Figure 45)



Figure 45 - MA4

MEANING	LED						REMEDY
	RUN	IN FAIL	EXT FAIL	SEL0/1	CHAN 1/4		
	GREEN	RED	RED	ORANGE	RED	GREEN	
Internal fault	OFF	2 / 3 flashes	OFF	Shows the physical address of the unit	OFF	OFF	• Return the unit to Duelco to be repaired
Compatibility error	OFF	3 flashes	OFF		OFF	OFF	• Wrong MASTER firmware version, return MASTER unit to Duelco in order to update the firmware.
Communication error with MASTER	OFF	5 flashes	OFF		OFF	OFF	• Reboot the system • If reboot does not work return the unit to Duelco
Error on other slave or M1	OFF	ON	OFF		OFF	OFF	• Restart the system • Check which unit is in FAIL mode
Same type of slave with same address detected	OFF	5 flashes	5 flashes		OFF	OFF	• Change the unit address (see NODE SEL)
Wrong configuration received	OFF	5 flashes	OFF		5 flashes	OFF	• Check field bus connection.
<b>Channel configured as SINGLE or not configured at all</b>							
Sensor supply overload	ON	OFF	ON	Shows the physical address of the unit	1 flash every 600 ms	OFF	• Check sensor connections • Check sensor status
Input channel overload	ON	OFF	ON		1 flash every 600 ms	OFF	• Check sensor connections • Check sensor status
Read value over threshold	ON	OFF	ON		3 fast flashes and a pause of 600 ms	OFF	• Check sensor connections • Check sensor status • Check threshold values set with MSD software
Read value under threshold	ON	OFF	ON		3 fast flashes and a pause of 600 ms	OFF	• Check sensor connections • Check sensor status • Check threshold values set with MSD software
Disconnected sensor	ON	OFF	ON		3 fast flashes and a pause of 600 ms	OFF	• Check sensor connections • Check sensor status



MA4

**Channel configured as Redundant (Pair of sensors connected), conditions:**

1. **Sensor supply overload. Input channel overload. Read value over threshold. Read value under threshold. Disconnected sensor:**  
When one of these diagnosis is detected the RED led relative to the channel with the problem will flash. The RED led of the other channel remains ON (no flash). If one of the above diagnosis is detected at the same time on both sensors the RED led of the second channel will flash while the RED led of the first channel remains ON (no flash).
2. **Read value from sensor pair out of tolerance diagnosis:** both LEDs of channel pair will flash.

SIGNIFICATO	LED						REMEDY
	RUN	IN FAIL	EXT FAIL	SELO/1	CHAN 1/4		
	GREEN	RED	RED	ORANGE	RED	GREEN	
Sensor supply overload	ON	OFF	ON	Shows the physical address of the unit	1 flash every 600 ms	OFF	<ul style="list-style-type: none"> <li>• Check sensor connections</li> <li>• Check sensor status</li> </ul>
Input channel overload	ON	OFF	ON		1 flash every 600 ms	OFF	<ul style="list-style-type: none"> <li>• Check sensor connections</li> <li>• Check sensor status</li> </ul>
Read value over threshold	ON	OFF	ON		3 fast flashes and a pause of 600 ms	OFF	<ul style="list-style-type: none"> <li>• Check sensor connections</li> <li>• Check sensor status</li> <li>• Check threshold values set with MSD software</li> </ul>
Read value under threshold	ON	OFF	ON		3 fast flashes and a pause of 600 ms	OFF	<ul style="list-style-type: none"> <li>• Check sensor connections</li> <li>• Check sensor status</li> <li>• Check threshold values set with MSD software</li> </ul>
Disconnected sensor	ON	OFF	ON		3 fast flashes and a pause of 600 ms	OFF	<ul style="list-style-type: none"> <li>• Check sensor connections</li> <li>• Check sensor status</li> </ul>
Read value from sensor pair out of tolerance	ON	OFF	ON		1 flash every 100 ms	OFF	<ul style="list-style-type: none"> <li>• Check sensor connections</li> <li>• Check sensor status</li> <li>• Check values set with MSD software</li> </ul>

Table 74 - Troubleshooting MA4

---

---

## DSC SAFETY DESIGNER SOFTWARE

---

The "**DSC SAFETY DESIGNER**" application software can be used to configure a logic diagram of the connections between the DSC (Master + expansions) and the components of the system being developed.

The DSC and its SLAVE units will thus monitor and control the connected safety components.

The MSD uses a versatile graphic interface to establish the connections between the various components, as described below:

---

### Installing the software

---

---

#### PC HARDWARE requirements

---

- RAM: 256 MB  
(adequate to run *Windows XP SP3 + Framework 4.0*)
- Hard disk:  $\geq$  500Mbyte of free space
- USB connector: 1.1, 2.0 or 3.0
- CD-ROM drive

---

#### PC SOFTWARE requirements

---

- Windows XP with Service Pack 3 installed (or higher OS).
- Microsoft Framework 4.0 (or higher) must be installed on the PC

---

#### How to install MSD

---

- Insert the installation CD;
- Wait for the auto-run installer to request the SW setup program;
- Otherwise, run the "**SetupDesigner.exe**" file located on the root of the installation CD.

➔ When the installation procedure is complete a window is displayed asking you to close the setup program.

## Fundamentals

Once the MSD has been correctly installed it creates an icon on the desktop.

To launch the program: double-click on this icon. =>



The opening screen shown below is displayed:

Figure 46

You are now ready to create your project.

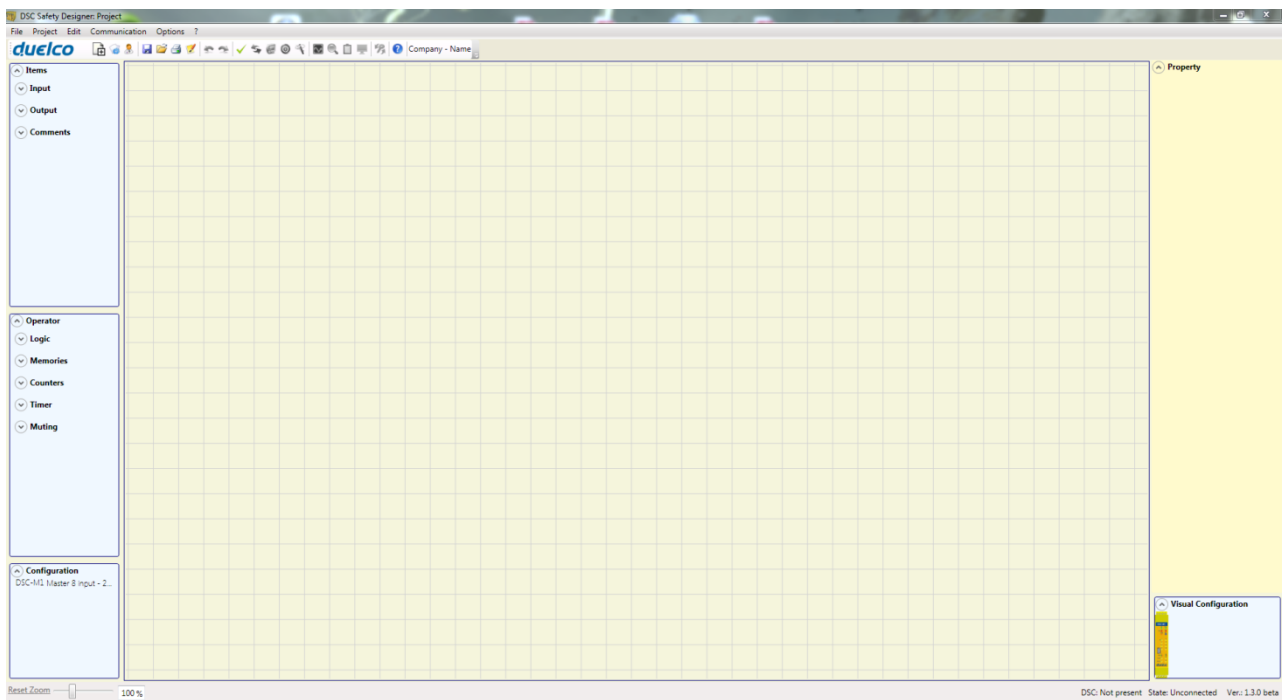

Standard tool bar

The standard tool bar is shown in Figure 47. The meanings of the icons are listed below:

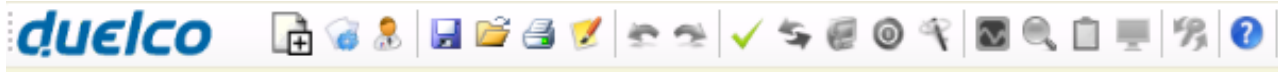





























Figure 47

- 1 ->  **CREATE A NEW PROJECT**
- 2 ->  **CHANGE CONFIGURATION** (composition of different modules)
- 3 ->  **CHANGE USER PARAMETERS** (name, company, etc)
- 4 ->  **SAVE THE ACTUAL PROJECT**
- 5 ->  **LOAD AN EXISTING PROJECT (FROM THE PC)**
- 6 ->  **PRINT THE PROJECT SCHEMATIC**
- 7 ->  **PRINT PREVIEW**
- 8 ->  **PRINTING AREA**
- 9 ->  **SNAP TO GRID**
- 10 ->  **RESOURCES ALLOCATION**
- 11 ->  **PRINT THE PROJECT REPORT**
- 12 ->  **UNDO** (CANCEL THE LAST COMMAND)
- 13 ->  **REDO** (RESTORE THE LAST CANCELLATION)
- 14 ->  **VALIDATE THE PROJECT**
- 15 ->  **CONNECT TO DSC**
- 16 ->  **SEND PROJECT TO DSC**
- 17 ->  **DISCONNECT FROM DSC**
- 18 ->  **DOWNLOAD AN EXISTING PROJECT (FROM DSC)**
- 19 ->  **MONITOR** (Real time I/O status - **graphic**)
- 20 ->  **MONITOR** (Real time I/O status - **textual**)
- 21 ->  **DOWNLOAD LOG FILE**
- 22 ->  **SHOW SYSTEM CONFIGURATION**
- 23 ->  **DOWNLOAD ERRORS LOG**
- 24 ->  **DELETE ERRORS LOG**
- 25 ->  **SCHEMATIC SIMULATION**
- 26 ->  **GRAPHIC SIMULATION**
- 27 ->  **CHANGE PASSWORD**
- 28 ->  **HELP ON-LINE**
- 29 ->  **PASSWORD RECOVERY**

## Textual tool bar

Optionally the textual tool bar shown below is also available (drop down).

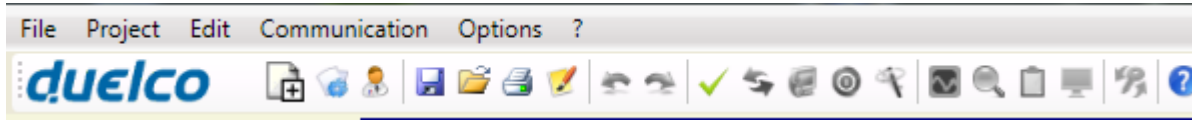

Figure 48

## Create a new project (configure the DSC system)

Select icon CREATE (Figure 47) from the standard tool bar to start a new project. The user authentication window is displayed (Figure 49).

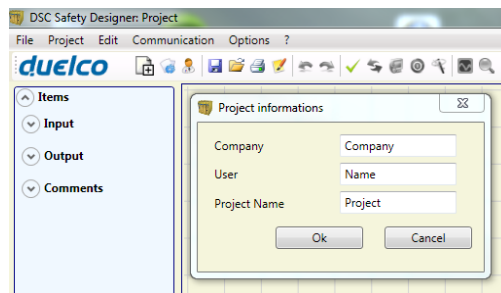

Figure 49

Next the MSD displays a window showing the M1S only. It is possible to select the M1 module acting on the drop-down menu under the master module choosing the fw version. For M1 it is <5.0, for M1S it is ≥5.0.

You may add the various units needed to create your system, using the drop-down menus at the top of the screen (select slave) and at the bottom to select the relative node (0÷3). The insertion order of modules is not important. Also the physical position of the modules must not be the same of the msd configuration menu. For example, you can physically put the slave modules to the left of the master module.

For some slave modules, it is also necessary to choose the type (MVx, MBx) by means of a second drop-down menu located below the node selection menu.

**SELECT SLAVE (to add to your configuration)**

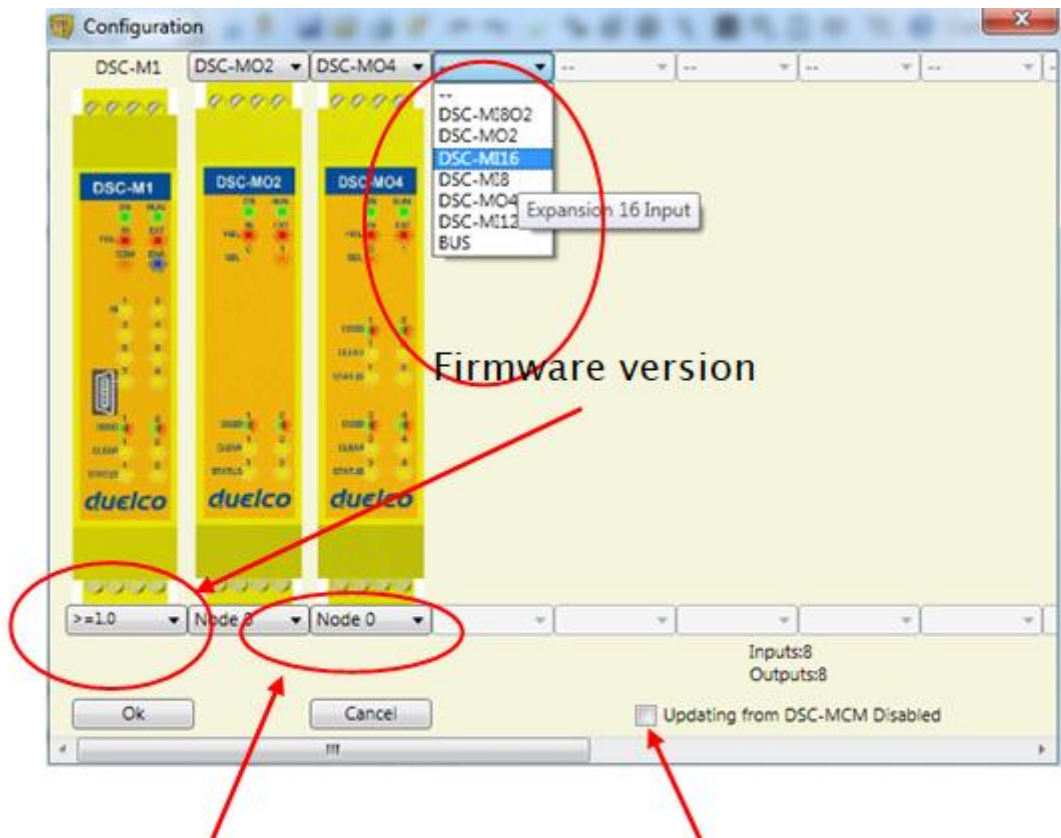

Figure 36

**SELECT NODE (from 0 to 3)**

**Select to disable DSC-MCM operations**

Figure 50

**EDIT CONFIGURATION (composition of the various modules)**

The change of the system composition is obtained with the icon .

The configuration window is showed again (Figure 47).

**Change user parameters**

The change of user parameters is obtained with the icon .

The dialog user identification request appears (Figure 51). To accomplish this operation is not necessary to Log out from DSC. Generally it serves when the-user must create a new project (even using a previously created).

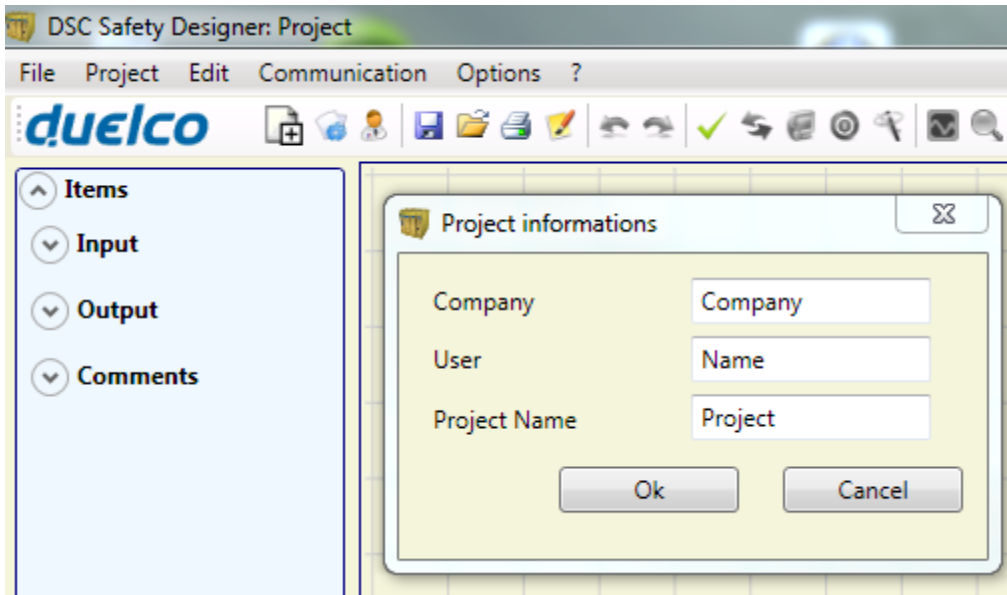

Figure 51

**OBJECTS - OPERATOR - CONFIGURATION tool bars**

Four large tool windows are displayed to the left and right of the main window (shown in Figure 52):

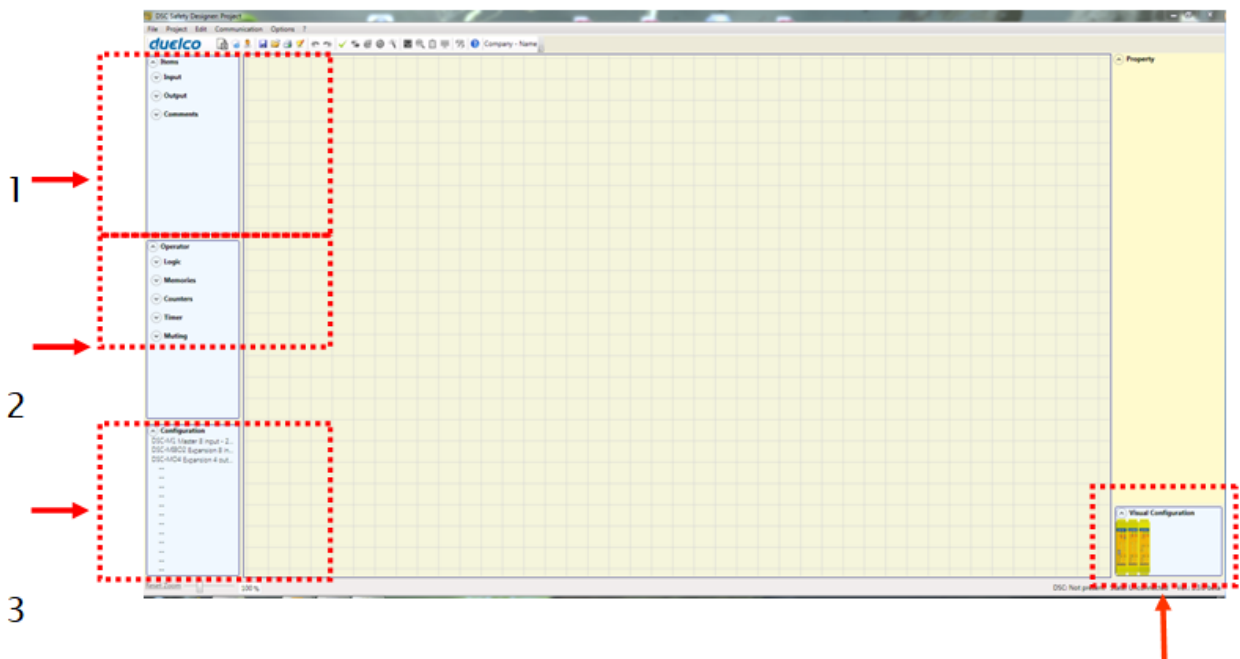

Figure 52

**1 > OBJECT TOOL WINDOW**

This contains the various function blocks that will make up your project; these blocks are divided into 4 different types:

- Inputs
- Speed Monitoring
- Outputs
- Comments

**2 > OPERATOR TOOL WINDOW**

english



This contains the various function blocks for connecting the objects in point 1; these blocks are divided into 6 different types:

- Logic
- Memories
- Safety Guard Lock
- Counters
- Timers
- Muting
- Miscellaneous

### 3 > CONFIGURATION TOOL WINDOW

This contains the description of your DSC composition.

### 4 > CONFIGURATION TOOL WINDOW (view)

This contains the graphic representation of your DSC composition.

In this window it is possible to navigate through the I/Os of each module by acting with the right mouse button on the module to be analyzed.

## Creating the diagram

Once you have selected your system composition, you are ready to configure the project.

The logic diagram is created using a **DRAG&DROP** function:

- Select the objects as required from the windows described previously (each single object is described in detail in the following sections) and drag it into the design area.
- Now when you select the object the **PROPERTIES** window is enabled, where you must fill in the fields as required.
- When you need to set a specific numerical value with a slide (eg filter) use the left and right arrows on your keyboard or click the sides of the slider of the slide.
- Connect the objects by moving the mouse over the required pin and then dragging it onto the pin to be connected.
- If the scheme requires the PAN function (moving working area in the window), select the object to move and use the arrow keys on your keyboard.
- If the scheme is very complicated and requires a connection between two elements very far, use the "Interpage" component. The element "*Interpage out*" must have a name which, invoked by the corresponding "*Interpage in*", allows the desired link.

(scheme side SX)

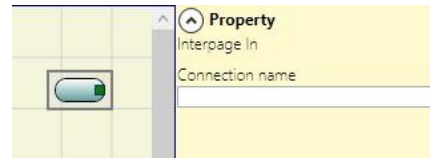
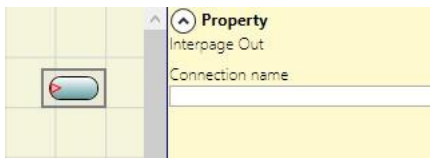

(scheme side SX)

- When you need to duplicate an object, select it and press CTRL+C / CTRL+V keys on your keyboard.
- When you need to delete an object or a link, select it and press DEL key on your keyboard.

## Use of mouse right button

### ON BLOCK INPUT / OUTPUT

- Copy / Paste
- Delete
- Delete all the assigned pins
- Alignment with other functional blocks (multiple selection)
- On-line Help
- Monitor Mode: Show / Hide Properties window
- The block Status: pin input enable / disable logical negation

### ON BLOCK OPERATORS

- Copy / Paste
- Delete
- Alignment with other functional blocks (multiple selection)

- On-line Help
- On input pin: activate / deactivate logical negation
- Monitor Mode: Show / Hide Properties window

ON TERMINALS

- Alignment with other blocks

ON CONNECTION (WIRES)

- Delete
- Display full path of the connection (network)

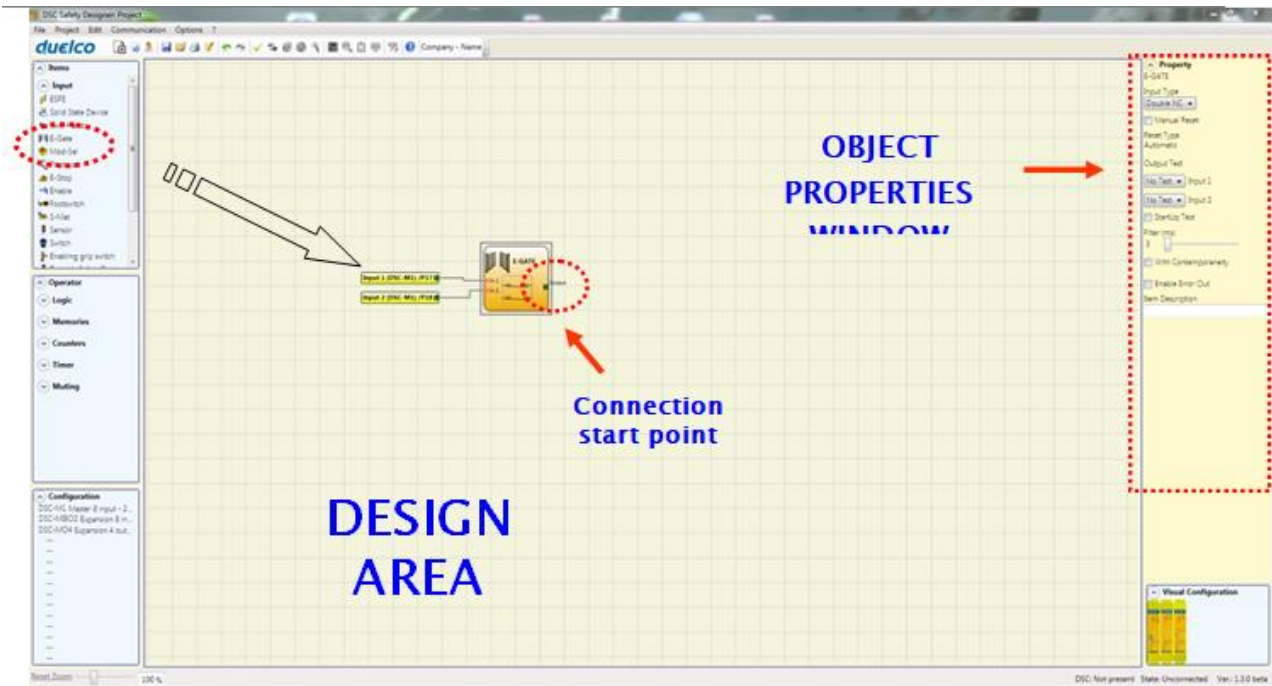

Figure 53

## Example of a project

Figure 54 shows an example of a project in which the M1S unit only is connected to two safety blocks (E-GATE and E-STOP).

The M1S inputs (1,2,3) for connecting the contacts of the safety components are shown on the left, in yellow. The DSC outputs (from 1 to 2) are activated according to the conditions defined in E-GATE and E-STOP (see the E-GATE - E-STOP sections).

By clicking on a block to select it, you enable the PROPERTIES WINDOW on the right, which you can use to configure the block activation and test parameters (see the E-GATE - E-STOP sections).

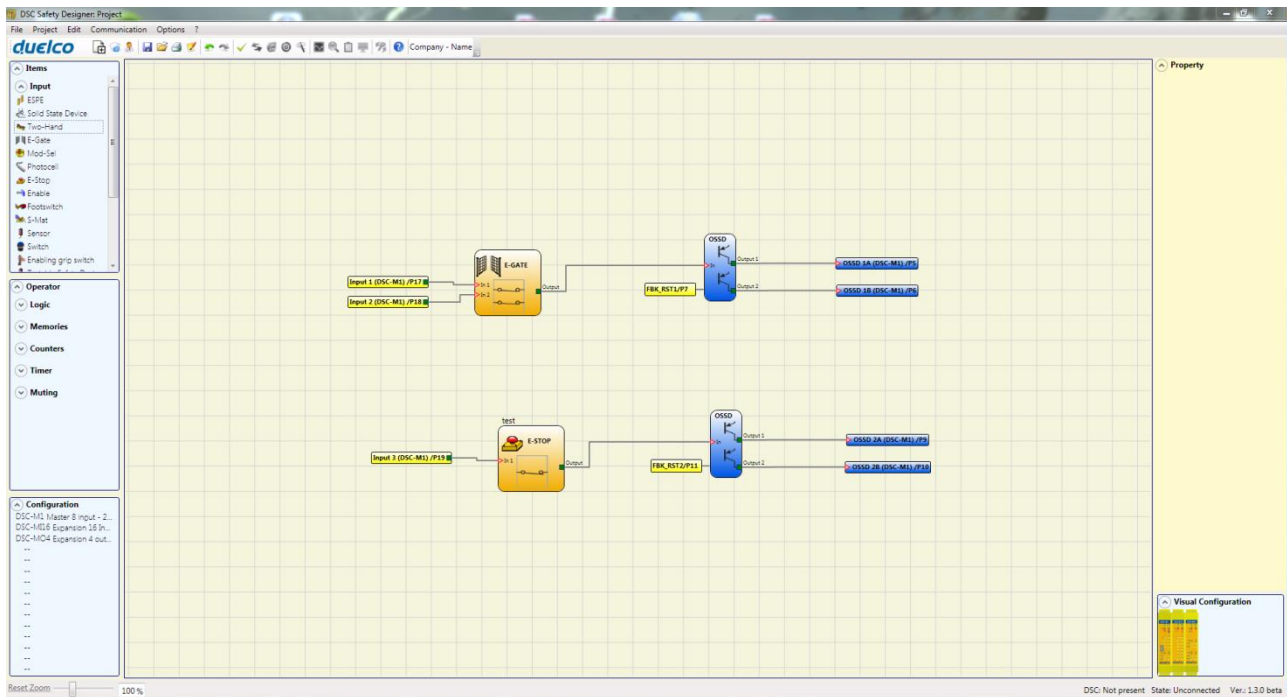



Figure 54

At the end of the project design stage (or at intermediate steps) you can save the current configuration using the icon **SAVE** on the standard tool bar.

## Project validation

➔ Now the finished project must be verified. Execute the VALIDATE command (Icon  on the standard toolbar).

If the validation is successful, a sequential number is assigned to the input and output of the project. Then, this number is also listed in the REPORT and in the MONITOR of MSD.

Only if the validation is successful we will proceed to send the configuration.

 The validation function only verifies the consistency of programming with respect to the characteristics of the DSC system. It does not guarantee that the device has been programmed to meet all the safety requirements for the application.

## Resources Allocation

To activate the RESOURCES ALLOCATION function use the icon .

Executing this command, all the used elements among Inputs, Outputs, Status, Fieldbus input and Probe are visible, see the example in figure.

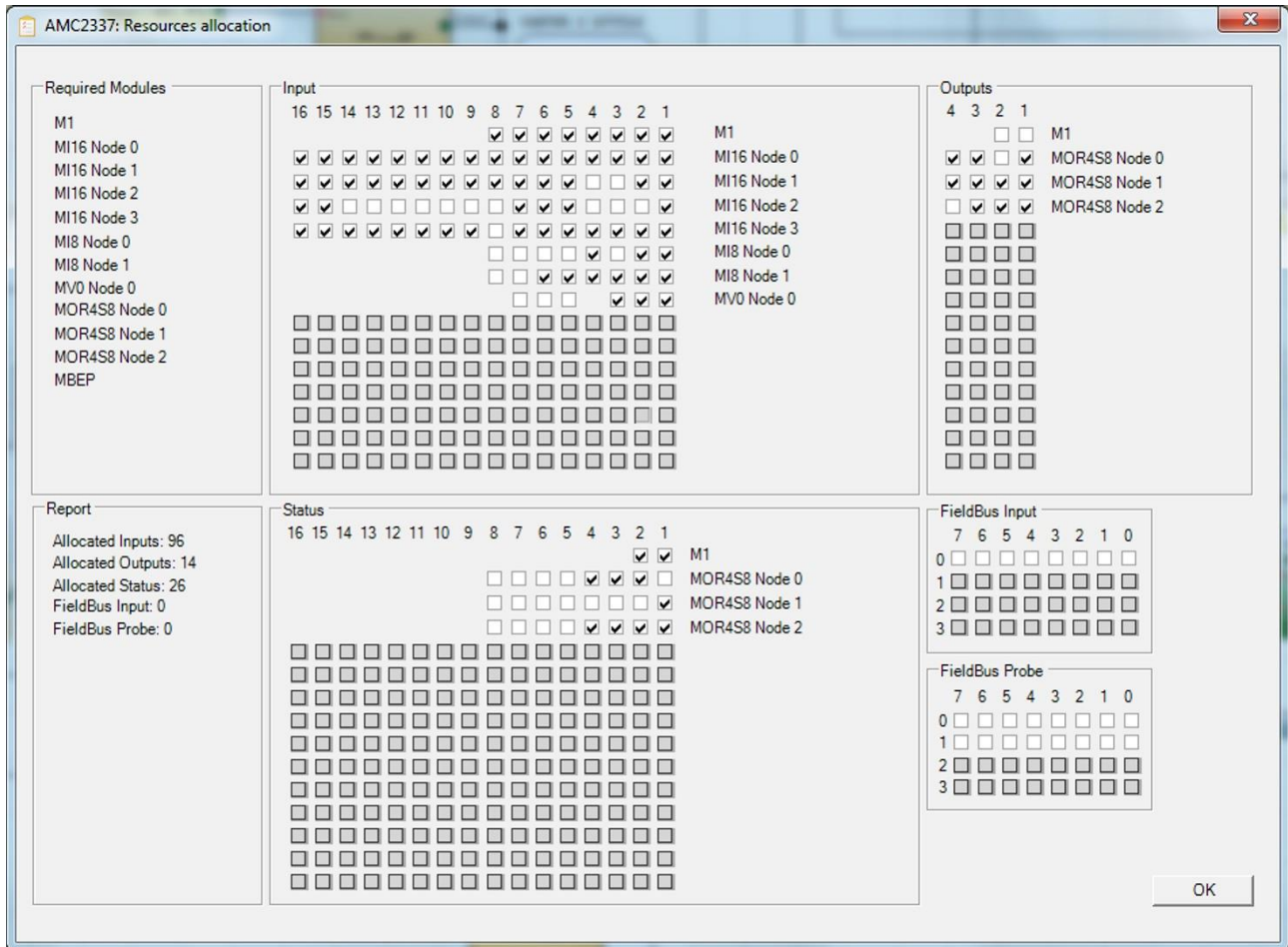



Figure 55

## Project report

Print of the System composition with properties of each block. (Icon  on the standard toolbar).

Duelco Safety solutions

Project Report generated by DSC Safety Designer version 1.3.0



Project Name: Project

User: Name

Company: Company

Date: 13-04-2012 10:45:57

Schematic CRC: 6F5AH

DSC: Configuration

Module DSC-M1 (Configured Firmware version: FW >= 1.0 <1.3)

Module DSC-M11 6 Node 0 (Minimum Required Firmware version: 0.1)

Module DSC-MO4 Node 0 (Minimum Required Firmware version: 0.0)

DSC: Safety Information's

PFHd (according to IEC 61508): 1,66E-008 (1/h)

MTTFd (according to EN ISO 13849-1): 100 years

DCavg (according to EN ISO 13849-1): 97.78 %

Attention!

This definition of PL and of the other related parameters as set forth in ISO 13849 1 only refers to the functions implemented in the DSC system by the DSD configuration software, assuming configuration has been performed correctly.

The actual PL of the entire application and the relative parameters must consider data for all the devices connected to the DSC system within the scope of the application.

This must only be performed by the user/installer.

Resources used

INPUT: 12% (3/24)

Functional Blocks: 2

Total number blocks: 0% (0/64)

OSSD: 33% (2/6)

STATUS: 0% (0/6)

Electrical diagram

E-Gate

Functional Block 1

Filter (ms): 3

Reset Type: Automatic

StartUp Test: False

Double NC

Connections:

DSC-M1 INPUT1/Terminal17

DSC-M1 INPUT2/Terminal18

E-Stop (test)

Functional Block 2

Filter (ms): 3

Reset Type: Automatic

StartUp Test: False

Single

Connections:

DSC-M1 INPUT3/Terminal19

OSSD1

Reset Type: Automatic

Response time: 15,778 ms

Dependence on inputs:

Functional Block 1

Connections:

DSC-M1 OSSD1 A/Terminal15

Figure 56

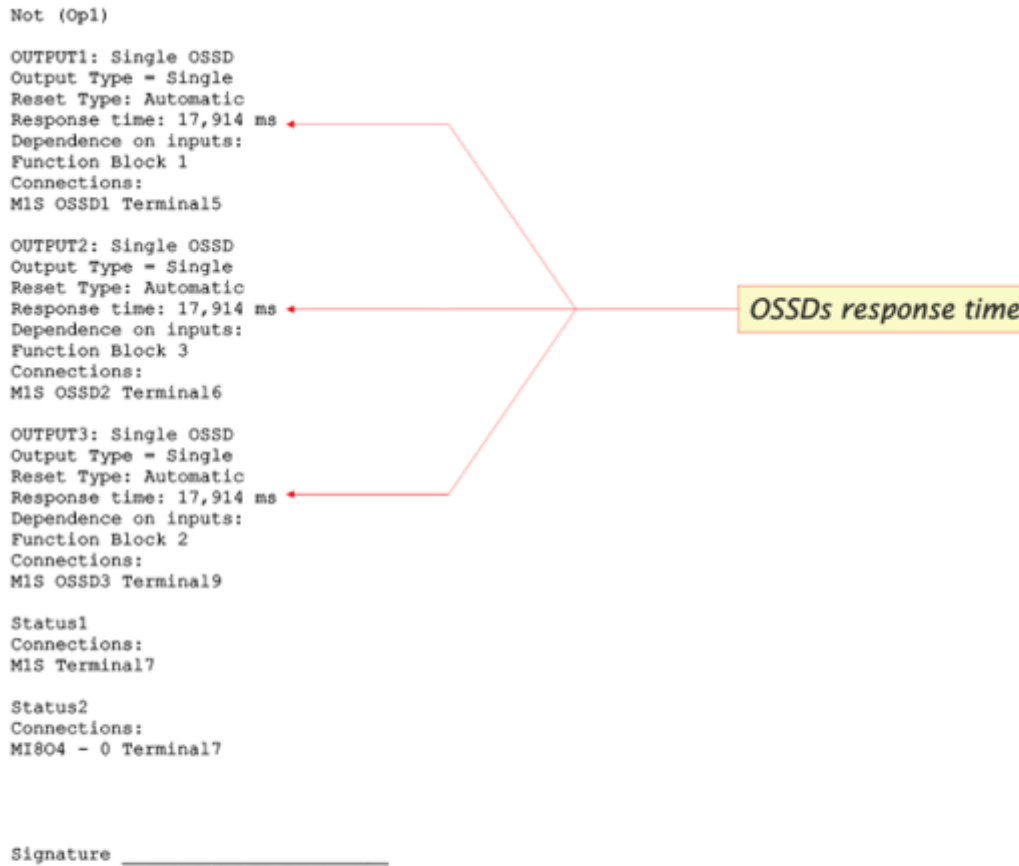



Figure 57

- ✦ This definition of PL and of the other related parameters as set forth in ISO 13849-1 only refers to the functions implemented in the DSC system by the MSD configuration software, assuming configuration has been performed correctly.
- ✦ The actual PL of the entire application and the relative parameters must consider data for all the devices connected to the DSC system within the scope of the application.
- ✦ This must only be performed by the user/installer.

## Connect to DSC

After connecting M1 or M1S to the PC via CSU cable (USB) use the icon  for the connection.

A window appears to request the password. Enter the password (see "Password protection").

- ➔ If a remote connection (via internet) is needed M1 can connect to the appropriate devices through its USB port.
- ➔ In this case (ONLY WITH FW  $\geq$  3.0.1) select "Remote connection".

Select here if the connection is from a PC **not** directly connected to DSC via USB (remote connection)



Figure 58

## Sending the configuration to the DSC

To send the saved configuration from a PC to M1 or M1S use the icon  on the standard toolbar and wait the execution. M1/M1S will save the project in its internal memory and (if present) in DSC-MCM memory. (Password Required: level 2).

- ➔ This function is possible only after project validation with OK result.

## Download a configuration file (project) from DSC

To download a project from DSC M1 or M1S to MSD use the icon  on the Standard toolbar.

MSD will display the project residing in M1 or M1S. (Level 1 password is enough).

- ➔ If the project must be used on other DSC system verify the modules effectively connected (ref. "**System composition**" on page 97).
- ➔ Then perform a "**Project Validation**" (page 92) and a "**System Test**" (page 101).

## Configuration LOG

- ➔ Within the configuration file (project), are included the **creation date** and **CRC (4-digit hexadecimal identification)** of a project that are stored in M1 or M1S.
- ➔ If M1S is used, it is also indicated whether the schematic was loaded via MSD or via DSC-MCM memory
- ➔ This logbook can record up to 5 consecutive events, after which these are overwritten, starting from the least recent event.

The log file can be visualized using the icon  in the standard tool bar. (Password Required: level 1).



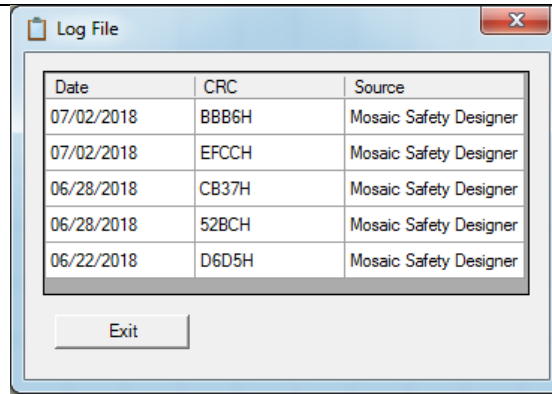

Figure 59

### System composition

The check of the actual composition of the DSC system is obtained using the icon (Password Required: level 1). A pop-up window will appear with:

- Connected modules;
- Firmware version of each module;
- Node number (physical address) of each module.

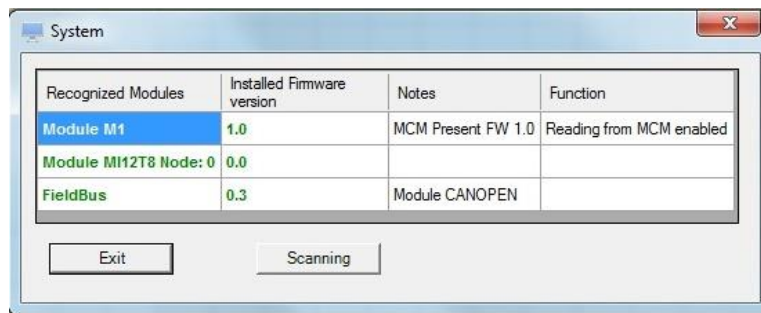

Figure 60

If the modules found are not correct the following window will appear; e.g. MI12T8 node number not correct (displayed in red color text).

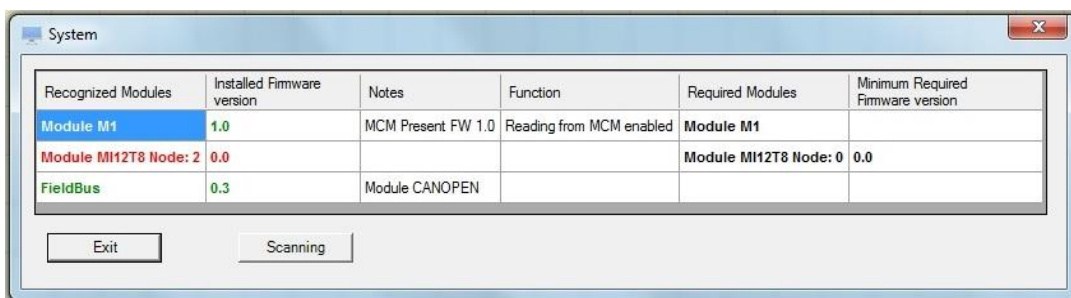



Figure 61

### Disconnecting System

To disconnect the PC from M1/M1S use the icon ; when the system is disconnected it is resetted and it starts with the sent project.

➔ If the system is not composed of all modules provided by the configuration, after the disconnection M1/M1S indicates the incongruity and does not starts. (See SIGNALS).

**MONITOR (I/O status in real time - textual)**

To activate the MONITOR function use the icon . (Password Required: level 1).  
A pop-up window will appear with (all in real time):

- input's state (when the object has two or more input connections to DSC, the MONITOR will show as active only the first), see the example in figure;
- Input's/Out\_test Diagnostics;
- OSSD's State;
- OSSD's Diagnostics;
- Signaling OUTPUT's state;

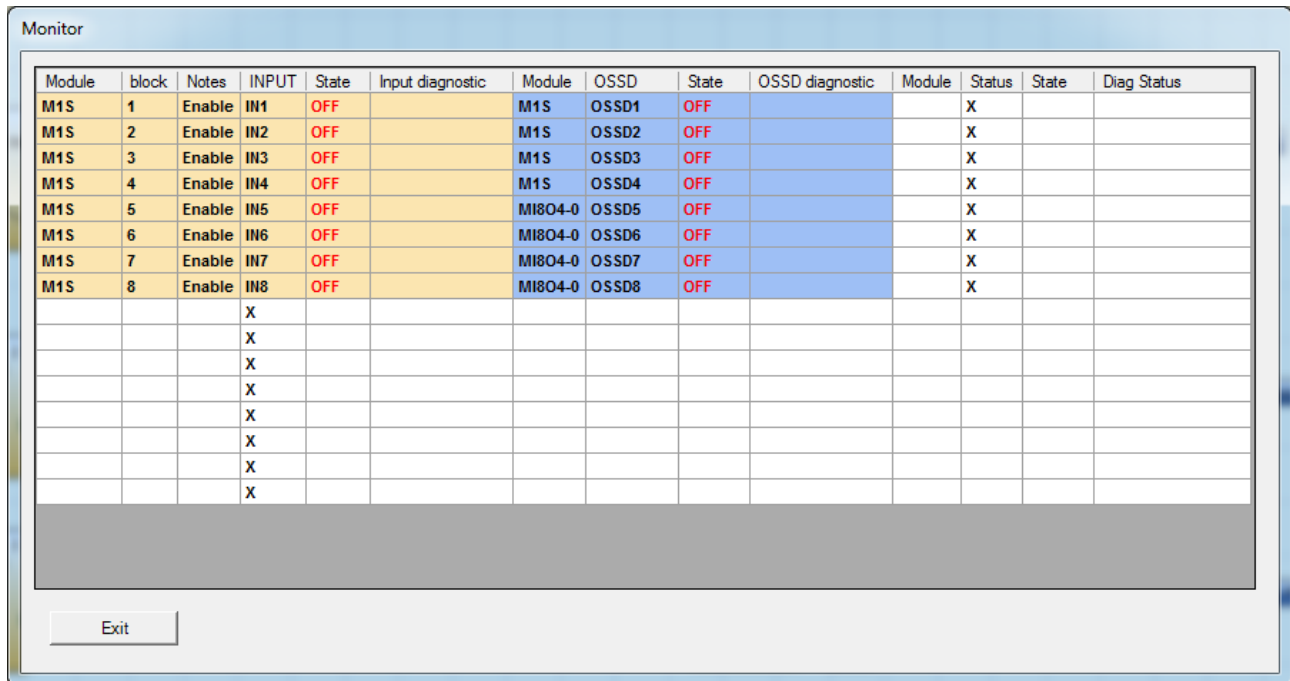

Module	block	Notes	INPUT	State	Input diagnostic	Module	OSSD	State	OSSD diagnostic	Module	Status	State	Diag Status
M1S	1	Enable	IN1	OFF		M1S	OSSD1	OFF			X		
M1S	2	Enable	IN2	OFF		M1S	OSSD2	OFF			X		
M1S	3	Enable	IN3	OFF		M1S	OSSD3	OFF			X		
M1S	4	Enable	IN4	OFF		M1S	OSSD4	OFF			X		
M1S	5	Enable	IN5	OFF		MI804-0	OSSD5	OFF			X		
M1S	6	Enable	IN6	OFF		MI804-0	OSSD6	OFF			X		
M1S	7	Enable	IN7	OFF		MI804-0	OSSD7	OFF			X		
M1S	8	Enable	IN8	OFF		MI804-0	OSSD8	OFF			X		
			X										
			X										
			X										
			X										
			X										
			X										
			X										
			X										

Figure 62 - textual monitor

**MONITOR (I/O status in real time - textual - graphic)**

To activate/deactivate the monitor use the icon . (Password Required: level 1).  
The color of links (Figure 33) allows you to view the diagnostics (in real time) with:

- RED** = OFF
- GREEN** = ON
- DASHED ORANGE** = Connection Error
- DASHED RED** = Pending enable (for example RESTART)

➔ Placing the mouse pointer over the link, you can display the diagnostics.

**PARTICULAR CASES**

- ➔ NETWORK OPERATOR, signals NETWORK IN, OUT:  
 RED CONTINUOUS LINE = STOP  
 GREEN CONTINUOUS LINE = RUN  
 ORANGE CONTINUOUS LINE = START
- ➔ SERIAL OUTPUT OPERATOR:  
 BLACK CONTINUOUS LINE = data in transmission

english

The schematic can't be changed during the monitor. It is possible to display the parameters of a component by clicking on it with the right mouse button, choosing "Show/Hide Properties".

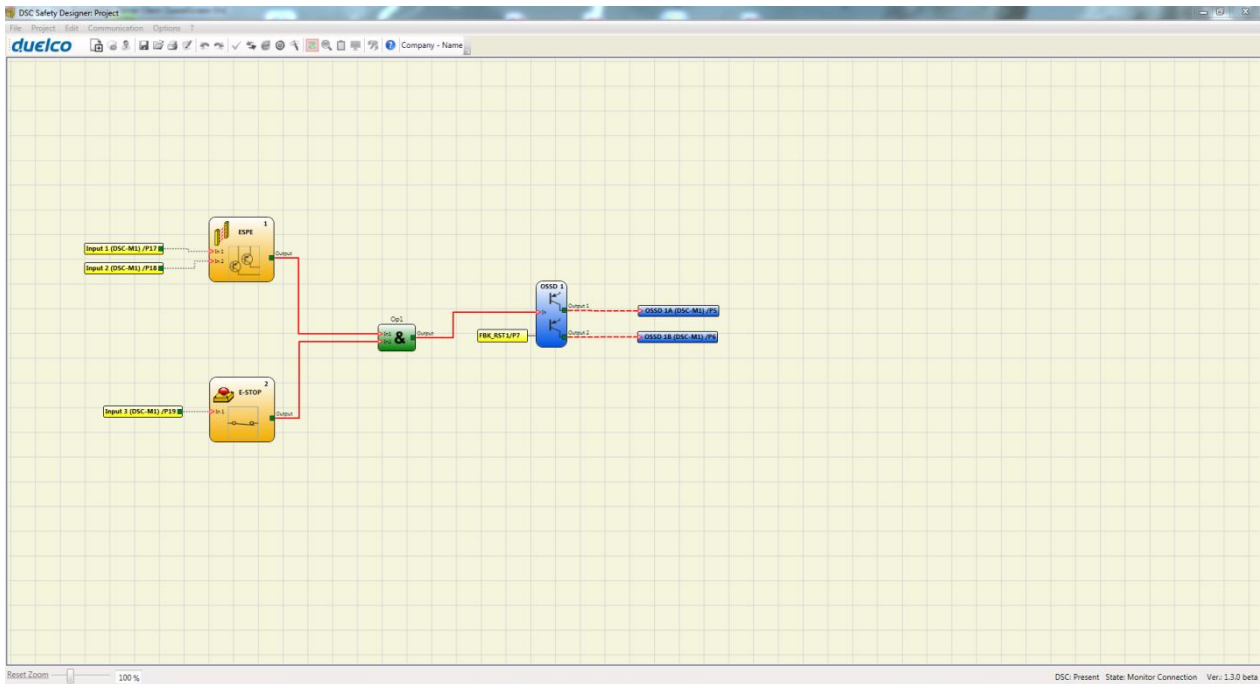

Figure 63 - graphical monitor

## Password protection

The MSD requests a password in order to upload and save the project.

- ➔ The password entered as default must be modified to avoid manipulation (level 2 password) or so that the configuration loaded on DSC (level 1 password) is not visible.

## Level 1 password

All operators using the M1/M1S system must have a Level 1 PASSWORD.

This password allows only to view the configuration and error LOGs, composition of the system and MONITOR in real time and upload operations.

For the first time the password is "" (ENTER key).

Designers who know the level 2 password can enter a new level 1 password (alphanumeric, max 8 characters).

- ➔ Operators who know this password are **enabled** to upload (from M1/M1S to PC), modify or save the project.

## Level 2 password

Designers authorised to work on the creation of the project must know a Level 2 PASSWORD. The first time the system is initialised the operator must use the password "SAFEPASS" (all capital letters).

Designers who know the level 2 password can enter a new level 2 password (alphanumeric, max 8 characters).

With the Level 2 password, the designers authorized has available all the functions of Level plus the ability to download the project from PC to DSC and change the passwords

- ➔ This password **enables** the project to be uploaded (from PC to M1), modified and saved. In other words, it allows total control of the PC => DSC system.
- ➔ When a new project is UPLOADED the level 2 password could be changed.
- ➔ Should you forget either of these passwords, please contact Duelco which will provide an unlock file (when the unlock file is saved in the right directory the icon 🗝️ will appear on the toolbar). When the icon is activated, the password level 1 and level 2 are restored to their original values. This password is only given to the designer and can only be used once.

## Password Change

To activate the PASSWORD Change use icon 🗝️, after connecting with Level 2 Password. A window appears (Figure 64) allowing the choice of the new password; insert the old and new passwords in the appropriate fields (max 8 characters). Click OK.

At the end of the operation disconnect to restart the system.

If DSC-MCM is present the new password is also saved in it.

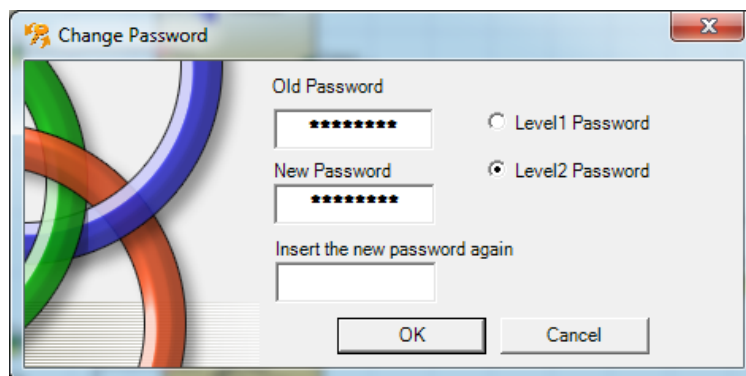

Figure 64

## TESTING the system

**After validating and uploading the project to the M1/M1S and connecting all the safety devices, you must test the system to verify its correct operation.**

This is done by forcing a change of status for each safety device connected to the DSC to check that the status of the outputs actually changes.  
The following example is helpful for understanding the TEST procedure.

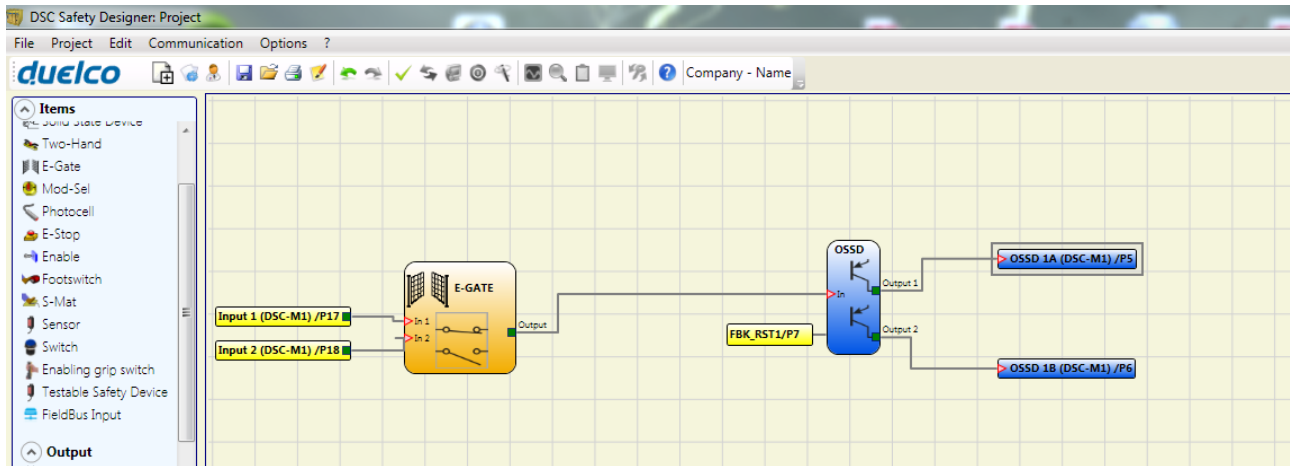
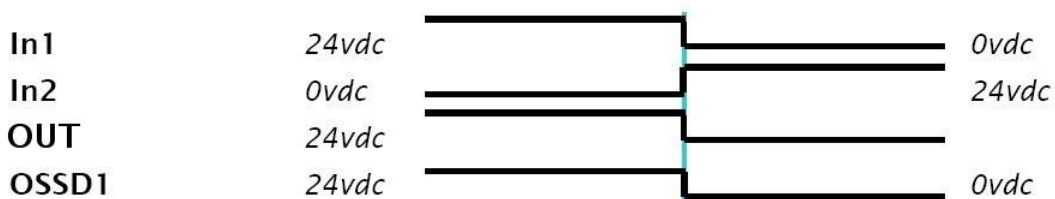

Figure 65

- (t1) In the normal operating condition (E-GATE closed) Input1 is closed, Input2 is open and the output of the E-GATE block is set to high logic level; in this mode the safety outputs (OSSD1/2) are active and the power supply to the relative terminals is 24VDC.
- (t2) When the E-GATE is **physically** opened, the condition of the inputs and thus of the outputs of the E-GATE block will change: (OUT= 0VDC--->24VDC); **the condition of the OSSD1-OSSD2 safety outputs will change from 24VDC to 0VDC.** If this change is detected the mobile E-GATE is connected correctly.



**For the correct installation of each external sensor/component refer to their installation manual.**  
**This test must be performed for each safety component in the project.**

# OBJECT FUNCTION BLOCKS

## OUTPUT OBJECTS

### OSSD (safety outputs)

OSSD safety outputs which use semiconductor technology do not require maintenance, Output1 and Output2 supply 24Vdc if the In is 1 (TRUE) and vice versa 0Vdc if the In is 0 (FALSE).

➔ Each pair of OSSD outputs has a relative RESTART\_FBK input. This input must always be connected as indicated in the RESTART\_FBK paragraph.

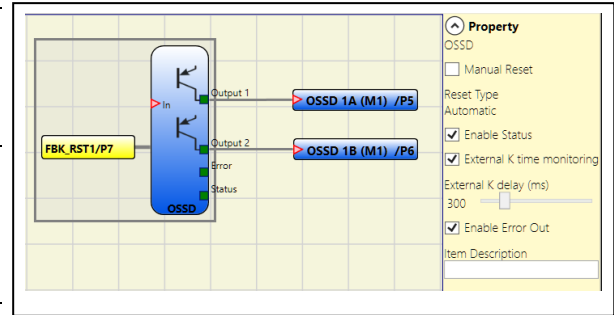

### Parameters

**Manual Reset:** If selected this enables the request to reset each time the input signal falls. Otherwise, output enabling directly follows In input conditions.

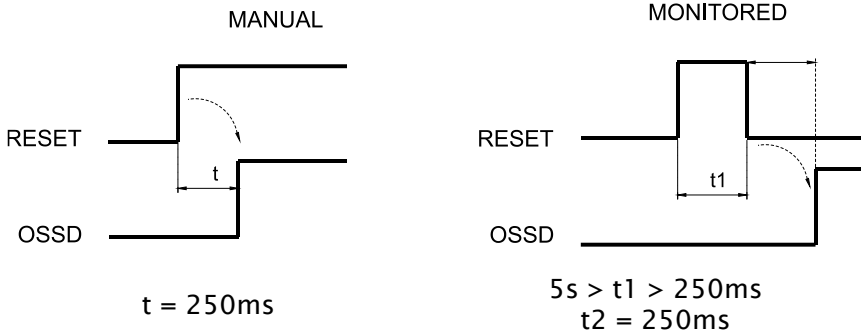

There are two types of reset: Manual and Monitored. In selecting the Manual option only signal transition from 0 to 1 is verified. If the Monitored option is selected, the double transition from 0 to 1 and back to 0 is verified.

**Enable Status:** If selected, enables the connection of the current OSSD state to any point on the screen.

**K external time check:** If selected, enables the setting of the time window within which the external feedback signal is to be monitored (according to output conditions).

With high level (TRUE) OUTPUT, the FBK signal must be at low level (FALSE) and vice versa, within the set time. Otherwise, OUTPUT is set to low level (FALSE) and the error is indicated on the master M1 by the flashing CLEAR LED corresponding to the OSSD in error.

**Enable Error Out** If selected, enables the ERROR OUT output. **This output is set to high level (TRUE) when an external FBK error is detected.**

The **Error Out** signal is reset in case of one of the following events:

1. Switching on and switching off of system.
2. Activation of the RESET M1 operator.

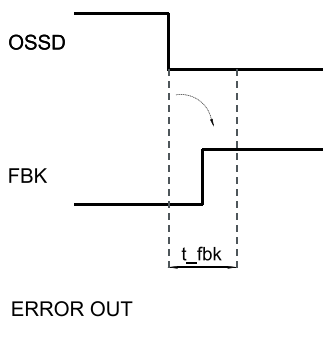

Example of OSSD with correct Feedback signal:  
In this case ERROR OUT=FALSE

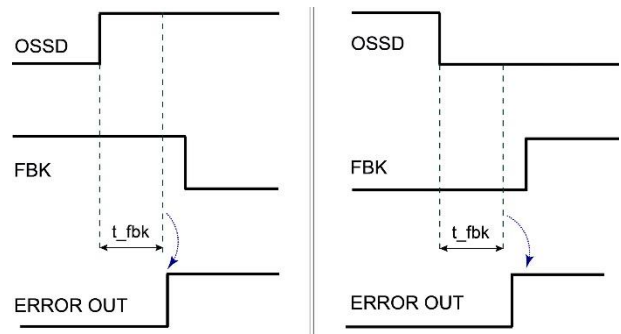

Example of OSSD with incorrect Feedback signal (k external time exceeded):  
In this case ERROR OUT=TRUE

## SINGLE OSSD (safety output)

SINGLE OSSD safety output uses semiconductor technology and do not require maintenance, Output1 supplies 24Vdc if the In is 1 (TRUE) and vice versa 0Vdc if the In is 0 (FALSE).

➔ Each SINGLE OSSD output provides a relative RESTART\_FBK input. This input, in the case of M1S and MI8O4, appears only if the manual reset or the EDM time control is activated. In case of MO4LHCS8, it always appears and must be connected as indicated in the RESTART\_FBK paragraph.

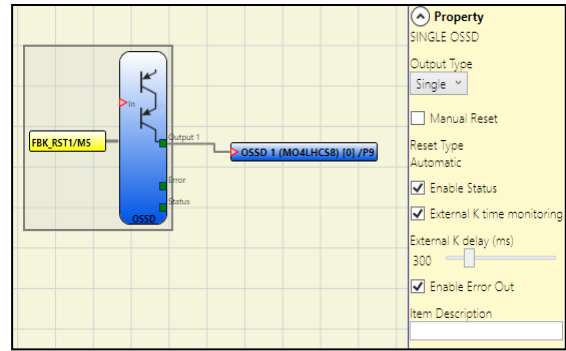

## Parameters

**Output Type:** There is a choice of 2 different output type:

- Single Output Type
- Double Output Type

Using M1S, MI8O4, MO4LHCS8 modules, the operator can choose between different configurations:

1. Four SINGLE OUTPUTS function blocks (*single output type*)
2. Two SINGLE OUTPUTS function blocks (*double output type*)
3. Two SINGLE OUTPUTS function blocks (*single output type*) + one SINGLE OUTPUTS function block (*double output type*)

- ⚠ Using single channels OSSD, to maintain Safety Integrity Level (SIL) "3" requirements the OSSD outputs must be independent.
- ⚠ Common cause failures between OSSD outputs must be excluded by observing an appropriate cable installation (i.e. separate cable paths).

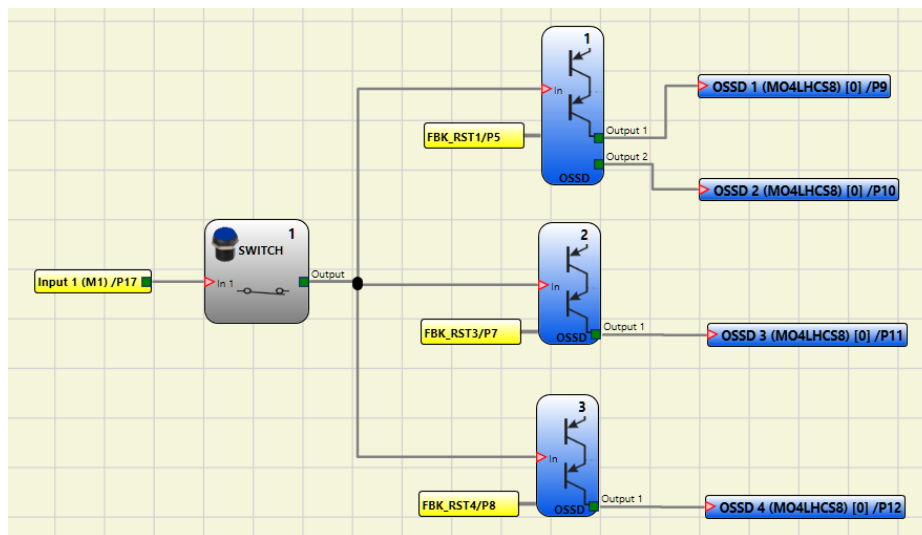

Example of project  
2 single output type function blocks + 1 double output type function blocks

Here below you can find the explanation of the M1S, MI8O4, MO4LHCS8 Single OSSDs configuration.

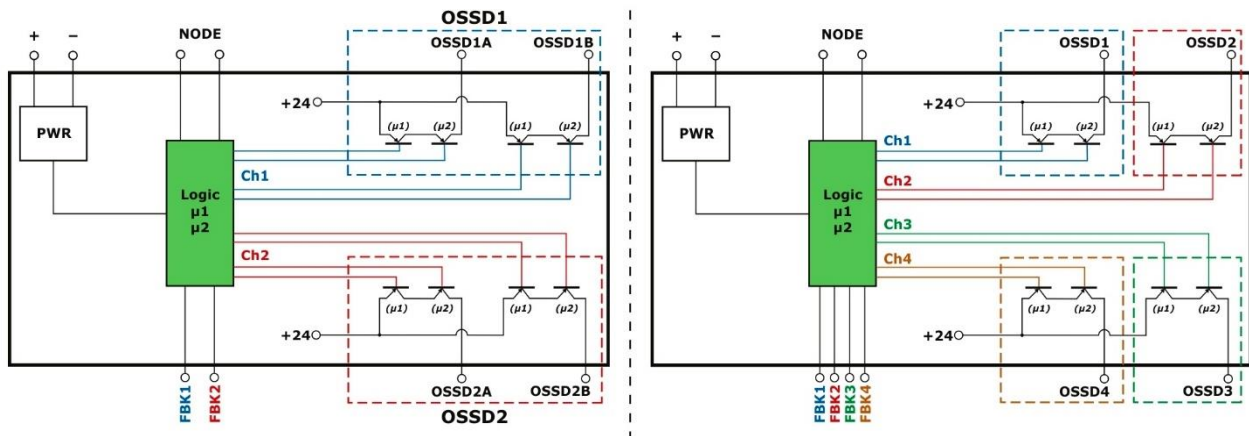

**Manual Reset:** If selected this enables the request to reset each time the input signal falls. Otherwise, output enabling directly follows In input conditions.

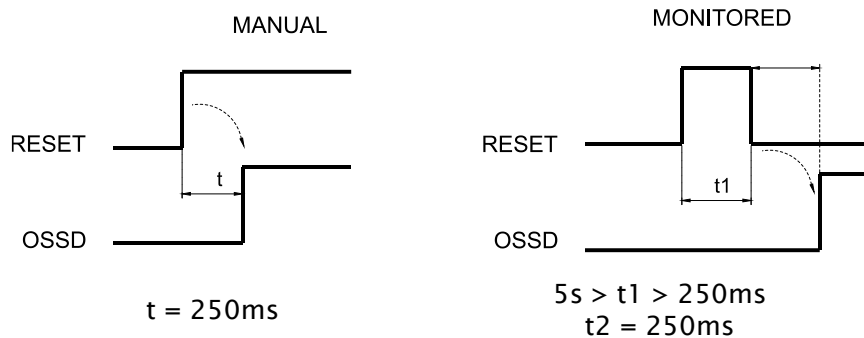

There are two types of reset: Manual and Monitored. In selecting the Manual option only signal transition from 0 to 1 is verified. If the Monitored option is selected, the double transition from 0 to 1 and back to 0 is verified.

**Enable Status:** If selected, enables the connection of the current OSSD state to any point on the screen.

**K external time check:** If selected, enables the setting of the time window within which the external feedback signal is to be monitored (according to output conditions).

With high level (TRUE) OUTPUT, the FBK signal must be at low level (FALSE) and vice versa, within the set time.

Otherwise, OUTPUT is set to low level (FALSE) and the error is indicated on the master M1 by the flashing CLEAR LED corresponding to the OSSD in error.



**Enable Error Out** If selected, enables the ERROR OUT output. **This output is set to high level (TRUE) when an external FBK error is detected.**

The **Error Out** signal is reset in case of one of the following events:

3. Switching on and switching off of system.
4. Activation of the RESET M1 operator.

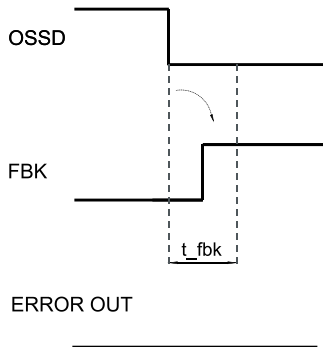

**Example of OSSD with correct Feedback signal:**  
In this case ERROR OUT=FALSE

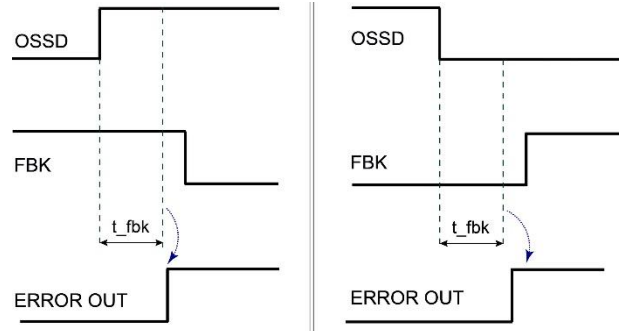

**Example of OSSD with incorrect Feedback signal (k external time exceeded):**  
In this case ERROR OUT=TRUE

## STATUS (signal output)

STATUS output (NOT SAFETY OUTPUT) makes it possible to monitor any point on the diagram by connecting it to the input.

The output returns 24Vdc if the input is 1 (TRUE), or 0Vdc if the input is 0 (FALSE).

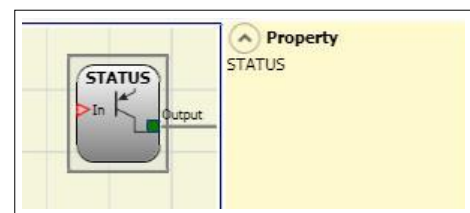

**WARNING:** The STATUS output is NOT a safety output.

## FIELDBUS PROBE

Element that permits display of the status of any point of the scheme on the fieldbus.

It is possible to insert a maximum of 32 probes with M1S and MBx fw  $\geq 2.0$  and 16 with M1 or MBx fw  $< 2.0$ .

The bit on which status is to be represented must be selected for each.

On the fieldbus the states are represented with 4 bytes with M1S and 2 bytes with M1.

*(For more detailed information, consult the fieldbus manual on the MSD CD-ROM).*

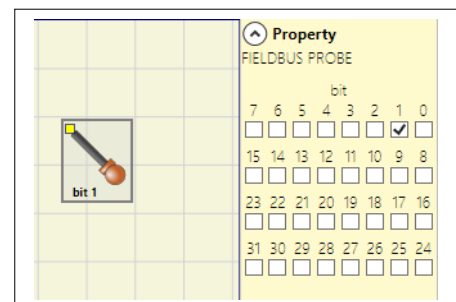

**WARNING:** the PROBE output is NOT a safety output

**RELAY**

The Output relay is a N.O. relay output. Relay outputs are closed when the input **IN** is equal to 1 (TRUE), otherwise they are open (FALSE).

**Parameters**

**Category** There is a choice of 3 different relay output categories:

**Category 1.** Outputs with single Category 1 relay. Each MOR4/S8 unit may have up to 4 of these outputs.

Features:

- Internal relays are monitored.
- EDM feedback (check of FBK 1-4) not used (not requested for Category 1).
- Each output can be set as AUTO or MANUAL RESTART.

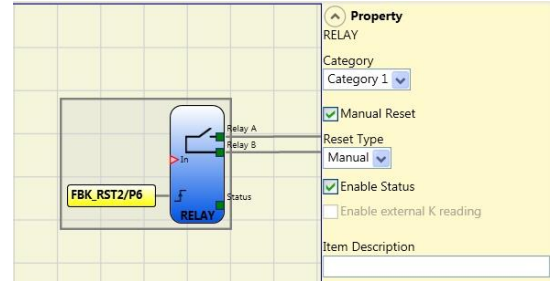

**Example with external relay**

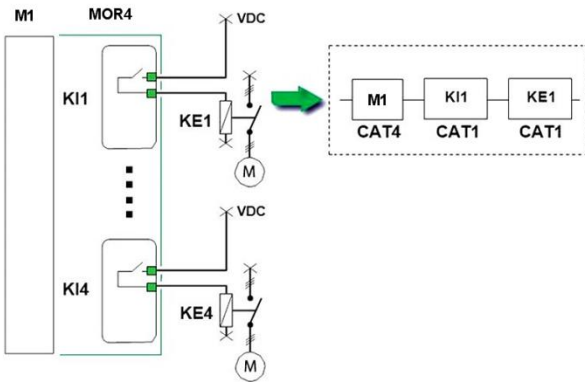

**Example with the internal relay only**

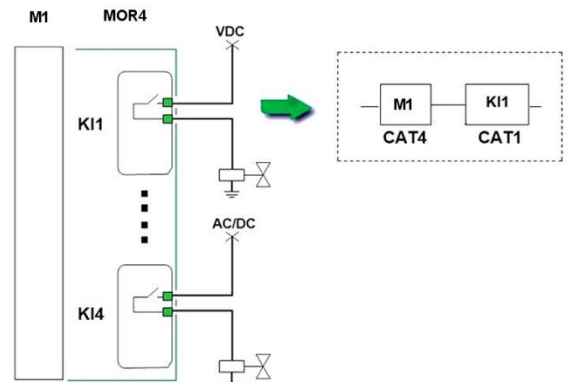

**Category 2.** Outputs with single Category 2 relay with OTE outputs. Each MOR4/S8 unit can have up to 4 of these outputs.

Features:

- Internal relays are always monitored.
- Monitored EDM feedback.
- The output can be configured to Manual or Automatic restart. The EDM feedback monitor cannot be activated with the manual restart. To monitor the EDM feedback must be configured automatic restart. In this case, if you want to use the manual restart shall be provided a dedicated logic. Refer to the following note.

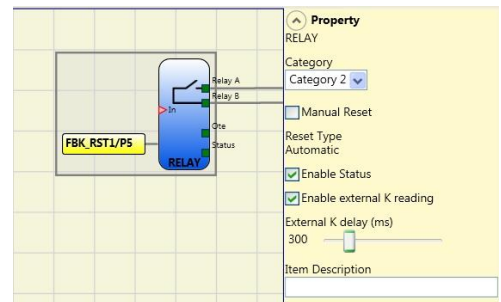

**(Output Test Equipment)**

OTE (Output Test Equipment) is activated; this is necessary with configurations of category 2 for the reporting of hazardous failures in accordance with EN 13849-1: 2006 / DAM1 (under development). OTE output: normally ON. In case of fault of internal feedback or EDM => OFF. This permits to inform the machine logic, with the aim of stopping the dangerous movement or at least signaling the fault to the user.

**OTE:** The OTE (Output Test Equipment) output is normally 1 (TRUE) except in the case of an internal error or a fault associated with feedback from the external contactors (FALSE).

english

Use with RESTART: Automatic (A) or Manual (B) (Category 2)

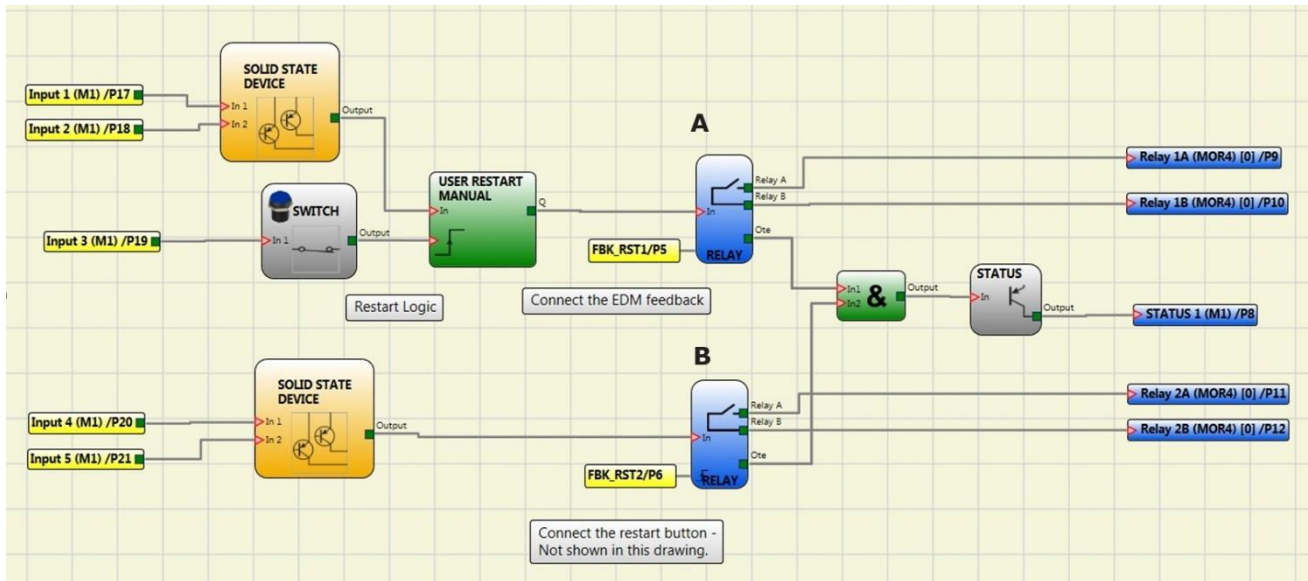
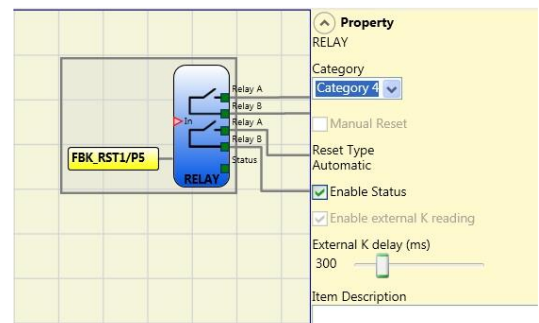

Figure 66

**Category 4.** Outputs with two Category 4 relays. Each MOR4/S8 unit can have up to 2 of these outputs. With this output the relays are controlled in pairs.

Features:

- 2 double channel outputs.
- Double internal relays are monitored.
- Each output can be set as AUTO or MANUAL RESTART.



➔ In order to not affect the outcome of the calculation of the PL, the inputs (sensors or safety devices) must be of a category equal to or higher than the other devices in the chain.

Example of use with only the internal relay and monitored solenoid valves.

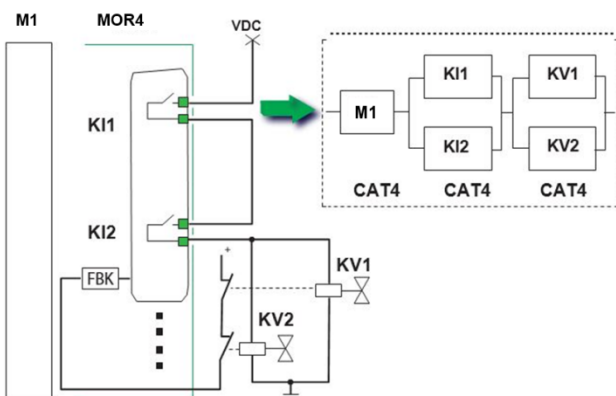

Example of use with external contactors with feedback.

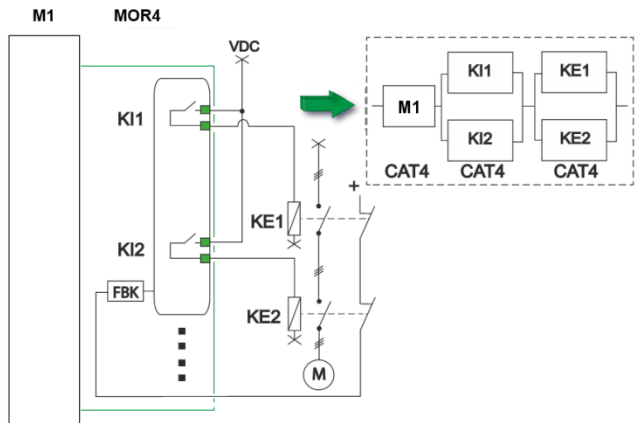

**External K delay (ms):** Select the Maximum delay the external contactors are allowed to introduce. This value can be used to check the maximum delay between switching of the internal relays and switching of the external contactors (during both activation and deactivation).

**Manual Reset:** If selected this enables the request to reset each time the IN input signal falls. Otherwise, the output is enabled directly according to the condition of the IN input.

There are two types of reset: Manual and Monitored. When Manual is selected the system only verifies the signal's transition from 0 to 1. If Monitored is selected, the double transition from 0 to 1 and then back to 0 is verified.

**Enable Status:** If selected, enables the connection of the current RELAY state to any point on the screen.

**Enable reading of external K:** When this is selected it enables reading and verification of external contactor switching times:

- With Category 1 control of external contactors cannot be enabled.
- With Category 4 control of external contactors is mandatory (always enabled).

**Enable Error Out** If selected, enables the ERROR OUT output. **This output is set to high level (TRUE) when an external FBK error is detected.**

The **Error Out** signal is reset in case of one of the following events:

1. Switching on and switching off of system.
2. Activation of the RESET M1 operator.

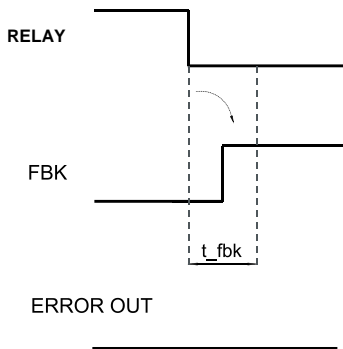

**Example of RELAY with correct Feedback signal:**  
In this case ERROR OUT=FALSE

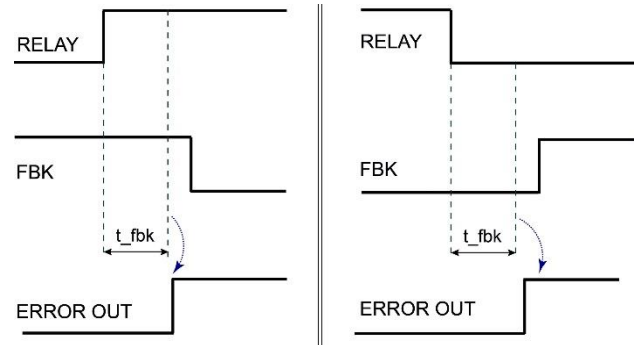

**Example of RELAY with incorrect Feedback signal (k external time exceeded):**  
In this case ERROR OUT=TRUE

## INPUT OBJECTS

### E-STOP (emergency stop)

E-STOP function block verifies an emergency stop device inputs status. If the emergency stop button has been pressed the output is 0 (FALSE). If not the output is 1 (TRUE).

#### Parameters

**Input type:**

- Single NC – allows connection of one-way emergency stops
- Double NC – allows connection of two-way emergency stops .

**Manual reset:** If selected this enables the request to reset each time the emergency stop is activated.

Otherwise, enabling of the output directly follows the input conditions.

There are two types of reset: Manual and Monitored. When Manual is selected the system only verifies the signal's transition from 0 to 1. If Monitored is selected the double transition from 0 to 1 and then back to 0 is verified.

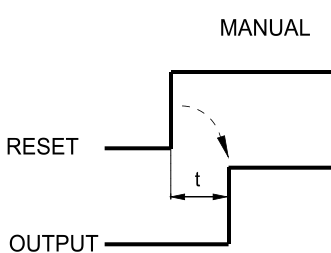
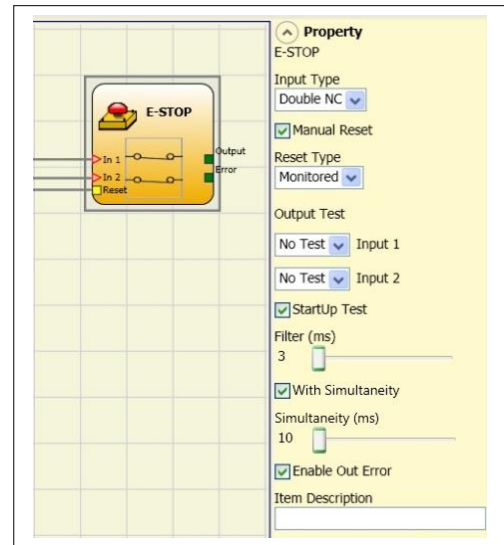

$t = 250ms$

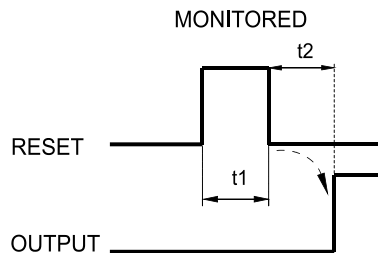

$t1 > 250ms$   
 $t2 = 250ms$

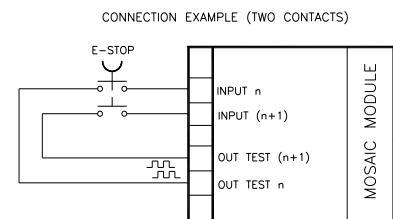
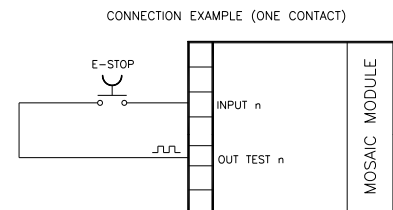

➔ **WARNING:** If the Manual Reset is active, a consecutive Input have to be used. Example : Input 1 and Input 2 are used for the functional block, then Input 3 have to be used for the Reset Input.

**Output test:** This is used to select which test output signals are to be sent to the emergency stop (mushroom pushbutton). This additional test makes it possible to detect and manage any short-circuits between the lines. This additional control permits detection and management of any short-circuits between the lines. To enable this control, the test output signals must be configured (amongst those available).

**Test at start-up:** If selected this enables the test at start-up of the external component (emergency stop). This test is performed by pressing and releasing the pushbutton to run a complete function test and enable the output. This test is only requested at machine start-up (when the unit is switched on).

**Filter (ms):** This is used to filter the signals coming from the emergency stop. The filter can be configured to between 3 and 250 ms and eliminates any bouncing on the contacts. The length of the filter affects the calculation of the unit's total response time.

**With Simultaneity:** If selected this activates the test to verify concurrent switching of the signals coming from the emergency stop.

**Simultaneity (ms):** This is only active if the previous parameter is enabled. It defines the maximum time (in msecs) between the switching of two different signals from the emergency stop.

**Enable Error Out:** If selected reports a fault detected by the function block.

**Item description:** This allows a description of the component's function to be entered. The text is displayed in the top part of the symbol.

### E-GATE (safety gate device)

E-GATE function block verifies a mobile guard or safety gate device input status. If the mobile guard or safety gate is open, the output is 0 (FALSE). Otherwise the output is 1 (TRUE).

#### Parameters

**Input type:**

- Double NC - Allows connection of components with two NC contacts
- Double NC/NO - Allows connection of components with one NO contact and one NC.

➔ With inactive input (block with Output FALSE), connect:

- Contact NO to terminal corresponding to IN1.
- Contact NC to terminal corresponding to IN2.

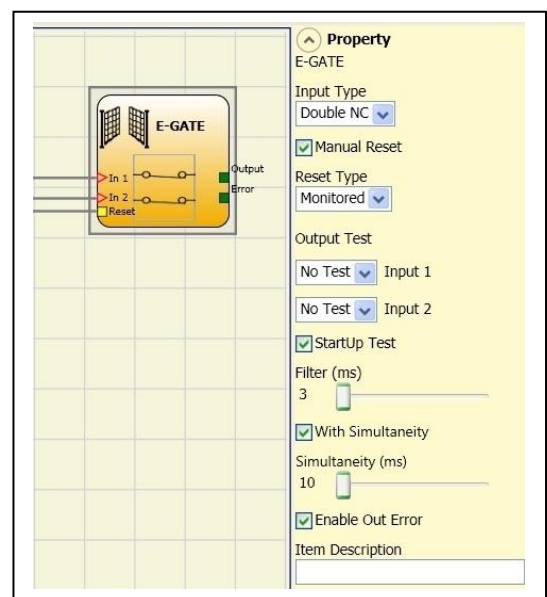

**Enable reset:** If selected this enables the request to reset each time the mobile guard/safety gate is activated. Otherwise, enabling of the output directly follows the input conditions. There are two types of reset: Manual and Monitored. When Manual is selected the system only verifies the signal's transition from 0 to 1. If Monitored is selected the double transition from 0 to 1 and then back to 0 is verified.

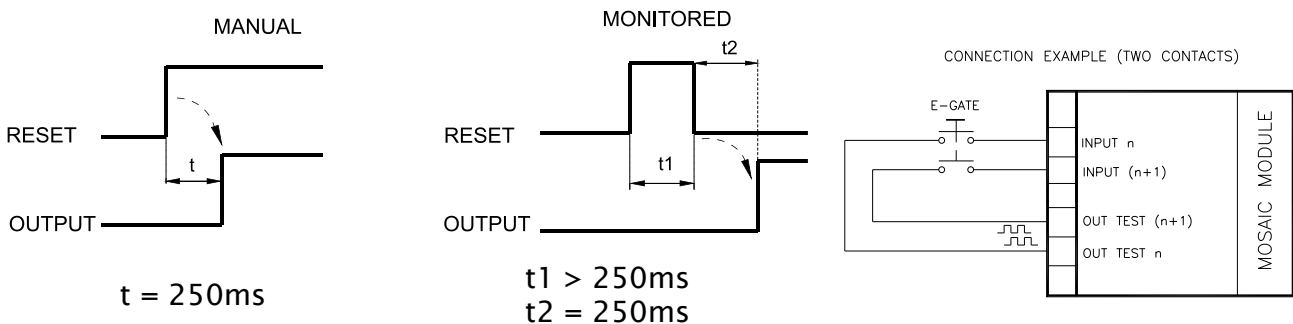

➔ **WARNING:** If the Manual Reset is active, a consecutive Input have to be used. Example : Input 1 and Input 2 are used for the fuctional block, then Input 3 have to be used for the Reset Input.

english

**Output test:** This is used to select which test output signals are to be sent to the component contacts. This additional control permits detection and management of any short-circuits between the lines. To enable this control, the test output signals must be configured (amongst those available).

**Test at start-up:** If selected this enables the test at start-up of the external component. This test is performed by opening the mobile guard or safety gate to run a complete function test and enable the output. This test is only requested at machine start-up (when the unit is switched on).

**Filter (ms):** This is used to filter the signals coming from the external contacts. The filter can be configured to between 3 and 250 ms and eliminates any bouncing on the contacts. The length of the filter affects the calculation of the unit's total response time.

**With Simultaneity:** If selected this activates the test to verify concurrent switching of the signals coming from the external contacts.

**Simultaneity (ms):** This is only active if the previous parameter is enabled. It defines the maximum time (in msecs) between the switching of two different signals from the external contacts.

**Enable Error Out:** If selected reports a fault detected by the function block.

**Item description:** This allows a description of the component's function to be entered. The text is displayed in the top part of the symbol.

## SINGLE E-GATE (safety gate device)

SINGLE E-GATE function block verifies a mobile guard or safety gate device input status. If the mobile guard or safety gate is open, the output is 0 (FALSE). Otherwise the output is 1 (TRUE).

### Parameters

**Enable reset:** If selected this enables the request to reset each time the mobile guard/safety gate is activated. Otherwise, enabling of the output directly follows the input conditions.

There are two types of reset: Manual and Monitored. When Manual is selected the system only verifies the signal's transition from 0 to 1. If Monitored is selected the double transition from 0 to 1 and then back to 0 is verified.

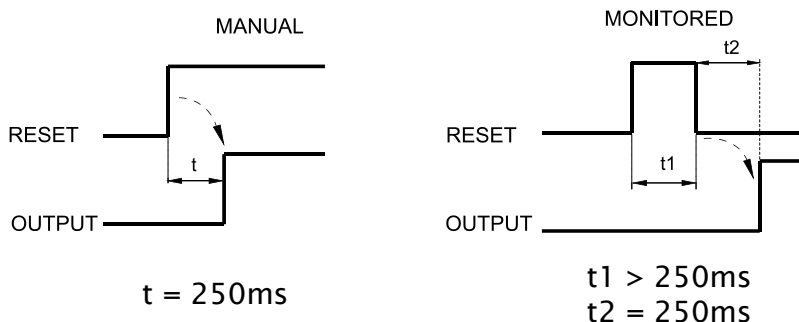
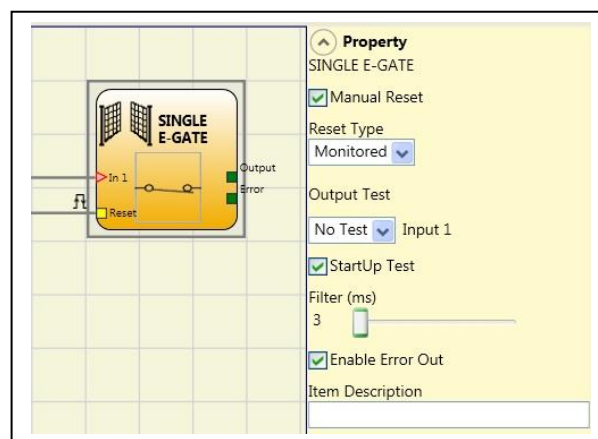

➔ **WARNING:** If the Manual Reset is active, a consecutive Input have to be used. Example : Input 1 and Input 2 are used for the fuctional block, then Input 3 have to be used for the Reset Input.

**Output test:** This is used to select which test output signals are to be sent to the component contacts. This additional control permits detection and management of any short-circuits between the lines. To enable this control, the test output signals must be configured (amongst those available).

**Test at start-up:** If selected this enables the test at start-up of the external component. This test is performed by opening the mobile guard or safety gate to run a complete function test and enable the output. This test is only requested at machine start-up (when the unit is switched on).

**Filter (ms):** This is used to filter the signals coming from the external contacts. The filter can be configured to between 3 and 250 ms and eliminates any bouncing on the contacts. The length of the filter affects the calculation of the unit's total response time.

**Enable Error Out:** If selected reports a fault detected by the function block.

**Item description:** This allows a description of the component's function to be entered. The text is displayed in the top part of the symbol.

## LOCK FEEDBACK

The function block LOCK FEEDBACK verifies the lock status of the guard lock device for mobile guard or safety gate. In the case where the inputs indicate that the guard is locked the Output will be 1 (TRUE). Otherwise the output is 0 (FALSE).

### Parameters

#### Input type

- Single NC - Allows connection of components with one NC contact;
- Double NC - Allows connection of components with two NC contacts.
- Double NC/NO - Allows connection of components with one NO contact and one NC.

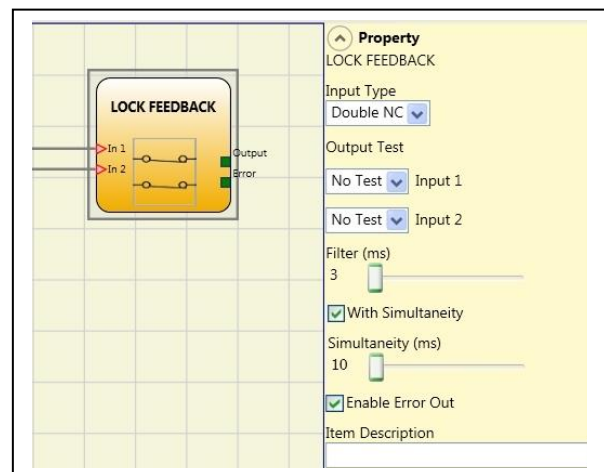

- ➔ With inactive input (guard unlocked), connect:
- Contact NO to terminal corresponding to IN1
  - Contact NC to terminal corresponding to IN2.

**Output test:** This is used to select which test output signals are to be sent to the component contacts. This additional control permits detection and management of any short-circuits between the lines. To enable this control, the test output signals must be configured (amongst those available).

**Filter (ms):** This is used to filter the signals coming from the external contacts. The filter can be configured to between 3 and 250 ms and eliminates any bouncing on the contacts. The length of the filter affects the calculation of the unit's total response time.

**With Simultaneity:** If selected this activates the test to verify concurrent switching of the signals coming from the external contacts.

**Simultaneity (ms):** This is only active if the previous parameter is enabled. It defines the maximum time (in msecs) between the switching of two different signals from the external contacts.

**Enable Error Out:** If selected reports a fault detected by the function block.



**Item description:** This allows a description of the component's function to be entered. The text is displayed in the top part of the symbol.

## ENABLE (enable key)

ENABLE function block verifies a manual key device Input status. If the key is not turned the output is 0 (FALSE). Otherwise the output is 1 (TRUE).

### Parameters

#### Input type

- Single NO – Allows connection of components with one NO contact;
- Double NO – Allows connection of components with two NO contacts.

**Enable reset:** If selected this enables the request to reset each time the command is activated. Otherwise, enabling of the output directly follows the input conditions.

There are two types of reset: Manual and Monitored. When Manual is selected the system only verifies the signal's transition from 0 to 1.

If Monitored is selected the double transition from 0 to 1 and then back to 0 is verified.

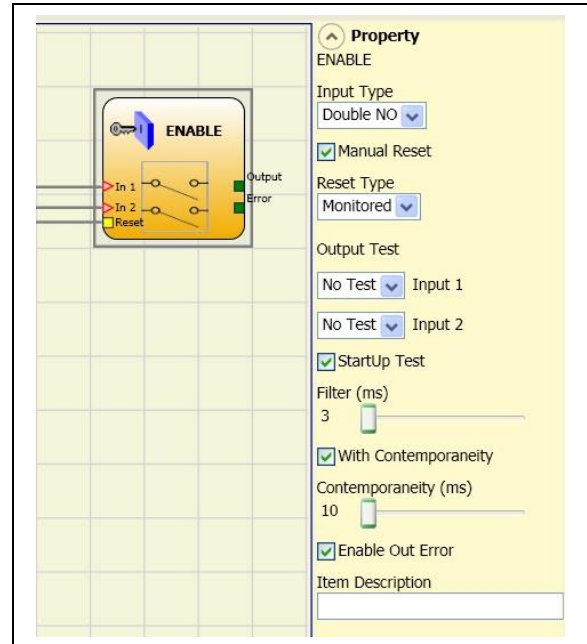

➔ **WARNING:** If the Manual Reset is active, a consecutive Input have to be used. Example : Input 1 and Input 2 are used for the functional block, then Input 3 have to be used for the Reset Input.

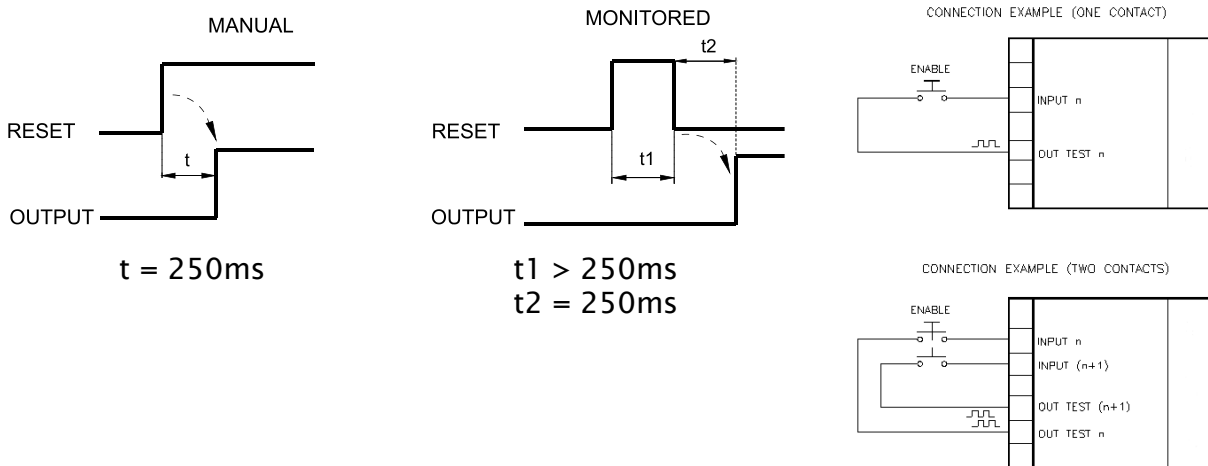

**Output test:** This is used to select which test output signals are to be sent to the component contacts. This additional control permits detection and management of any short-circuits between the lines. To enable this control, the test output signals must be configured (amongst those available).

**Test at start-up:** If selected this enables the test at start-up of the external component. This test is performed by opening and activating the enable key to run a complete function test and enable the output. This test is only requested at machine start-up (when the unit is switched on).

**Filter (ms):** This is used to filter the signals coming from the external contacts. The filter can be configured to between 3 and 250 ms and eliminates any bouncing on the contacts. The length of the filter affects the calculation of the unit's total response time.

**With Simultaneity:** If selected this activates the test to verify concurrent switching of the signals coming from the external contacts.

**Simultaneity (ms):** This is only active if the previous parameter is enabled. It defines the maximum time (in msec) between the switching of two different signals from the external contacts.

**Enable Error Out:** If selected reports a fault detected by the function block.

**Item description:** This allows a description of the component's function to be entered. The text is displayed in the top part of the symbol.

**ESPE (optoelectronic safety light curtain / laser scanner)**

ESPE function block verifies an optoelectronic safety light curtain (or laser scanner) inputs state. If the area protected by the light curtain is occupied, (light curtain outputs FALSE) the output is 0 (FALSE). Otherwise, with the area clear and outputs to 1 (TRUE) the output is 1 (TRUE).

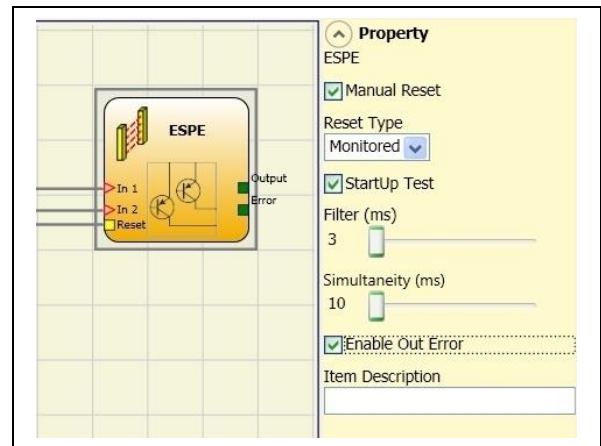

**Parameters**

**Enable reset:** If selected this enables the request to reset each time the area protected by the safety light curtain is occupied. Otherwise, enabling of the output directly follows the input conditions.

There are two types of reset: Manual and Monitored. When Manual is selected the system only verifies the signal's transition from 0 to 1. If Monitored is selected the double transition from 0 to 1 and then back to 0 is verified.

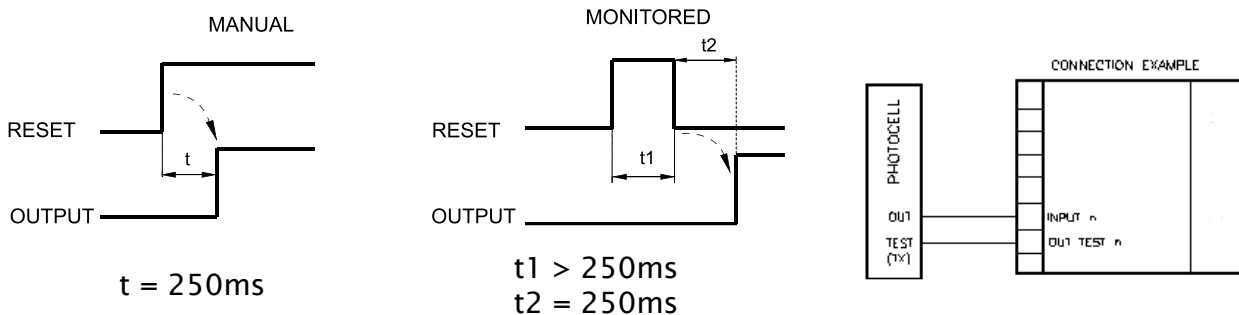

**→ WARNING:** If the Manual Reset is active, a consecutive Input have to be used. Example: Input 1 and Input 2 are used for the functional block, then Input 3 have to be used for the Reset Input.

OUT TEST signals cannot be used in case of safety static output ESPE because the control is carried out from the ESPE.

english

**Test at start-up:** If selected this enables the test at start-up of the safety light curtain. This test is performed by occupying and clearing the area protected by the safety light curtain to run a complete function test and enable the output. This test is only requested at machine start-up (when the unit is switched on).

**Filter (ms):** This is used to filter the signals coming from the safety light curtain. The filter can be configured to between 3 and 250 ms and eliminates any bouncing on the contacts. The length of the filter affects the calculation of the unit's total response time.

**Simultaneity (ms):** always active. Determines the maximum permissible time (msec) between switching of the various signals from the external contacts of the device.

**Enable Error Out:** If selected reports a fault detected by the function block.

**Item description:** This allows a description of the component's function to be entered. The text is displayed in the top part of the symbol.

## FOOTSWITCH (safety pedal)

The FOOTSWITCH function block verifies the status of the inputs of a safety pedal device. If the pedal is not pressed the output is 0 (FALSE). Otherwise the output is 1 (TRUE).

### Parameters

#### Input type:

- Single NC - Allows connection of pedals with one NC contact
- Single NO - Allows connection of pedals with one NO contact.
- Double NC - Allows connection of pedals with two NC contacts
- Double NC/NO - Allows connection of pedals with one NO contact and one NC.

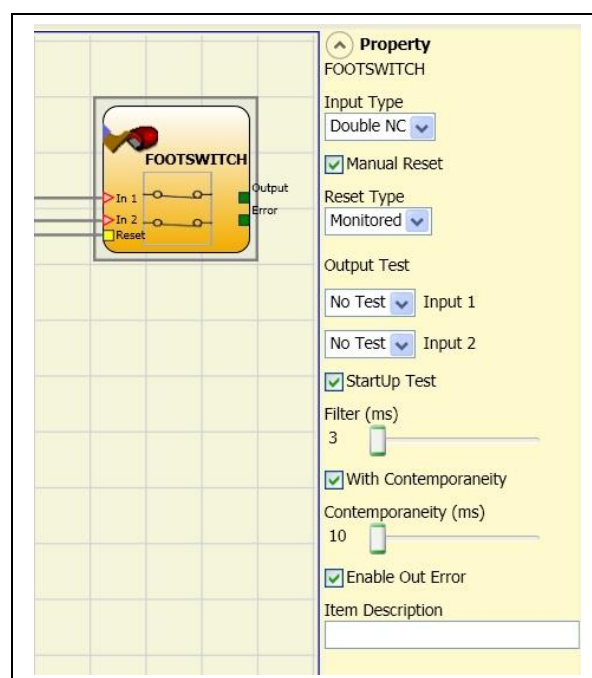

- ➔ With inactive input (block with Output FALSE), connect:
- Contact NO to terminal corresponding to IN1
  - Contact NC to terminal corresponding to IN2.

**Manual reset:** If selected this enables the request to reset each time the safety pedal is activated. Otherwise, enabling of the output directly follows the input conditions. There are two types of reset: Manual and Monitored. When Manual is selected the system only verifies the signal's transition from 0 to 1. If Monitored is selected the double transition from 0 to 1 and then back to 0 is verified.

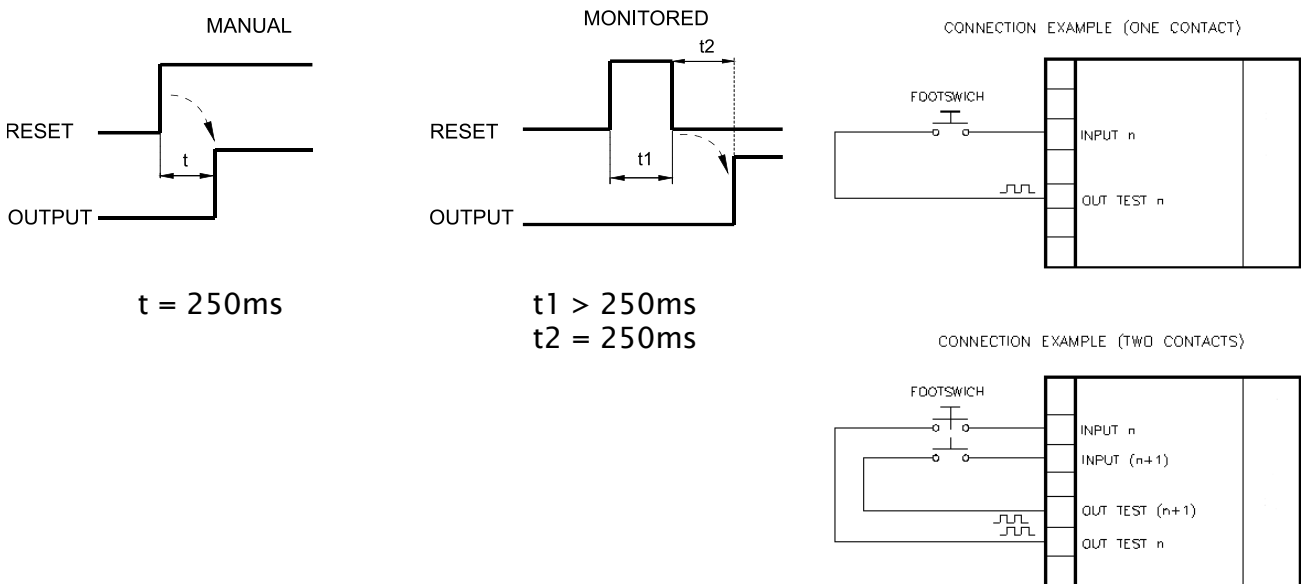

➔ **WARNING:** If the Manual Reset is active, a consecutive Input have to be used. Example: Input 1 and Input 2 are used for the functional block, then Input 3 have to be used for the Reset Input.

**Output test:** This is used to select which test output signals are to be sent to the component contacts. This additional control permits detection and management of any short-circuits between the lines. To enable this control, the test output signals must be configured (amongst those available).

**Test at start-up:** If selected this enables the test at start-up of the external component. This test is performed by pressing and releasing the footswitch to run a complete function test and enable the output. This test is only requested at machine start-up (when the unit is switched on).

**Filter (ms):** This is used to filter the signals coming from the external contacts. The filter can be configured to between 3 and 250 ms and eliminates any bouncing on the contacts. The length of the filter affects the calculation of the unit's total response time.

**With Simultaneity:** If selected this activates the test to verify concurrent switching of the signals coming from the external contacts.

**Simultaneity (ms):** This is only active if the previous parameter is enabled. It defines the maximum time (in msecs) between the switching of two different signals from the external contacts.

**Enable Error Out:** If selected reports a fault detected by the function block.

**Item description:** This allows a description of the component's function to be entered. The text is displayed in the top part of the symbol.

## MOD-SEL (safety selector)

The MOD-SEL function block verifies the status of the inputs from a mode selector (up to 4 inputs): If only one input is 1 (TRUE) the corresponding output is also 1 (TRUE). In all other cases, and thus when all inputs are 0 (FALSE) or more than one input is 1 (TRUE) all the outputs are 0 (FALSE).

### Parameters

#### Input type:

- Double selector - Allows connection of two-way mode selectors.
- Triple selector - Allows connection of three-way mode selectors.
- Quadruple selector - Allows connection of four-way mode selectors.

**Filter (ms):** This is used to filter the signals coming from the mode selector. The filter can be configured to between 3 and 250 ms and eliminates any bouncing on the contacts. The length of the filter affects the calculation of the unit's total response time.

**Simultaneity (ms):** always active. Determines the maximum permissible time (msec) between switching of the various signals from the external contacts of the device.

**Enable Error Out:** If selected reports a fault detected by the function block.

**Item description:** This allows a description of the component's function to be entered. The text is displayed in the top part of the symbol.

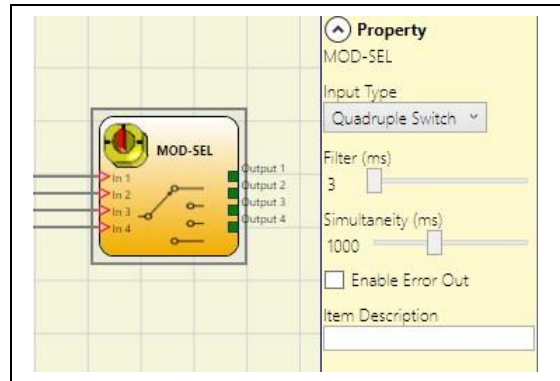

## PHOTOCELL (safety photocell)

The PHOTOCELL function block verifies the status of the inputs of an optoelectronic safety photocell. If the beam of the photocell is occupied (photocell output FALSE) the output is 0 (FALSE). Otherwise with the beam clear and an output of 1 (TRUE) the output is 1 (TRUE).

### Parameters

**Manual reset:** If selected this enables the request to reset each time safety photocell is activated. Otherwise, enabling of the output directly follows the input conditions.

There are two types of reset: Manual and Monitored. When Manual is selected the system only verifies the signal's transition from 0 to 1. If Monitored is selected the double transition from 0 to 1 and then back to 0 is verified.

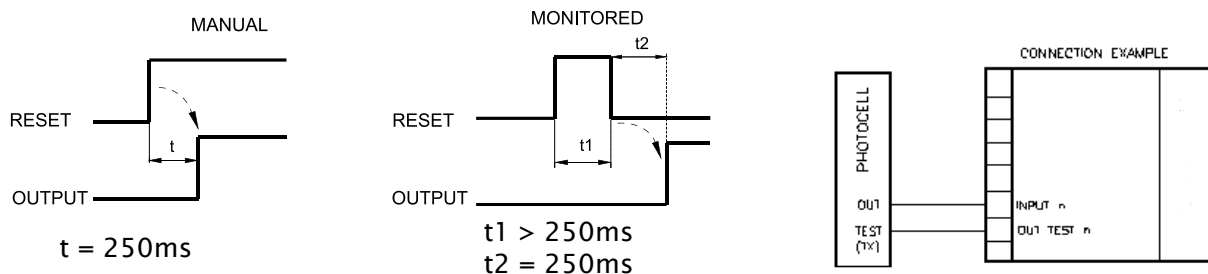
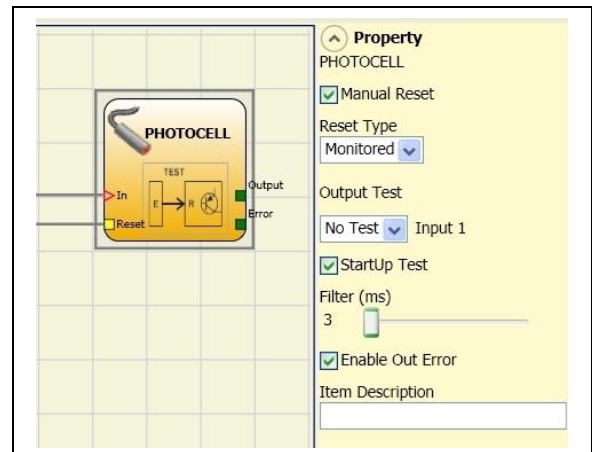

- ➔ An output test signal is mandatory and can be selected from the 4 possible Test Output 1 ÷ 4.
- ➔ If the Manual Reset is active, a consecutive Input have to be used. Example: Input 1 is used for the functional block, then Input 2 have to be used for the Reset Input.
- ➔ The response time of the photocell must be >2ms and <20ms.

**Output test:** This is used to select which test output are to be sent to the photocell test input. This additional control permits detection and management of any short-circuits between the lines. To enable this control, the test output signals must be configured (amongst those available).

**Test at start-up:** If selected this enables the test at start-up of the external component. This test is performed by occupying and clearing the photocell to run a complete function test and enable the output. This test is only requested at machine start-up (when the unit is switched on).

**Filter (ms):** This is used to filter the signals coming from the external contacts. The filter can be configured to between 3 and 250 ms and eliminates any bouncing on the contacts. The length of the filter affects the calculation of the unit's total response time.

**Enable Error Out:** If selected reports a fault detected by the function block.

**Item description:** This allows a description of the component's function to be entered. The text is displayed in the top part of the symbol.

## TWO-HAND (bimanual control)

The TWO HAND function block verifies the status of the inputs of a two hand control switch. Only if both the press-buttons are pressed within 500 msec the output is 1 (TRUE). Otherwise the output is 0 (FALSE).

### Input type:

- Double NO – Allows connection of two-hand switch with one NO contact for each button (EN 574 III A).
- Quadruple NC-NO - Allows connection of two-hand switch with a double NO/NC contact for each button (EN 574 III C).

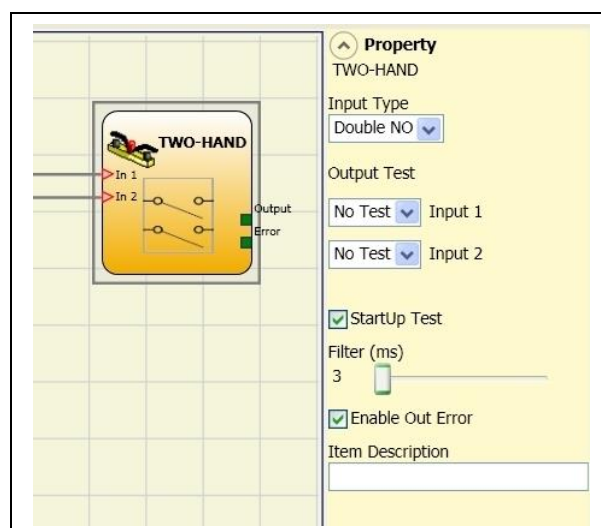

- ➔ With inactive input (block with Output FALSE), connect:
- Contact NO to terminal corresponding to IN1
  - Contact NC to terminal corresponding to IN2.

**Output test:** This is used to select which test output signals are to be sent to the component contacts. This additional control permits detection and management of any short-circuits between the lines. To enable this control, the test output signals must be configured (amongst those available).

**Test at start-up:** If selected this enables the test at start-up of the external component. This test is performed by pressing the two buttons (within 500 ms) and releasing them to run a complete function test and enable the output. This test is only requested at machine start-up (when the unit is switched on).

**Filter (ms):** This is used to filter the signals coming from the mode selector. The filter can be configured to between 3 and 250 ms and eliminates any bouncing on the contacts. The length of the filter affects the calculation of the unit's total response time.

**Enable Error Out:** If selected reports a fault detected by the function block.

**Item description:** This allows a description of the component's function to be entered. The text is displayed in the top part of the symbol.

## NETWORK\_IN

This functional block implements a Network connection input interface; it generates an LL1 in the OUT output when the line is high, otherwise an LL0.

### Parameters

#### Type of input:

- Single - enables the connection of Signalling outputs of an external M1/M1S unit.
- Double - enables the connection of OSSD outputs of an external M1/M1S unit.

**Filter (ms):** Enables the filtering of signals from an external M1/M1S unit. This filter can be set to between 3 and 250ms. The length of the filter affects the calculation of the unit's total response time.

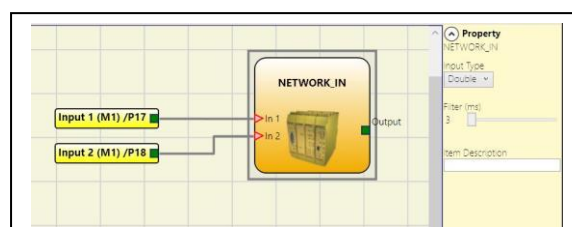

- ➔ This input can only be allocated on M1/M1S and can't be used on expansion modules
- ➔ This input must be used when DSC OSSD outputs are connected to the inputs of a second downstream DSC or together with the NETWORK operator.

## SENSOR

The SENSOR function block verifies the status of the input of a sensor (not a safety sensor). If the beam of the sensor is occupied (sensor output FALSE) the output is 0 (FALSE). Otherwise, with the beam clear and an output of 1 (TRUE) then the output is 1 (TRUE).

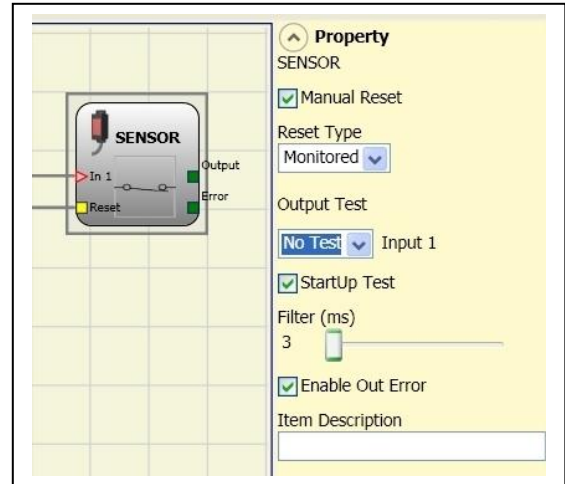

### Parameters

**Manual reset:** If selected this enables the request to reset each time the area protected by the sensor is occupied. Otherwise, enabling of the output directly follows the input conditions.

There are two types of reset: Manual and Monitored. When Manual is selected the system only verifies the signal's transition from 0 to 1. If Monitored is selected the double transition from 0 to 1 and then back to 0 is verified.

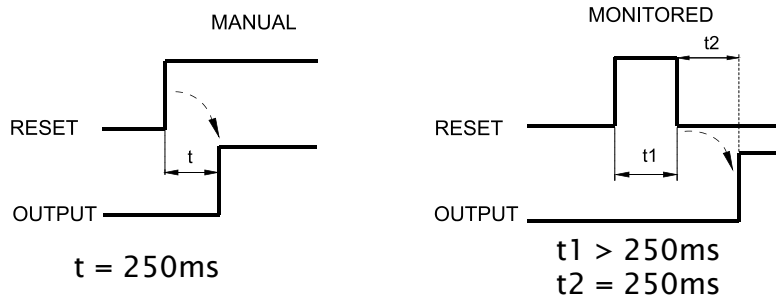

- ➔ **WARNING:** If the Manual Reset is active, a consecutive Input have to be used. Example: Input 1 is used for the functional block, then Input 2 have to be used for the Reset Input.

**Output test:** This is used to select which test output signals are to be sent to the sensor. This additional control permits detection and management of any short-circuits between the lines. To enable this control, the test output signals must be configured (amongst those available).

**Test at start-up:** If selected this enables the test at start-up of the sensor. This test is performed by occupying and clearing the area protected by the sensor to run a complete function test and enable the output. This test is only requested at machine start-up (when the unit is switched on).

**Filter (ms):** This is used to filter the signals coming from the sensor. The filter can be configured to between 3 and 250 ms and eliminates any bouncing on the contacts. The length of the filter affects the calculation of the unit's total response time.

**Enable Error Out:** If selected reports a fault detected by the function block.

**Item description:** This allows a description of the component's function to be entered. The text is displayed in the top part of the symbol.



## S-MAT (safety mat)

The S-MAT function block verifies the status of the inputs of a safety mat. If a person stands on the mat the output is 0 (FALSE). Otherwise, with the mat clear, the output is 1 (TRUE).

### Parameters

**Manual reset:** If selected this enables the request to reset each time the mobile guard/safety gate is activated. Otherwise, enabling of the output directly follows the input conditions.

There are two types of reset: Manual and Monitored. When Manual is selected the system only verifies the signal's transition from 0 to 1. If Monitored is selected the double transition from 0 to 1 and then back to 0 is verified.

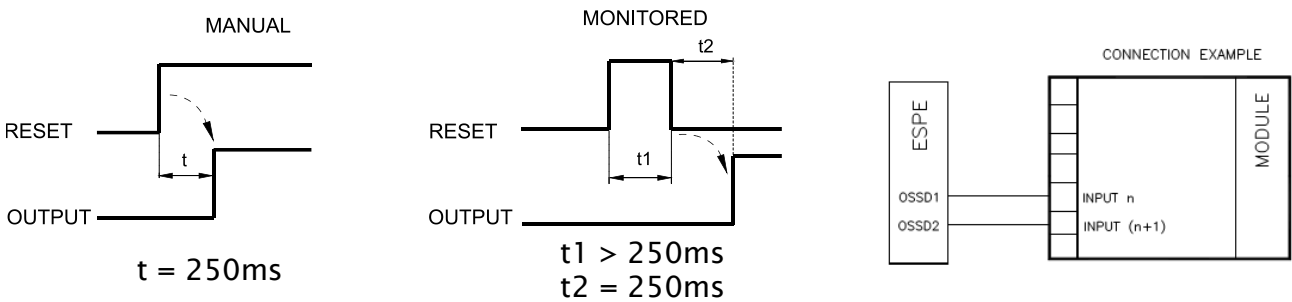
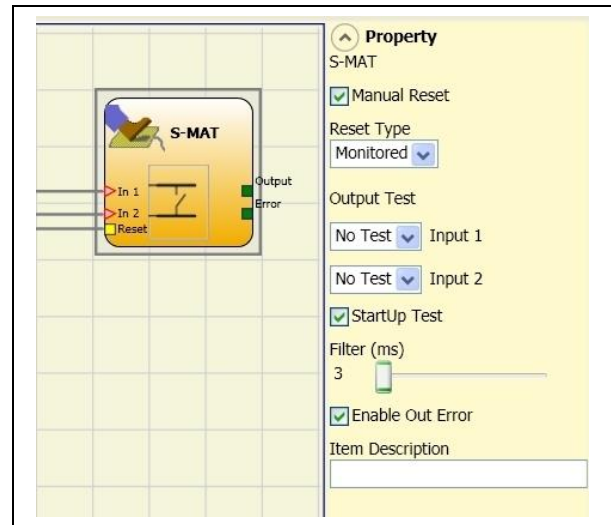

- ➔ If the Manual Reset is active, a consecutive Input have to be used. Example: Input 1 and Input 2 are used for the functional block, then Input 3 have to be used for the Reset Input.
- ➔ Two output test signals are mandatory. Each output OUT TEST can be connected to only one input S-MAT (it is not allowed parallel connection of 2 inputs).
- ➔ The function block S-MAT cannot be used with 2-wire components and termination resistance.

**Output test:** This is used to select which test output signals are to be sent to the s-mat contact. This additional control permits detection and management of any short-circuits between the lines. To enable this control, the test output signals must be configured (amongst those available). Test signals are mandatory.

**Test at start-up:** If selected this enables the test at start-up of the external component. This test is performed by pressing and releasing the safety mat to run a complete function test and enable the output. This test is only requested at machine start-up (when the unit is switched on).

**Filter (ms):** This is used to filter the signals coming from the external contacts. The filter can be configured to between 3 and 250 ms and eliminates any bouncing on the contacts. The length of the filter affects the calculation of the unit's total response time.

**Enable Error Out:** If selected reports a fault detected by the function block.

**Item description:** This allows a description of the component's function to be entered. The text is displayed in the top part of the symbol.

## SWITCH

SWITCH function block verifies the input status of a pushbutton or switch (NOT SAFETY SWITCHES). If the pushbutton is pressed the output is 1 (TRUE). Otherwise, the output is 0 (FALSE).

### Parameters

**Manual reset:** If selected this enables the request to reset each time the device is activated. Otherwise, enabling of the output directly follows the input conditions.

There are two types of reset: Manual and Monitored. When Manual is selected the system only verifies the signal's transition from 0 to 1. If Monitored is selected the double transition from 0 to 1 and then back to 0 is verified.

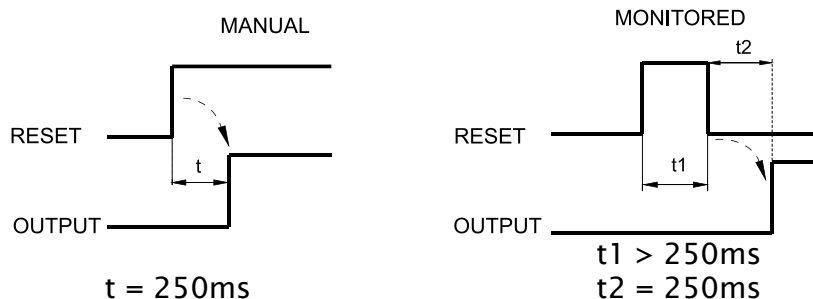
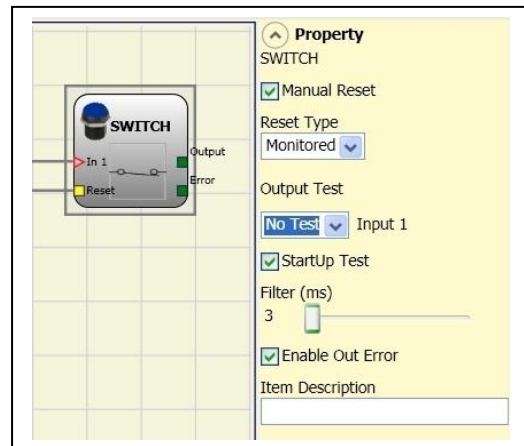

➔ **WARNING:** If the Manual Reset is active, a consecutive Input have to be used. Example: Input 1 is used for the functional block, then Input 2 have to be used for the Reset Input.

**Output test:** This is used to select which test output signals are to be sent to the switch. This additional control permits detection and management of any short-circuits between the lines. To enable this control, the test output signals must be configured (amongst those available).

**Test at start-up:** If selected this enables the test at start-up of the switch. This test is performed by opening and closing the switch contact to run a complete function test and enable the output. This test is only requested at machine start-up (when the unit is switched on).

**Filter (ms):** This is used to filter the signals coming from the switch. The filter can be configured to between 3 and 250ms and eliminates any bouncing on the contacts. The length of the filter affects the calculation of the unit's total response time.

**Enable Error Out:** If selected reports a fault detected by the function block.

**Item description:** This allows a description of the component's function to be entered. The text is displayed in the top part of the symbol.

## ENABLING GRIP SWITCH

The ENABLING GRIP functional block checks the status of the In<sub>x</sub> inputs of an enabling grip. If this is not gripped (position 1) or is gripped completely (position 3), the OUTPUT will be 0 (FALSE). If it is gripped to middle position (position 2), the OUTPUT will be 1 (TRUE). Refer to truth tables at the bottom of the page.

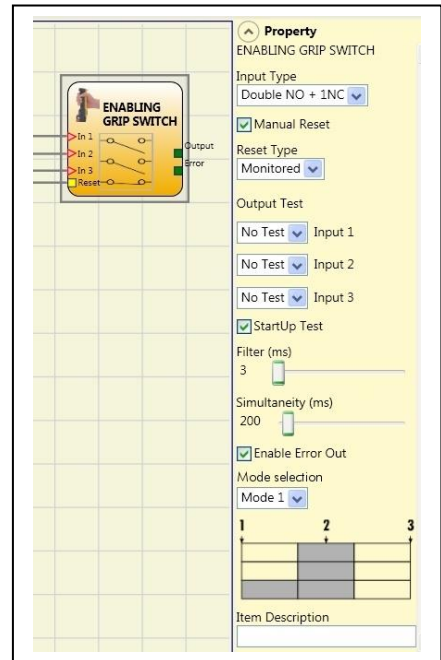

➔ The ENABLING GRIP functional block requires that the assigned module has a minimum Firmware version as Table below:

M1	MI8O2	MI8	MI16	MI12T8
1.0	0.4	0.4	0.4	0.0

### Parameters

*Type of inputs:*

- Double NO – Permits connection of an enabling grip with 2 NO contacts.
- Double NO+1NC – Permits connection of an enabling grip switch with 2 NO contacts + 1 NC contact.

*Test outputs:* Permits selection of the test output signals to be sent to the enabling grip. This additional control permits detection and management of any short-circuits between the lines. To enable this control, the test output signals must be configured (amongst those available).

*Power-on test:* If selected, enables the power-on test of the external component (Enabling Grip). To run the test, the device must be gripped and released to carry out a complete functional check and enable the Output terminal. This control is required only at machine start-up (power-on of the module).

*Simultaneity (ms):* always active. Determines the maximum permissible time (ms) between switching of the various signals from the external contacts of the device.

*Filter (ms):* Permits filtering of signals from the device control. This filter can be set to between 3 and 250ms and eliminates any rebounds on the contacts. The duration of the filter affects calculation of module total response time.

### Table mode 1 (device 2NO + 1NC)

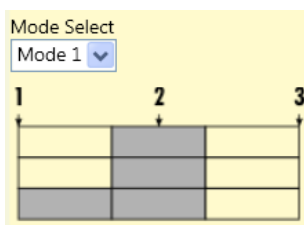

POSITION 1: enabling grip fully released  
 POSITION 2: enabling grip pressed to middle position  
 POSITION 3: enabling grip fully pressed

Input	Position		
	1	2	3
IN1	0	1	0
IN2	0	1	0
IN3	1	1	0
OUT	0	1	0

Table mode 1 (device 2NO + 1NC)

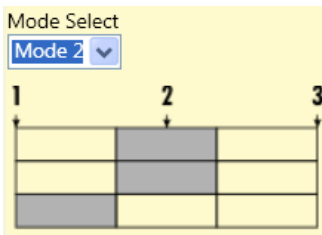

POSITION 1: enabling grip fully released  
 POSITION 2: enabling grip pressed to middle position  
 POSITION 3: enabling grip fully pressed

Input	Position		
	1	Input	1
IN1	0	1	0
IN2	0	1	0
IN3	1	0	0
OUT	0	1	0

*Enable Error Out:* If selected reports a fault detected by the function block.

*Item description:* Permits insertion of a descriptive text of the function of the component. This text will be displayed in the top part of the symbol.

TESTABLE SAFETY DEVICE

The TESTABLE SAFETY DEVICE functional block checks the status of the Inx inputs of a single or double safety sensor, both NO and NC. Refer to the tables below to check type of sensor and behaviour.

(single NC)



IN1	OUT
0	0
1	1

(single NO)

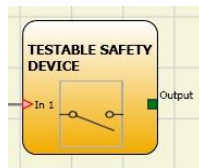

IN1	OUT
0	0
1	1

(double NC)

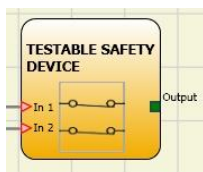

IN1	IN2	OUT	Simultaneity error *
0	0	0	-
0	1	0	X
1	0	0	X
1	1	1	-

(double NC-NO)



IN1	IN2	OUT	Simultaneity error *
0	0	0	X
0	1	0	-
1	0	1	-
1	1	0	X

\* Simultaneity error = the maximum time between switching of the single contacts has been exceeded.

Parameters

*Manual Reset:* If selected, enables the reset request after each activation of the device. Otherwise, enabling of the output follows directly the conditions of the inputs. Reset may be of two types: Manual and Monitored. Selecting the Manual option, only transition of the signal from 0 to 1 is checked. If Monitored is selected, double transition from 0 to 1 and return to 0 is checked.

english

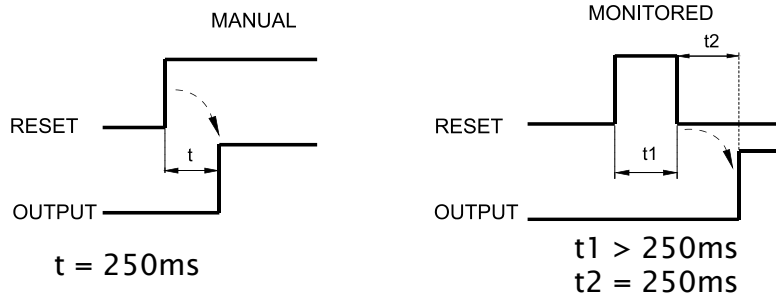

➔ **WARNING:** if Reset is enabled, the input consecutive to those used by the functional block must be used. For example: If inputs 1 and 2 are used for the functional block, input 3 must be used for Reset.

*Power-on test:* If selected, enables the power-on test of the device. This test requires activation and de-activation of the device in order to run a complete functional check and enable the Output terminal. This test is required only at machine start-up (power-on of the module).

*Filter (ms):* Permits filtering of signals from the device. This filter can be set to between 3 and 250 ms and eliminates any rebounds on the contacts. The duration of the filter affects calculation of module total response time.

*With simultaneity:* If selected, activates control of simultaneity between switching of signals from the device.

*Simultaneity (ms):* Is active only if the previous parameter is enabled. Determines the maximum permissible time (msec) between switching of two different signals from the sensor.

*Enable Error Out:* If selected reports a fault detected by the function block.

*Item description:* Permits insertion of a descriptive text of the function of the component. This text will be displayed in the top part of the symbol.

## SOLID STATE DEVICE

The SOLID STATE DEVICE functional block checks the status of the Inx inputs. If the inputs are at 24VDC, the Output will be 1 (TRUE), otherwise the OUTPUT will be 0 (FALSE).

### Parameters

*Manual Reset:* If selected, enables the reset request after each safety function activation. Otherwise, enabling of the output follows directly the conditions of the inputs. Reset may be of two types: Manual and Monitored. Selecting the Manual option, only transition of the signal from 0 to 1 is checked.

If Monitored is selected, double transition from 0 to 1 and return to 0 is checked.

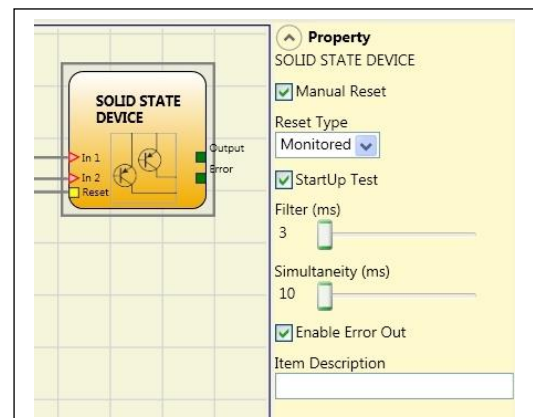

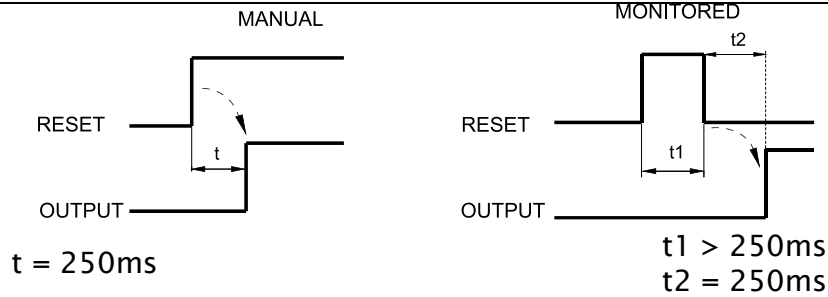

**WARNING:** if Reset is enabled, the input consecutive to those used by the functional block must be used. For example: if inputs 1 and 2 are used for the functional block, input 3 must be used for Reset.

**Power-on test:** If selected, enables the power-on test of the safety device. This test requires activation and de-activation of the device in order to run a complete functional check and enable the Output terminal. This test is required only at machine start-up (power-on of the module)

**Filter (ms):** Permits filtering of signals from the safety device. This filter can be set to between 3 and 250 ms and eliminates any rebounds on the contacts. The duration of the filter affects calculation of module total response time.

**Simultaneity (ms):** always active. Determines the maximum permissible time (msec) between switching of the various signals from the external contacts of the device.

**Enable Error Out:** If selected reports a fault detected by the function block.

**Item description:** Permits insertion of a descriptive text of the function of the component. This text will be displayed in the top part of the symbol.

## FIELDBUS INPUT

Element that permits insertion of a non-safety input whose status is modified via the fieldbus.

It is possible to insert a maximum of 32 virtual inputs with M1S and MBx fw  $\geq 2.0$  and 8 with M1 or MBx fw  $< 2.0$ .

The bit on which status is to be modified must be selected for each.

On the fieldbus the states are represented with 4 bytes with M1S and 1 byte with M1.

(For more detailed information, consult the fieldbus manual on the MSD CD-ROM).

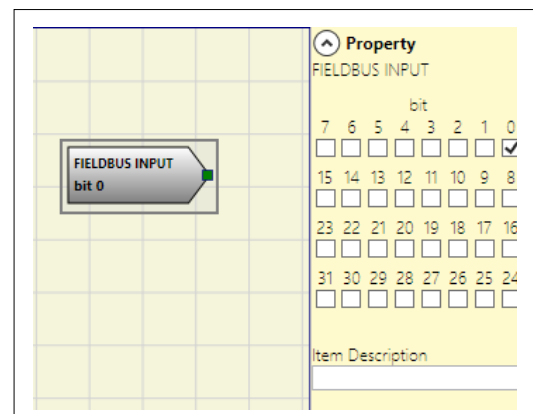

**WARNING:** the FIELDBUS INPUT is NOT a safety input.

## LL0-LL1

These allow a predefined logical level to be entered on a component's input.

LL0 -> logical level 0

LL1 -> logical level 1

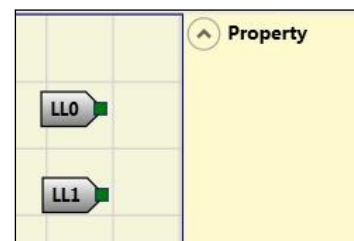

**⚡ IMPORTANT:** LL0 and LL1 cannot be used to disable the logical ports in the diagram.

## COMMENTS

This allows a description to be entered and placed in any point of the diagram.

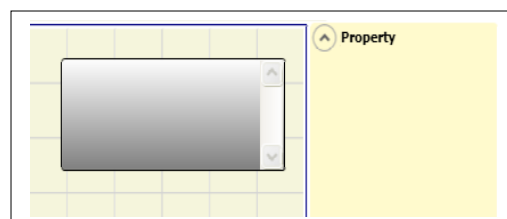

## TITLE

Automatically adds the name of the manufacturer, the designer, the project name and the CRC.

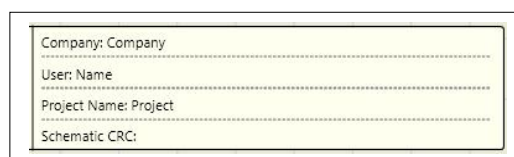

## SPEED CONTROL TYPE FUNCTION BLOCKS

### Warning concerning safety

- ⚠ An external error or malfunction deriving from encoder/proximity or its wiring, does not necessarily involve a change of safety status of the normal output (i.e. “Zero”) of the function block. Failures or malfunctions of encoder/proximity switch or its wiring are then recognized by the module, managed and specified via the diagnostic bit on every function block (“**Enable Error Out**”).
- ⚠ To ensure the safety features the diagnostic bit has to be used in the configuration program created by the user to cause a possible deactivation of the outputs if the axis is working. In absence of encoder/proximity external anomalies, **Error** bit will be equal to 0 (zero).
- ⚠ In presence of encoder/proximity external anomalies, error\_out bit will be equal to 1 (one):
  - Absence of encoder or proximity.
  - Absence of one or more wiring from encoder/proximity.
  - Absence of encoder power supply (only model with TTL external power supply).
  - Error of congruence frequencies between signals from encoder/proximity.
  - Phase error between signals from the encoder or duty cycle error of a single phase.

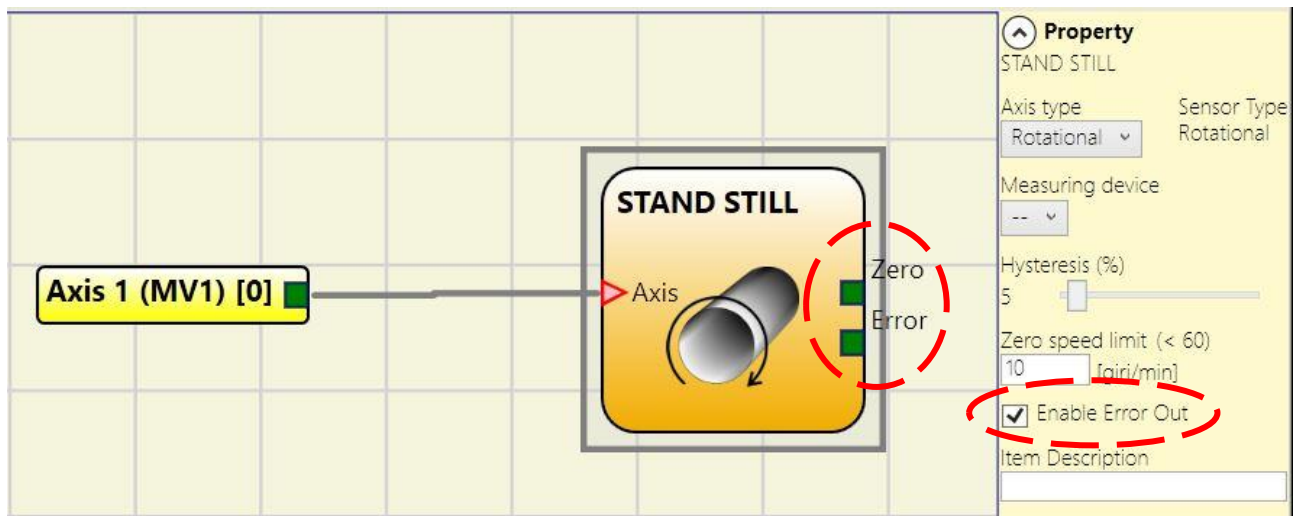

Figure 67 – Example of speed control functional block with Error Out enabled



## SPEED CONTROL

The **Speed Control** function block monitors the speed of a device generating an output 0 (FALSE) when the measured speed exceeds a predetermined threshold. In the case in which the speed is below the predetermined threshold the output will be 1 (TRUE).

### Parameters

**Axis type:** It defines the type of axis controlled by the device. It will be Linear in the case of a translation and will be Rotary in the case of motion around an axis.

**Sensor Type:** In the event that the previous parameter is Linear, the Sensor Type defines the type of sensor connected to the module inputs. It can be Rotary (e.g. shaft encoder) or Linear (e.g. optical array). This choice allows to define the following parameters.

**Measuring device:** It defines the type of sensor(s) used. The possible choices are:

- Encoder
- Proximity
- Encoder+Proximity
- Proximity1+ Proximity2
- Encoder1+ Encoder2

**Enable direction:** Enabling this parameter, the DIR output is enabled on the function block. This output will be 1 (TRUE) when the axis rotates Counterclockwise and will be 0 (FALSE) when the axis rotates Clockwise

**Direction decision:** It defines the direction of rotation for which the set thresholds are made active. The possible choices are:

- Bidirectional
- Clockwise
- Counterclockwise

If Bidirectional is selected, the excess of the set threshold is detected whether the axis rotates clockwise or counterclockwise. Selecting Clockwise or Counterclockwise, this is detected only when the axis rotates in the selected direction.

**Threshold number:** It allows you to enter the number of thresholds for the maximum value of speed. Changing this value will increase/decrease the number of thresholds that can be entered from a minimum of 1 to a maximum of 8 with M1 fw >= 4.0, M1S fw >=5.1 and MVx fw >= 2.0 and 4 with M1 fw <4.0 or or M1S< 5.1 or MVx fw < 2.0. In the case of thresholds greater than 1, the input pins for the selection of the specific threshold will appear in the lower part of the function block.

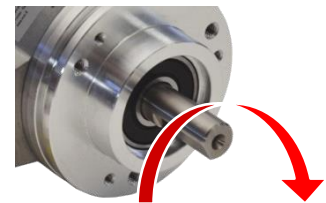
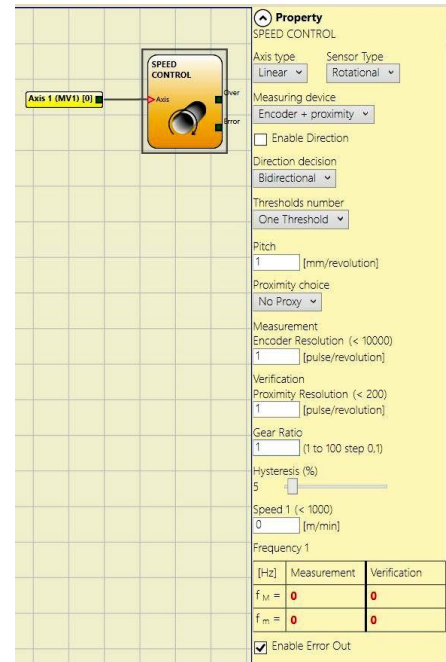

Example of CLOCKWISE axis rotation

2 threshold settings

In1	Threshold no.
0	Speed 1
1	Speed 2

Up to 4 threshold settings

In2	In1	Threshold no.
0	0	Speed 1
0	1	Speed 2
1	0	Speed 3
1	1	Speed 4

Up to 8 threshold settings

In3	In2	In1	Threshold no.
0	0	0	Speed 1
0	0	1	Speed 2
0	1	0	Speed 3
0	1	1	Speed 4
1	0	0	Speed 5
1	0	1	Speed 6
1	1	0	Speed 7
1	1	1	Speed 8

**Pitch:** If the Axis Type chosen was linear, this field allows you to enter the sensor pitch to obtain a conversion between sensor revolutions and distance travelled.

**Proximity choice:** It allows you to choose the type of proximity sensor from PNP, NPN, Normally Open (NA) and Normally Closed (NC), with 3 or 4 wires.

(In order to ensure a Performance Level = PLe use a proximity switch type PNP NO: ref. "Interleaved proximity -> page 33).

No Proxy
PNP 3-wire NC
PNP 3-wire NO
NPN 3-wire NO
NPN 3-wire NC
PNP 4-wire NC/NO
NPN 4-wire NC/NO
PNP/NPN 4-wire NC/NC
PNP/NPN 4-wire NO/NO

**Measurement:** Enter in this field the number of pulses/revolution (in the case of rotary sensor) or µm/pulse (linear sensor) relating to the sensor used

**Verification:** Enter in this field the number of pulses/revolution (in the case of rotary sensor) or µm/pulse (linear sensor) relating to the second sensor used.

**Gear Ratio:** This parameter is active if there are two sensors on the selected axis. This parameter allows you to enter the ratio between the two sensors. If both sensors are on the same moving parts, the ratio will be 1 otherwise the number corresponding to the report must be entered. E.g. there are an encoder and a proximity switch, and the latter is on a moving part that (due to a gear reduction ratio) rotates at twice the speed of the encoder. Therefore, this value must be set at 2.

**Hysteresis (%):** It represents the percentage hysteresis value below which the speed change is filtered. Enter a value other than 1 to avoid continuous switching as the input changes.

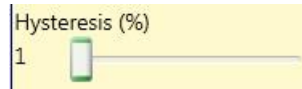

**Speed 1...8:** Enter in this field the maximum speed value above which the function block output (OVER) will be 0 (FALSE). If the measured speed is less than the set value, the function block output (OVER) will be 1 (TRUE). If M1 fw >= 4.0, M1S fw >= 5.1 and MVx fw >= 2.0 it's possible to enter the speed value with the decimal point.

**Frequency:** It shows the maximum calculated frequency values fM and fm (decreased by the hysteresis set). If the displayed value is GREEN, the calculation of frequency gave a positive result.

If the displayed value is RED, it is necessary to change the parameters given in the following formulas.

Proximity choice:

**KEY:**

f = frequency  
Rpm = rotational speed  
Resolution = measurement  
Speed = linear speed  
Pitch = sensor pitch

1. Rotary axis, rotary sensor. The frequency obtained is:

$$f[\text{Hz}] = \frac{\text{rpm}[\text{rev}/\text{min}]}{60} * \text{Resolution}[\text{pulses}/\text{rev}]$$

2. Linear axis, rotary sensor. The frequency obtained is:

$$f[\text{Hz}] = \frac{\text{speed}[\text{m}/\text{min}] * 1000}{60 * \text{pitch}[\text{mm}/\text{rev}]} * \text{Resolution}[\text{pulses}/\text{rev}]$$

3. Linear axis, linear sensor. The frequency obtained is:

$$f[\text{Hz}] = \frac{\text{speed}[\text{mm}/\text{s}] * 1000}{\text{Resolution}[\mu\text{m}/\text{pulse}]}$$

4. Hysteresis. To be changed only if: fM=green; fm=red

## WINDOW SPEED CONTROL

The **Window Speed Control** function block monitors the speed of a device, generating the Zero to 1 (TRUE) output when the speed is within a prefixed range.

### Parameters

**Axis type:** It defines the type of axis controlled by the device. It will be Linear in the case of a translation and will be Rotary in the case of motion around an axis.

**Sensor Type:** In the event that the previous parameter is Linear, the Sensor Type defines the type of sensor connected to the module inputs. It can be Rotary (e.g. shaft encoder) or Linear (e.g. optical array). This choice allows to define the following parameters.

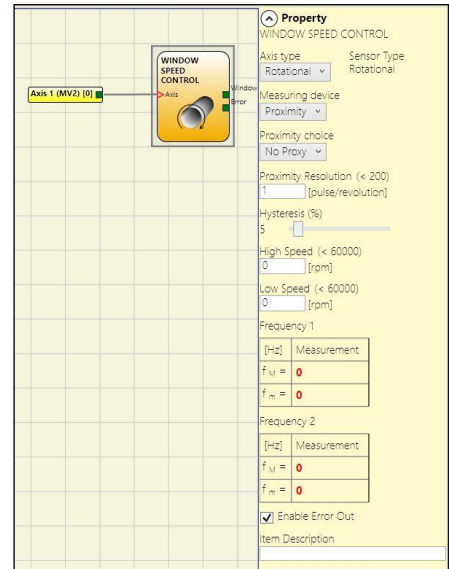

**Measuring device:** It defines the type of sensor(s) used. The possible choices are:

- Encoder
- Proximity
- Encoder+Proximity
- Proximity1+ Proximity2
- Encoder1+ Encoder2

**Pitch:** If the Axis Type chosen was linear, this field allows you to enter the sensor pitch to obtain a conversion between sensor revolutions and distance travelled.

**Proximity choice:** It allows you to choose the type of proximity sensor from PNP, NPN, Normally Open (NO) and Normally Closed (NC), with 3 or 4 wires.

*(In order to ensure a Performance Level = PLe use a proximity switch type PNP NO: ref. "Interleaved proximity -> page 33).*

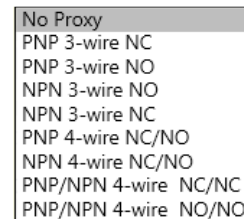

Proximity choice

**Measurement:** Enter in this field the number of pulses/revolution (in the case of rotary sensor) or  $\mu\text{m}/\text{pulse}$  (linear sensor) relating to the sensor used.

**Verification:** Enter in this field the number of pulses/revolution (in the case of rotary sensor) or  $\mu\text{m}/\text{pulse}$  (linear sensor) relating to the second sensor used.

**Gear Ratio:** This parameter is active if there are two sensors on the selected axis. This parameter allows you to enter the ratio between the two sensors. If both sensors are on the same moving parts, the ratio will be 1 otherwise the number corresponding to the report must be entered. E.g. there are an encoder and a proximity switch, and the latter is on a moving part that (due to a gear reduction ratio) rotates at twice the speed of the encoder. Therefore, this value must be set at 2.

**Hysteresis (%):** It represents the percentage hysteresis value below which the speed change is filtered. Enter a value other than 1 to avoid continuous switching as the input changes.

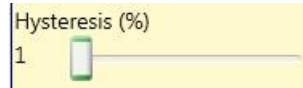

**High speed:**

Enter in this field the maximum speed value above which the output of the function block (WINDOW) will be 0 (FALSE). If the measured speed is less than the set value, the output (WINDOW) of the function block will be 1 (TRUE). If M1 fw >= 4.0 and MVx fw >= 2.0 it's possible to enter the speed value with the decimal point (not with M1S).

**Low speed:**

Enter in this field the minimum speed value below which the output of the function block (WINDOW) will be 0 (FALSE). If the measured speed is more than the set value, the output (WINDOW) of the function block will be 1 (TRUE). If M1 fw >= 4.0 and MVx fw >= 2.0 it's possible to enter the speed value with the decimal point (not with M1S).

**Frequency:** It shows the maximum calculated frequency values fM and fm (decreased by the hysteresis set). If the displayed value is GREEN, the calculation of frequency gave a positive result.

If the displayed value is RED, it is necessary to change the parameters given in the following formulas.

1. Rotary axis, rotary sensor. The frequency obtained is:

$$f[\text{Hz}] = \frac{\text{rpm}[\text{rev}/\text{min}]}{60} * \text{Resolution}[\text{pulses}/\text{rev}]$$

2. Linear axis, rotary sensor. The frequency obtained is:

$$f[\text{Hz}] = \frac{\text{speed}[\text{m}/\text{min}] * 1000}{60 * \text{pitch}[\text{mm}/\text{rev}]} * \text{Resolution}[\text{pulses}/\text{rev}]$$

3. Linear axis, linear sensor. The frequency obtained is:

$$f[\text{Hz}] = \frac{\text{speed}[\text{mm}/\text{s}] * 1000}{\text{Resolution}[\mu\text{m}/\text{pulse}]}$$

4. Hysteresis. To be changed only if: fM=green; fm=red

**KEY:**

f = frequency  
Rpm = rotational speed  
Resolution = measurement  
Speed = linear speed  
Pitch = sensor pitch

## STAND STILL

The **StandStill** function block monitors the speed of a device, generating the Zero to 1 (TRUE) output when the speed is lower than a selected value.

### Parameters

**Axis type:** It defines the type of axis controlled by the device. It will be Linear in the case of a translation and will be Rotary in the case of motion around an axis.

**Sensor Type:** In the event that the previous parameter is Linear, the Sensor Type defines the type of sensor connected to the module inputs. It can be Rotary (e.g. shaft encoder) or Linear (e.g. optical array). This choice allows to define the following parameters.

**Measuring device:** It defines the type of sensor(s) used. The possible choices are:

- Encoder
- Proximity
- Encoder+Proximity
- Proximity1 + Proximity2
- Encoder1 + Encoder2

**Pitch:** If the Axis Type chosen was linear, this field allows you to enter the sensor pitch to obtain a conversion between sensor revolutions and distance travelled.

**Proximity choice:** It allows you to choose the type of proximity sensor from PNP, NPN, Normally Open (NA) and Normally Closed (NC), with 3 or 4 wires.

*(In order to ensure a Performance Level = PLe use a proximity switch type PNP NO: ref. "Interleaved proximity -> page 25).*

**Measurement:** Enter in this field the number of pulses/revolution (in the case of rotary sensor) or  $\mu\text{m}/\text{pulse}$  (linear sensor) relating to the sensor used

**Verification:** Enter in this field the number of pulses/revolution (in the case of rotary sensor) or  $\mu\text{m}/\text{pulse}$  (linear sensor) relating to the second sensor used.

**Gear Ratio:** This parameter is active if there are two sensors on the selected axis. This parameter allows you to enter the ratio between the two sensors. If both sensors are on the same moving parts, the ratio will be 1 otherwise the number corresponding to the report must be entered. E.g. there are an encoder and a proximity switch, and the latter is on a moving part that (due to a gear reduction ratio) rotates at twice the speed of the encoder. Therefore, this value must be set at 2.

**Hysteresis (%):** It represents the percentage hysteresis value below which the speed change is filtered. Enter a value other than 1 to avoid continuous switching as the input changes.

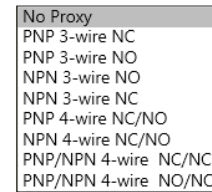
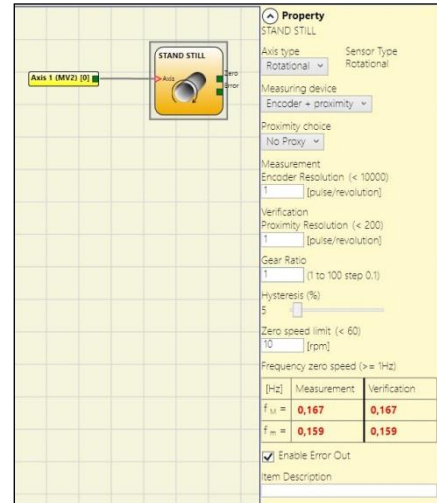

Proximity choice

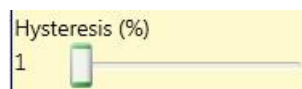

**Zero speed limit:**

Enter in this field the maximum speed value above which the output of the function block (ZERO) will be 0 (FALSE). If the measured speed is less than the set value, the output (ZERO) of the function block will be 1 (TRUE).

**Frequency zero speed:** It shows the maximum calculated frequency values  $f_M$  and  $f_m$  (decreased by the hysteresis set). If the displayed value is GREEN, the calculation of frequency gave a positive result.

If the displayed value is RED, it is necessary to change the parameters given in the following formulas.

1. Rotary axis, rotary sensor. The frequency obtained is:

$$f[\text{Hz}] = \frac{\text{rpm}[\text{rev}/\text{min}]}{60} * \text{Resolution}[\text{pulses}/\text{rev}]$$

2. Linear axis, rotary sensor. The frequency obtained is:

$$f[\text{Hz}] = \frac{\text{speed}[\text{m}/\text{min}] * 1000}{60 * \text{pitch}[\text{mm}/\text{rev}]} * \text{Resolution}[\text{pulses}/\text{rev}]$$

3. Linear axis, linear sensor. The frequency obtained is:

$$f[\text{Hz}] = \frac{\text{speed}[\text{mm}/\text{s}] * 1000}{\text{Resolution}[\mu\text{m}/\text{pulse}]}$$

4. Hysteresis. To be changed only if:  $f_M$ =green;  $f_m$ =red

**KEY:**

*f* = frequency  
*Rpm* = rotational speed  
*Resolution* = measurement  
*Speed* = linear speed  
*Pitch* = sensor pitch

## STAND STILL AND SPEED CONTROL

The **StandStill and Speed Control** function block monitors the speed of a device, generating the Zero to 1 (TRUE) output when the speed is lower than a selected value. In addition, it generates the Over = 0 (FALSE) output if the measured speed exceeds a predetermined threshold.

### Parameters

**Axis type:** It defines the type of axis controlled by the device. It will be Linear in the case of a translation and will be Rotary in the case of motion around an axis.

**Sensor Type:** In the event that the previous parameter is Linear, the Sensor Type defines the type of sensor connected to the module inputs. It can be Rotary (e.g. shaft encoder) or Linear (e.g. optical array). This choice allows to define the following parameters.

**Measuring device:** It defines the type of sensor(s) used. The possible choices are:

- Encoder
- Proximity
- Encoder+Proximity
- Proximity1+ Proximity2
- Encoder1+ Encoder2

**Enable direction:** Enabling this parameter, the DIR output is enabled on the function block. This output will be 1 (TRUE) when the axis rotates Counterclockwise and will be 0 (FALSE) when the axis rotates Clockwise.

**Direction decision:** It defines the direction of rotation for which the set thresholds are made active. The possible choices are:

- Bidirectional
- Clockwise
- Counterclockwise

If Bidirectional is selected, the excess of the set threshold is detected whether the axis rotates clockwise or counterclockwise. Selecting Clockwise or Counterclockwise, this is detected only when the axis rotates in the selected direction.

**Threshold number:** It allows you to enter the number of thresholds for the maximum value of speed. Changing this value will increase/decrease the number of thresholds that can be entered from a minimum of 1 to a maximum of 8 with M1 fw  $\geq 4.0$ , M1S fw  $\geq 5.1$  and MVx fw  $\geq 2.0$  and 4 with M1 fw  $< 4.0$  or o M1S fw  $< 5.1$  or MVx fw  $< 2.0$ . In the case of thresholds greater than 1, the input pins for the selection of the specific threshold will appear in the lower part of the function block.

Up to 8 threshold settings

In3	In2	In1	Threshold no.
0	0	0	Speed 1
0	0	1	Speed 2
0	1	0	Speed 3
0	1	1	Speed 4
1	0	0	Speed 5
1	0	1	Speed 6
1	1	0	Speed 7
1	1	1	Speed 8

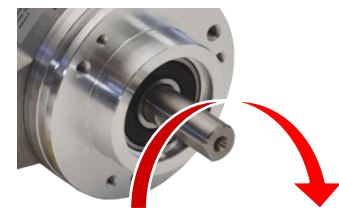
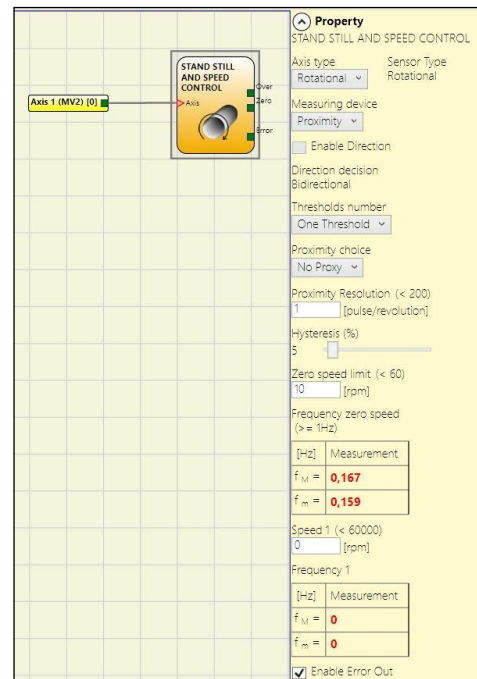

Example of CLOCKWISE axis rotation

2 threshold settings

In1	Threshold no.
0	Speed 1
1	Speed 2

Up to 4 threshold settings

In2	In1	Threshold no.
0	0	Speed 1
0	1	Speed 2
1	0	Speed 3
1	1	Speed 4

**Pitch:** If the Axis Type chosen was linear, this field allows you to enter the sensor pitch to obtain a conversion between sensor revolutions and distance travelled.

**Proximity choice:** It allows you to choose the type of proximity sensor from PNP, NPN, Normally Open (NA) and Normally Closed (NC), with 3 or 4 wires.

- No Proxy
- PNP 3-wire NC
- PNP 3-wire NO
- NPN 3-wire NO
- NPN 3-wire NC
- PNP 4-wire NC/NO
- NPN 4-wire NC/NO
- PNP/NPN 4-wire NC/NC
- PNP/NPN 4-wire NO/NO

(In order to ensure a Performance Level = PLe use a proximity switch type PNP NO: ref. "Interleaved proximity -> page 33).

Proximity choice:

**Measurement:** Enter in this field the number of pulses/revolution (in the case of rotary sensor) or  $\mu\text{m}/\text{pulse}$  (linear sensor) relating to the sensor used

**Verification:** Enter in this field the number of pulses/revolution (in the case of rotary sensor) or  $\mu\text{m}/\text{pulse}$  (linear sensor) relating to the second sensor used.

**Gear Ratio:** This parameter is active if there are two sensors on the selected axis. This parameter allows you to enter the ratio between the two sensors. If both sensors are on the same moving parts, the ratio will be 1 otherwise the number corresponding to the report must be entered. E.g. there are an encoder and a proximity switch, and the latter is on a moving part that (due to a gear reduction ratio) rotates at twice the speed of the encoder. Therefore, this value must be set at 2.

**Hysteresis (%):** It represents the percentage hysteresis value below which the speed change is filtered. Enter a value other than 1 to avoid continuous switching as the input changes.

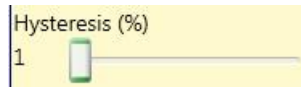

**Zero speed limit:**

Enter in this field the maximum speed value above which the output of the function block (ZERO) will be 0 (FALSE). If the measured speed is less than the set value, the output (ZERO) of the function block will be 1 (TRUE).

**Speed 1...8:** Enter in this field the maximum speed value above which the function block output (OVER) will be 0 (FALSE). If the measured speed is less than the set value, the function block output (OVER) will be 1 (TRUE). ). If M1 fw  $\geq 4.0$ , M1S fw  $\geq 5.1$  and MVx fw  $\geq 2.0$  it's possible to enter the speed value with the decimal point.



**Frequency zero speed/Frequency1/ Frequency2:** It shows the maximum calculated frequency values fM and fm (decreased by the hysteresis set). If the displayed value is GREEN, the calculation of frequency gave a positive result. If the displayed value is RED, it is necessary to change the parameters given in the following formulas.

1. Rotary axis, rotary sensor. The frequency obtained is:

$$f[\text{Hz}] = \frac{\text{rpm}[\text{rev}/\text{min}]}{60} * \text{Resolution}[\text{pulses}/\text{rev}]$$

2. Linear axis, rotary sensor. The frequency obtained is:

$$f[\text{Hz}] = \frac{\text{speed}[\text{m}/\text{min}] * 1000}{60 * \text{pitch}[\text{mm}/\text{rev}]} * \text{Resolution}[\text{pulses}/\text{rev}]$$

3. Linear axis, linear sensor. The frequency obtained is:

$$f[\text{Hz}] = \frac{\text{speed}[\text{mm}/\text{s}] * 1000}{\text{Resolution}[\mu\text{m}/\text{pulse}]}$$

4. Hysteresis. To be changed only if: fM=green; fm=red

**KEY:**

*f = frequency*  
*Rpm = rotational speed*  
*Resolution = measurement*  
*Speed = linear speed*  
*Pitch = sensor pitch*

## ANALOG INPUT TYPE FUNCTION BLOCKS

### ANALOG INPUT (4 inputs each MA4 module)

The functional block “Analog Input” allows the configuration of the type of analog sensor that will be used (current or voltage) together with the parameters that will set the acquisition. It allows also the configuration of two simple threshold comparators or one window comparator.

Input Voltage channel

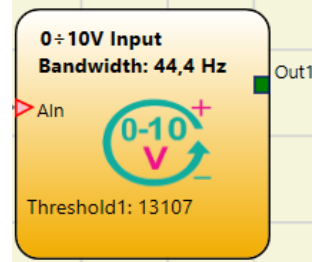

Input Current channel

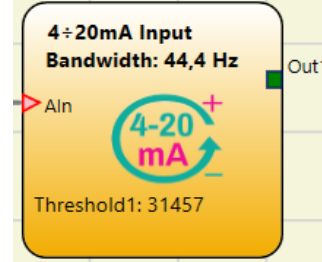

### Parameters

#### Parameters list

- Input type
  - Single
  - Redundant
    - Sensors coherence
    - Incoherence calculation mode
- Measurement unit
- Scale: minimum value
- Scale: maximum value
- 0÷20 mA Configuration
- 0÷10 V Input
- Window comparator
- Enable threshold 1
- Enable threshold 2
- Hysteresis
- Sample per second
- Current limit: minimum current
- Current limit: maximum current
- Sensor anomaly: measure saturated at 0 mA or 25 mA
- Analog Output
- Enable Error Out

Input Type	
Single	
<b>Measurement unit</b>	
c	
<b>Scale</b>	
4 mA:	0 c
20 mA:	100 c
Slope:	6,25 c/mA
Offset:	-25 c
<input type="checkbox"/> 0+20mA Configuration <input type="checkbox"/> 0+10V Input <input type="checkbox"/> Window comparator <input checked="" type="checkbox"/> Enable threshold1 Threshold1 50 c 49,9 c <input type="checkbox"/> Enable threshold2 Hysteresis [0,1÷6550,0] 0,1 c Samples per second [2,5÷4000] 100	
<b>Current limits</b>	
Minimum current [2,5÷3,9mA]	
3,8 mA	
Maximum current [20,1÷23,0mA]	
21 mA	
<b>Sensor anomaly</b>	
<input type="radio"/> Saturated 0mA <input checked="" type="radio"/> Saturated 25mA	
<input type="checkbox"/> Analog Output <input type="checkbox"/> Enable Error Out	
Item Description	

- ⚠ In the event that the wrong parameters are attributed (eg. scale values not corresponding to those used by sensor), the functionality of the MA4 module is compromised.
- ⚠ Perform a complete system TEST (see "TESTING the system").

Detailed description

---

Input type

---

It defines the inputs type of the MA4 module channels described below.

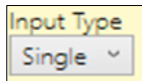

**Single**

---

A single sensor is connected to one channel from 1 to 4.

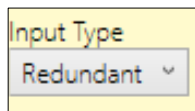
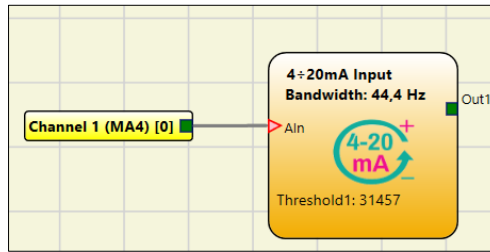

**Redundant**

---

A pair of sensors is connected to two adjacent channels (1-2 or 3-4). The sensor pair readings are processed by a single analog block.

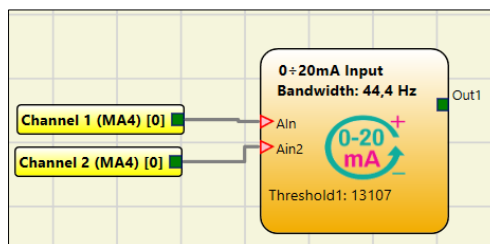

In the table below are summarized the channels allowable connections (the Not-connected cases are excluded on purpose).

Channel	Ch. 1	Ch. 2	Ch. 3	Ch. 4
Input Type	Single	Single	Single	Single
	Redundant	Redundant	Single	Single
	Single	Single	Redundant	Redundant

## Redundant connection menù

In case of Redundant connection, two further selection menus will be enabled:

1. Sensors coherence
2. Inconsistency calculating method

**Sensors coherence**

Allowed error  
± 0,1÷100,0 [Kg]  
   Kg

Error tolerance time [0,1÷2,5s]  
   s

**Incoherence calculation mode**

Equal sensors  
 Different sensors

**Scale**

0 mA (0V):	<input type="text" value="0"/>	Kg
20mA (10V):	<input type="text" value="0"/>	Kg
Slope	<input type="text" value="0"/>	Kg/V
Offset	<input type="text" value="0"/>	Kg

### Sensors coherence

**Sensors coherence**

Allowed error  
± 0,1÷100,0 [Kg]  
   Kg

Error tolerance time [0,1÷2,5s]  
   s

The redundant configuration involves the use of two sensors that, even if identical, will never provide the same reading (by the AD converter) for the same measurement.

For this reason, the following parameters have been introduced in the "Coherence Sensors" menu:

- *Allowed error*: it allows to define the tolerable deviation between the measurements of the two sensors in engineering units.
- *Error tolerance time*: maximum time to exceed the gap in seconds.

The meaning of the parameters explained above is explained below.

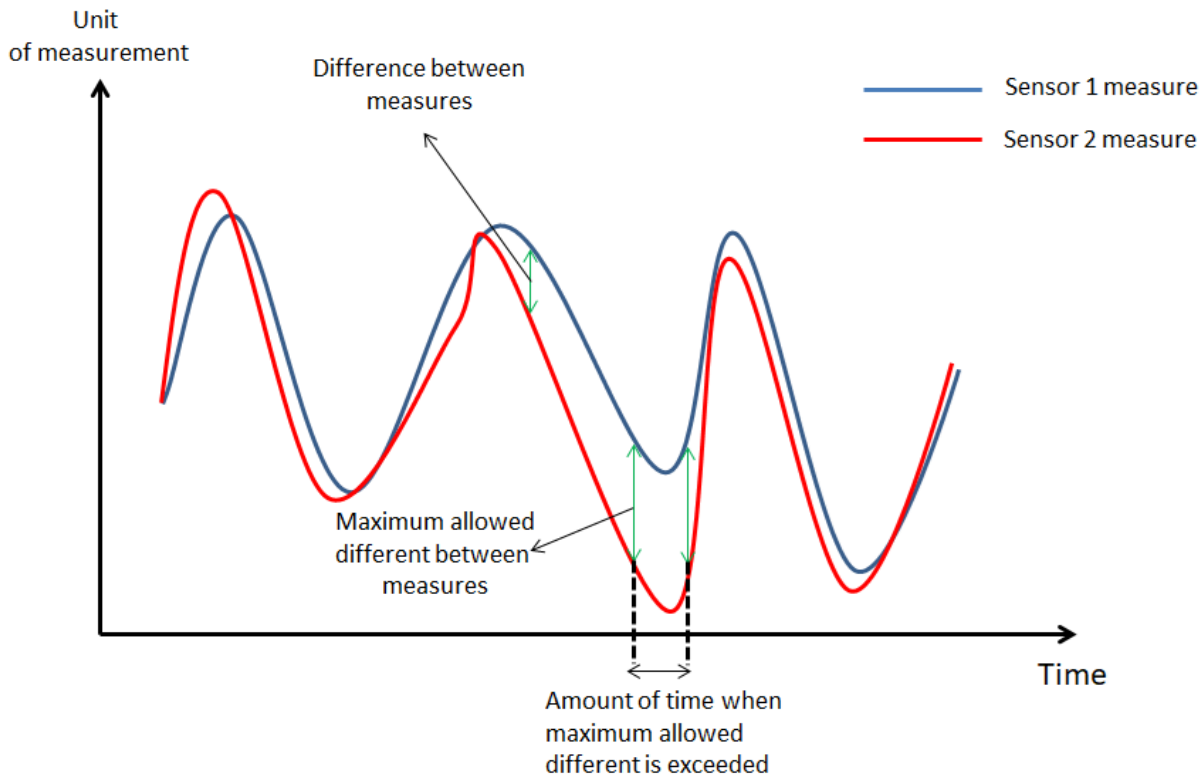

*Incoherence calculation mode*

Incoherence calculation mode		
<input type="radio"/>	Equal sensors	
<input checked="" type="radio"/>	Different sensors	
Scale		
0 mA (0V):	<input type="text" value="0"/>	Kg
20mA (10V):	<input type="text" value="0"/>	Kg
Slope	<input type="text" value="0"/>	Kg/V
Offset	<input type="text" value="0"/>	Kg

The sensors used in the redundant configuration provide the same reading (by the AD converter) in engineering unit but it is not sure that they have the same measurement scale.

The parameters that can be selected in the menu "Calculation of inconsistency" allow the operator to define whether the sensors are the same or different.

Same sensors

Incoherence calculation mode	
<input checked="" type="radio"/>	Equal sensors
<input type="radio"/>	Different sensors

When this option is selected the sensors are identical and there are no other parameters to configure.

The following figure shows two sensors with the same characteristics.

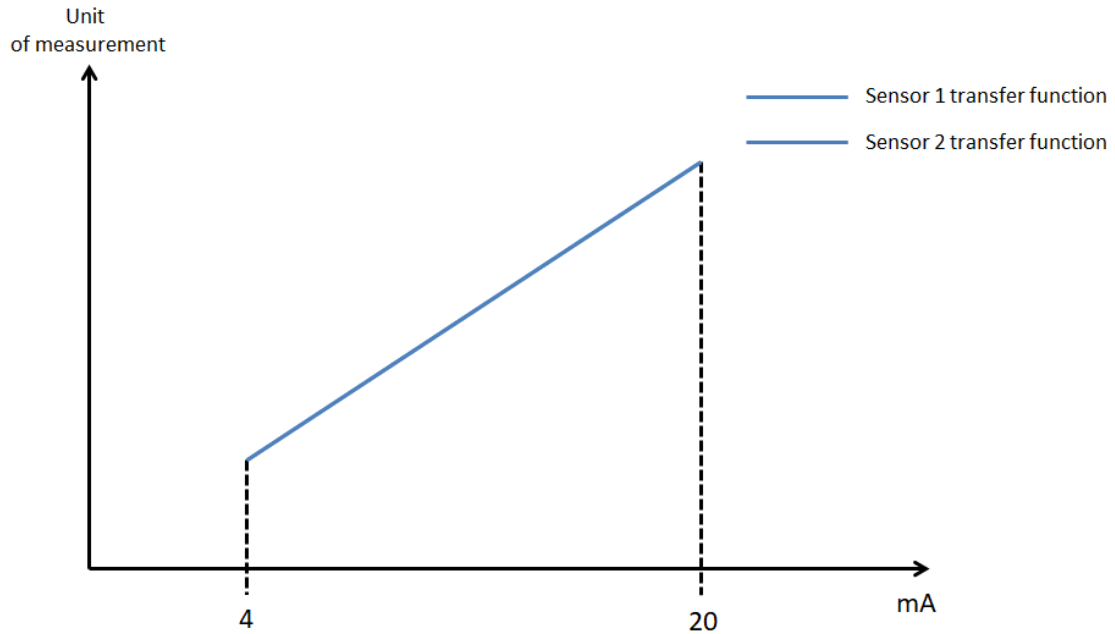

**Different sensors**

Different sensors

Scale		
0 mA (0V):	<input type="text" value="0"/>	Kg
20mA (10V):	<input type="text" value="1000"/>	Kg
Slope	100 Kg/V	
Offset	0 Kg	

When this option is selected the sensors have different characteristics and for this reason it is allowed to enter the scale of the second sensor. Starting from this information, the MA4 module is able to calculate the difference between the two sensors even when they are different. The following figure shows two sensors with different characteristics.

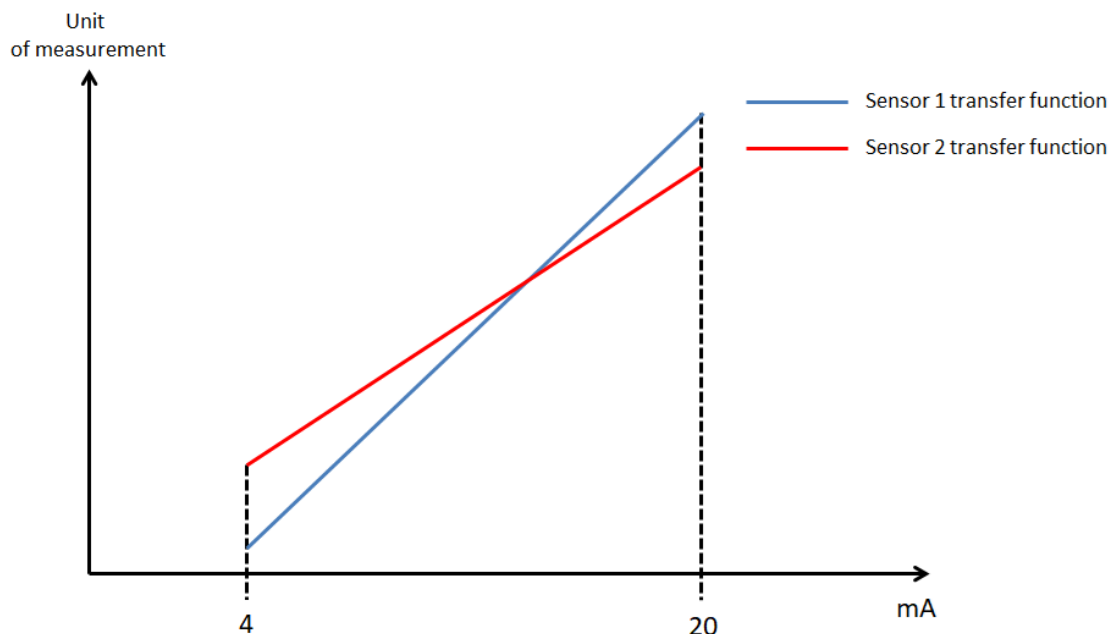

English

Measurement unit, Scale (minimum and maximum value)

**Measurement unit**

It defines the physical dimension of the measurement (E.g. Celsius, BAR, m/s and so on).

<b>Measurement unit</b>		
	<input type="text" value="c"/>	
<b>Scale</b>		
4 mA:	<input type="text" value="0"/>	c
20 mA:	<input type="text" value="100"/>	c
Slope	6,25 c/mA	
Offset	-25 c	

**Scale, minimum value**

It is the lowest value in physical dimensions corresponding to the minimum value outputted by the sensor. (4 mA for a 4-20mA sensor, 0mA for a 0-20mA sensor and 0V for a 0-10V sensor)

**Scale, maximum value**

it is the highest value in physical dimensions corresponding to the maximum value outputted by the sensor. (20 mA for a 0/4-20mA sensor and 10V for a 0-10V sensor)

DSC Design Software assumes that all the sensors have a linear transfer function and as a consequence computes automatically the slope and the offset of the transfer function given the value inputted by the user.

0÷20 mA Configuration  0÷20mA Configuration

Allow the user to use current output sensors whose measurements are valid starting from 0mA.

➔ **Note:** when this option is selected the disconnected cable and the minimum current limit diagnosis are not available anymore.

0÷10 V Configuration  0÷10V Input

Allow the user to use a 0÷10V output sensor whose measurements are valid starting from 0V.

➔ **Note:** when this option is selected the disconnected cable and the minimum voltage diagnosis are not available anymore.

## Window comparator, Enable threshold 1, Enable threshold 2, Hysteresis

Window comparator  
 Enable threshold1  
 Enable threshold2  
Hysteresis [0,1+6550,0]  
0,1 c

### Window comparator

When selected it enables the window comparator and as a consequence a label “Out1” appears on the analog block. The “Out1” label is the output of the comparator whose behavior will be explained later.

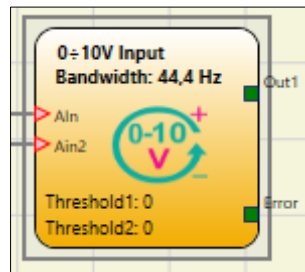

When the window comparator is enabled the user can choose a high threshold value a low threshold value and an hysteresis value. All the values are in physical dimension unit.

Window comparator  
High threshold  
0 c  
-0,1 c  
Low threshold  
0 c  
-0,1 c  
Hysteresis [0,1+6550,0]  
0,1 c

The output state of the window comparator depends on the value of the measurement and on its current state. There are two possible states:

- ➔ OUT OF WINDOW: the output of the comparator is a logic 0 (FALSE)
- ➔ IN WINDOW: the output of the comparator is a logic 1 (TRUE)



If the measurement values are over “High threshold” value or under “Low threshold - Hysteresis” value then the state of the window comparator is “OUT OF WINDOW”.

If the state of the window comparator is “IN WINDOW” and measurement values are under “High threshold” value or over “Low threshold - Hysteresis” value, then the state of the window comparator still remains “IN WINDOW”.

If the state of the window comparator is “OUT OF WINDOW” and measurement values are over “High threshold - Hysteresis” value or under “Low threshold” value then the state of the window comparator still remains “OUT OF WINDOW”.

The window comparator turns its state into “IN WINDOW” only if the measurement values are under “High threshold - Hysteresis” value or over “Low threshold” value.

In the following picture and table is given an example of the behavior of the window comparator.

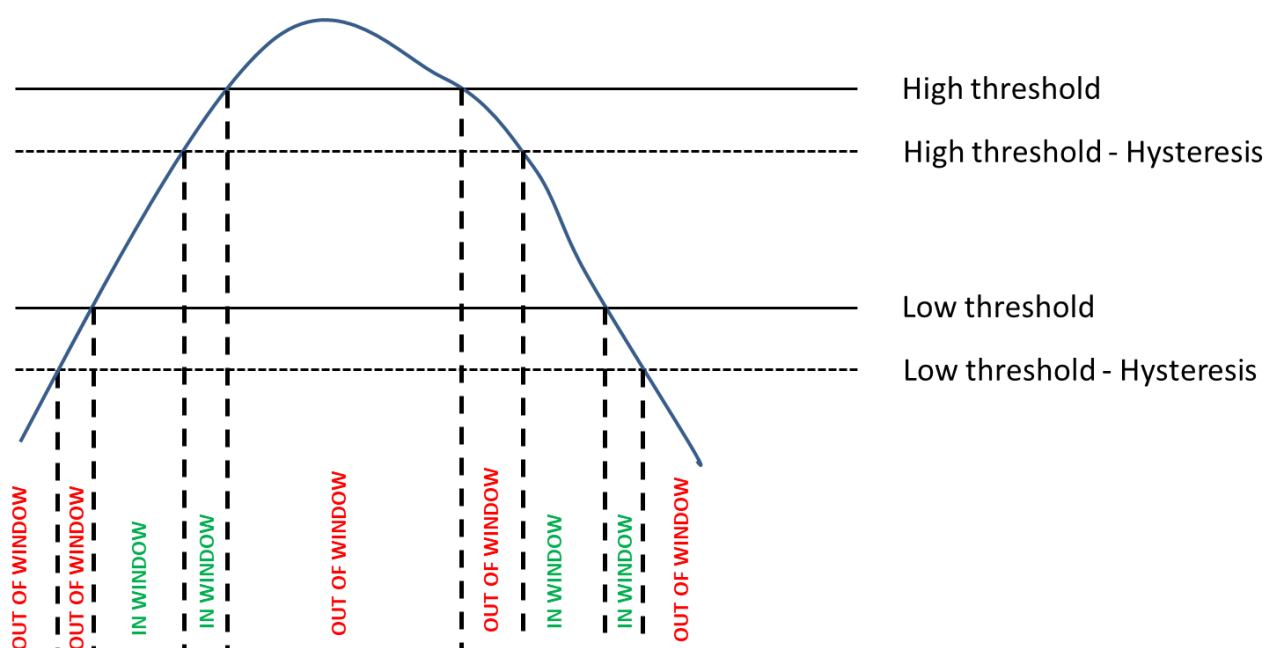
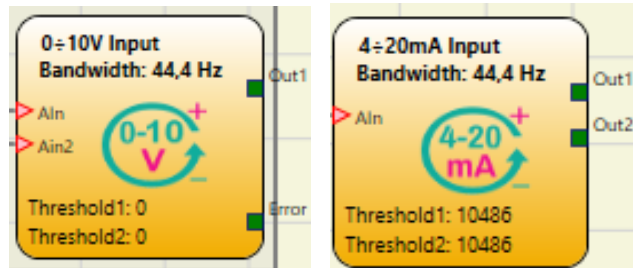

Figure 68 – Example of window comparator behavior where the blu line represents the measurement

Measurement value	Current state of window comparator	Next state of window comparator
Measure < Low threshold value - hysteresis	OUT OF WINDOW	OUT OF WINDOW
Measure > High threshold	OUT OF WINDOW	OUT OF WINDOW
Measure >= High threshold value - hysteresis	OUT OF WINDOW	OUT OF WINDOW
Measure <= Low threshold value	OUT OF WINDOW	OUT OF WINDOW
Measure < High threshold value - hysteresis	OUT OF WINDOW	IN WINDOW
Measure > Low threshold value	OUT OF WINDOW	IN WINDOW
Measure < High threshold value	IN WINDOW	IN WINDOW
Measure > Low threshold value - hysteresis	IN WINDOW	IN WINDOW

## Enable threshold 1 / Enable threshold 2

When selected it enables threshold comparator 1 or comparator 2 or both. As a consequence a label "Out1", "Out2" or both appear on the analog block. The labels are the output of the comparator whose behavior will be explained later. Threshold 1 and threshold 2 comparators are completely independent.



When the threshold comparator is enabled the user can set a threshold value and a relate hysteresis. All the values are in physical dimension unit.

The output state of the threshold comparator depends on the value of the measurement and on its current state. There are two possible states:

- ➔ OVER THRESHOLD: the output of the comparator is a logic 1 (TRUE)
- ➔ UNDER THRESHOLD: the output of the comparator is a logic 0 (FALSE)

If the measurement values are over "Threshold" value then the state of the threshold comparator is "OVER THRESHOLD" until the measurements stay over "Threshold-Hysteresis" value.

If the measurement values are under "Threshold-Hysteresis" value then the state of the threshold comparator is "UNDER THRESHOLD" until the measurements stay under "Threshold" value.

In the following picture is given an example of the behavior of the threshold comparator.

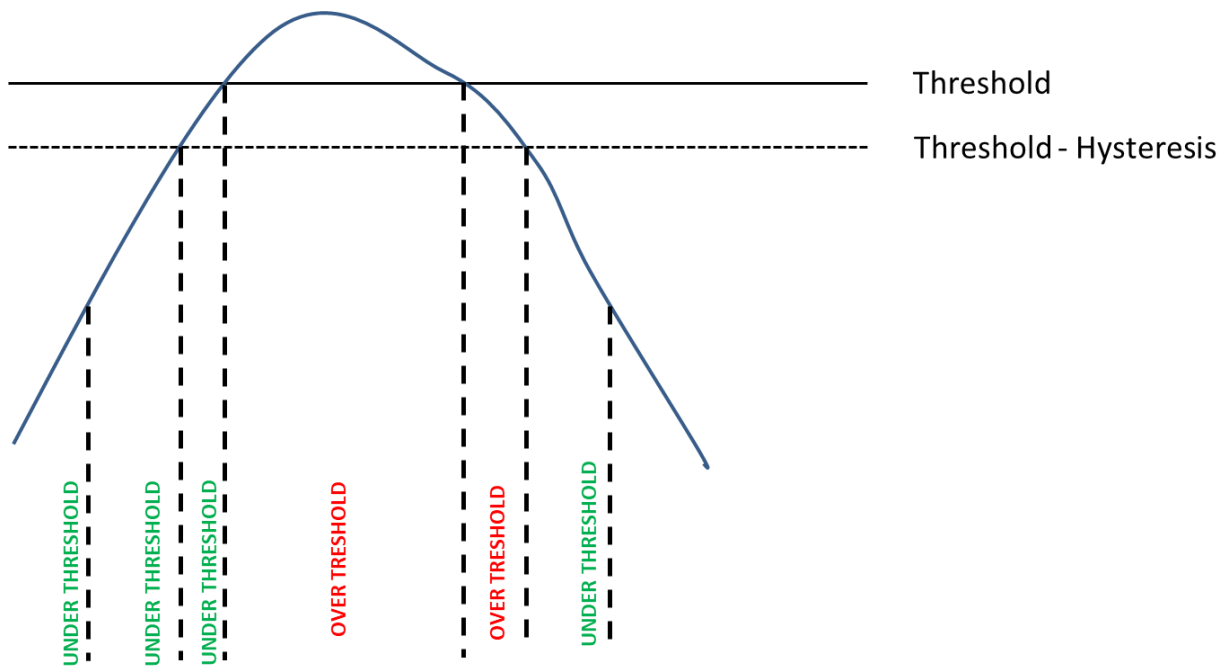

Figure 69 – Example of threshold comparator behavior where the blue line represents the measurement

### Samples per second

Let the user to choose the number of sampling per second of the Analog to Digital Sigma Delta converter. A low value would have better performance in terms of noise while an high value would have better performance in terms of response speed. The value 50 and 60 enhance line filter rejection.

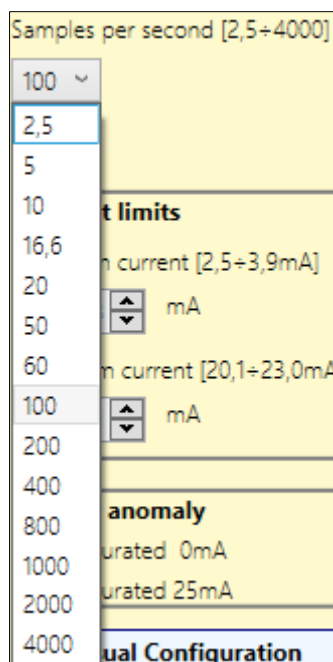
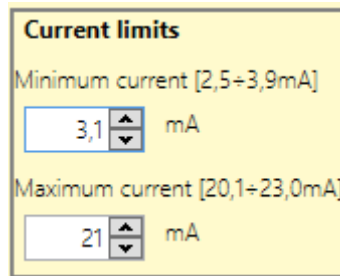

Figure 70 - List of samples per second possible values

Current/Voltage limits: minimum current and maximum current/voltage

**Current sensors**



The user can set the range of valid measurement values setting a minimum current and a maximum current.

If the measurement values are under the minimum value or over the maximum value a diagnosis is set.

The allowable minimum current values range from 2.5 mA to 3.9 mA while the allowable maximum current values range from 20.1 mA to 23 mA.

**Voltage sensors**

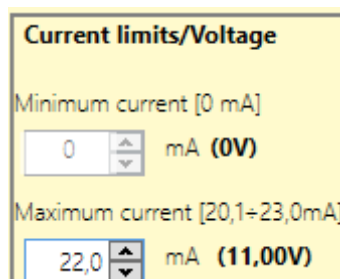

The user can set the range of valid measurement values by set a maximum voltage.

If the measurement values are over the maximum value a diagnosis is set.

The allowable maximum voltage values range from 10.05 V to 11.5 V.

The following table summarize MA4 module behaviour as a function of measurement values.

Measurement value	Diagnostic set?
Measure < Minimum current limit	YES
Measure > Maximum current/voltage limit	YES
Minimum current limit < Measure < Maximum current/voltage limit	NO

Sensor anomaly: measure saturated at 0 mA or 25 mA

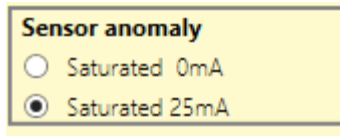

This option let the user to choose which value MA4 will force to the measurement when a sensor anomaly is detected.

The list of sensor anomalies are reported below:

- Disconnected cable (only for 4mA/20mA sensors)
- Isolated channel power supply overload
- Isolated channel input overload



When this flag is checked the raw value of the measurements are available to MSD. This is highlighted on input block by a light green square near the label “Analog”.

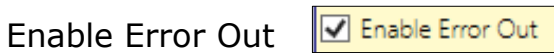
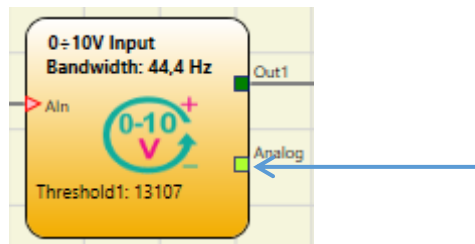

When this flag is checked the a digital signal is available to indicate an error when an anomaly on a sensor is detected. This is highlighted on input block by a dark green square near the label “Error”.

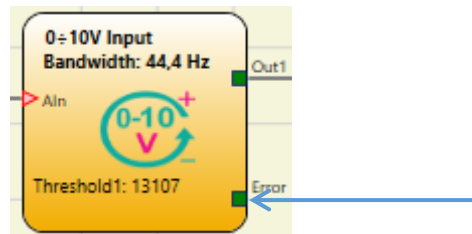

The following table shown the possible values of the “Error” signal.

Anomaly	“Error” Value
Present	1 (TRUE)
Not present	0 (FALSE)

## OPERATOR FUNCTION BLOCKS

All the input of these operators could be inverted (logical NOT). It could be done clicking with the right mouse key on the input to be inverted. A little circle will be showed on the inverted input. To cancel the inversion, simply click another time on the same input pin.

➔ The maximum number of functional blocks is 64 with M1 or 128 with M1S.

### LOGICAL OPERATORS

#### AND

Logical AND returns an output of 1 (TRUE) if all the inputs are 1 (TRUE).

In <sub>1</sub>	In <sub>2</sub>	In <sub>x</sub>	Out
0	0	0	0
1	0	0	0
0	1	0	0
1	1	0	0
0	0	1	0
1	0	1	0
0	1	1	0
1	1	1	1

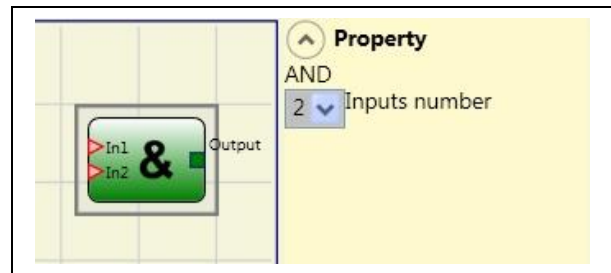

#### Parameters

*Number of inputs:* this is used to set between 2 and 8 inputs.

#### NAND

Logical NAND returns an output of 0 (FALSE) if all the inputs are 1 (TRUE).

In <sub>1</sub>	In <sub>2</sub>	In <sub>x</sub>	Out
0	0	0	1
1	0	0	1
0	1	0	1
1	1	0	1
0	0	1	1
1	0	1	1
0	1	1	1
1	1	1	0

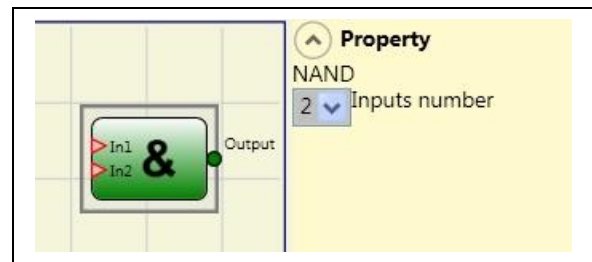

#### Parameters

*Number of inputs:* this is used to set between 2 and 8 inputs.

## NOT

Logical NOT inverts the logical status of the input.

In	Out
0	1
1	0

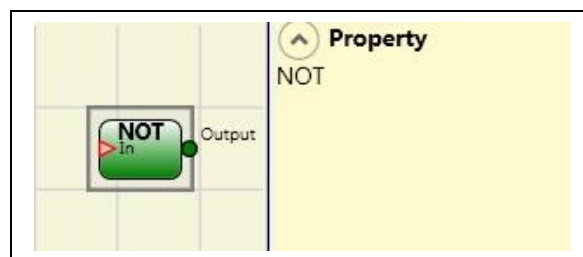

## OR

Logical OR returns an output of 1 (TRUE) if at least one of the inputs is 1 (TRUE).

In <sub>1</sub>	In <sub>2</sub>	In <sub>x</sub>	Out
0	0	0	0
1	0	0	1
0	1	0	1
1	1	0	1
0	0	1	1
1	0	1	1
0	1	1	1
1	1	1	1

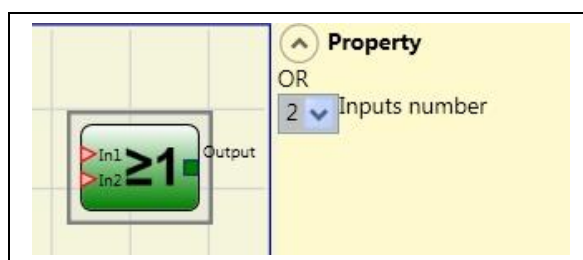

## Parameters

*Number of inputs:* this is used to set between 2 and 8 inputs.

## NOR

Logical NOR returns an output of 0 (FALSE) if at least one of the inputs is 1 (TRUE).

In <sub>1</sub>	In <sub>2</sub>	In <sub>x</sub>	Out
0	0	0	1
1	0	0	0
0	1	0	0
1	1	0	0
0	0	1	0
1	0	1	0
0	1	1	0
1	1	1	0

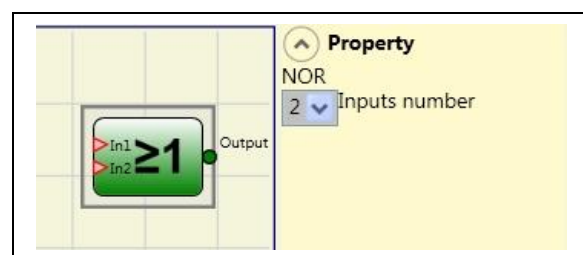

## Parameters

*Number of inputs:* this is used to set between 2 and 8 inputs.

## XOR

Logical XOR returns an output 0 (FALSE) if the input's number at 1 (TRUE) is even or the inputs are all 0 (FALSE).

In1	In2	Inx	Out
0	0	0	0
1	0	0	1
0	1	0	1
1	1	0	0
0	0	1	1
1	0	1	0
0	1	1	0
1	1	1	1

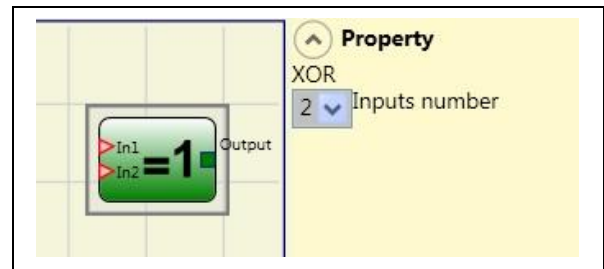

### Parameters

*Number of inputs:* this is used to set between 2 and 8 inputs.

## XNOR

Logical XNOR returns an output 1 (TRUE) if the input's number at 1 (TRUE) is even or the inputs are all 0 (FALSE).

In1	In2	Inx	Out
0	0	0	1
1	0	0	0
0	1	0	0
1	1	0	1
0	0	1	0
1	0	1	1
0	1	1	1
1	1	1	0

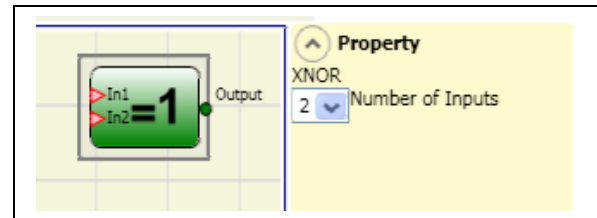

### Parameters

*Number of inputs:* this is used to set between 2 and 8 inputs.



## LOGICAL MACRO

This operator enables the grouping together of two or three logic gates.

A maximum of 8 inputs is foreseen.

The result of the first two operators converges into a third operator, the result of which is the OUTPUT.

### Parameters

*Logic inputs 1, 2:* enables the selection of the number of logic inputs (from 1 to 7).

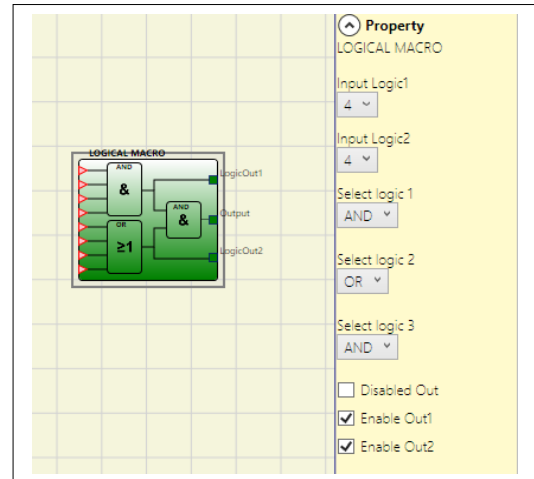
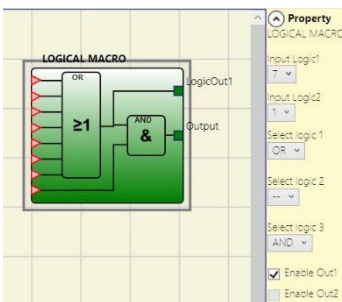

If one of the Logic Inputs equals "1", the corresponding logic is disabled and the input is directly connected to the end logic (refer to diagram opposite for example).

*Select Logic 1, 2, 3:* enables the selection of one of the following types of operator: AND, NAND, OR, NOR, XOR, XNOR, SR Flip-Flop (the latter only for logic 3).

*Disable OUT:* If selected, it deactivates the main output allowing to use only logics 1 and/or 2 enabling their respective outputs

*Enable (OUT1, OUT2):* If selected, it activates an output with the result of logics 1 and/or 2.

## MULTIPLEXER

Logical MULTIPLEXER forwards the signal of the inputs to the output according to the Sel selection. If the SEL1÷SEL4 have only one bit set, the selected *In n* is connected to the Output. If the SEL inputs are:

- more than one = 1 (TRUE)
  - none = 1 (TRUE)
- the output is set to 0 (FALSE) independently from the *In n* values.

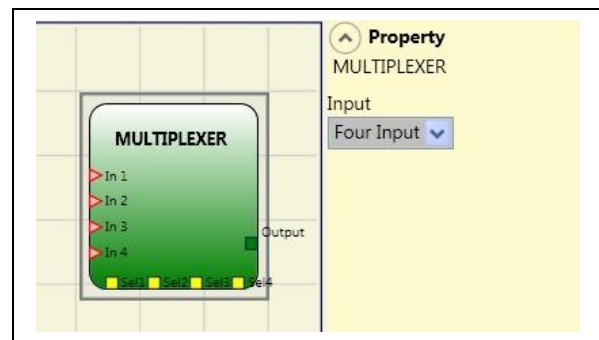

### Parameters

*Number of inputs:* this is used to set between 2 and 4 inputs.

DIGITAL COMPARATOR (M1S only)

The digital comparator allows to compare (in binary format) a group of signals with a constant or two groups of signals to each other

Comparison with constant

In this case the Signal Comparator check must not be activated.

The DIGITAL COMPARATOR block allows to compare a series of input signals (from 2 to a maximum of 8) with a integer constant that can vary from 0 to 255.

Input In1 is the LSB (least significant bit) while input In8 (or less if the number of inputs selected is less than 8) is the MSB (most significant bit).

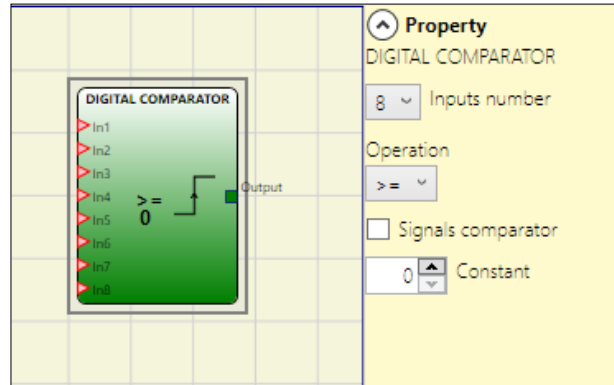

Example of operator with 8 inputs:

- In1 → 0
- In2 → 1
- In3 → 1
- In4 → 0
- In5 → 1
- In6 → 0
- In7 → 0
- In8 → 1

Decimal value equal to 150.

Example of operator with 5 inputs:

- In1 → 0
- In2 → 1
- In3 → 0
- In4 → 1
- In5 → 1

Decimal value equal to 26.

Among the various operations that can be used are:

- < Lower The OUT output will be 1 (TRUE) as long as the input value is less than the decimal value set as constant. The OUT output will be set to 0 (FALSE) when the input value is higher than or equal to the decimal value set as constant.
- >= Higher or equal The OUT output will be 1 (TRUE) as long as the input value is higher than or equal to the decimal value set as constant. The OUT output will be set to 0 (FALSE) when the input value is lower than the decimal value set as constant.
- > Higher The OUT output will be 1 (TRUE) as long as the input value is higher than the decimal value set as constant. The OUT output will be set to 0 (FALSE) when the input value is lower than or equal to the decimal value set as constant.
- <= Lower or equal The OUT output will be 1 (TRUE) as long as the input value is lower than or equal to the decimal value set as constant. The OUT output will be set to 0 (FALSE) when the input value is higher than the decimal value set as constant.
- = Equal The OUT output will be 1 (TRUE) as long as the input value is equal to the decimal value set as constant. The OUT output will be set to 0 (FALSE) when the input value is different from the decimal value set as constant.
- != Different The OUT output will be 1 (TRUE) as long as the input value is different from the decimal value set as constant. The OUT output will be set to 0 (FALSE) when the input value is equal to the decimal value set as constant.

### Signal comparison

Signal comparison: Selecting this item will allow the DIGITAL COMPARATOR operator to compare the first four A inputs (In1\_A...In4\_A) with the second four B inputs (In1\_B...In4\_B).

Depending on the value of the inputs and the operation selected, the following results will be obtained:

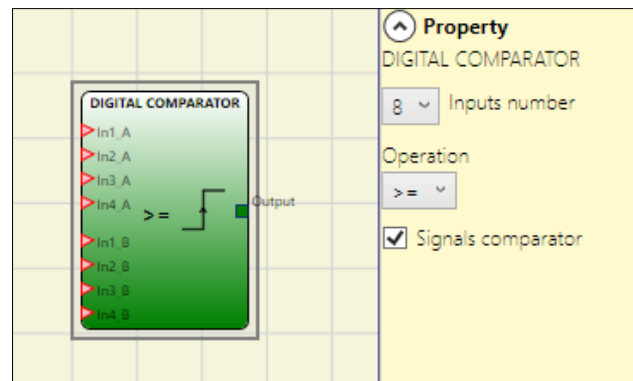

- < Lower: The OUT output will be 1 (TRUE) as long as the value of A inputs is lower than the value of B inputs. The OUT output will be set to 0 (FALSE) when the value of A inputs is higher than or equal to the value of B inputs.
- >= Higher or equal: The OUT output will be 1 (TRUE) as long as the value of A inputs is higher than or equal to the value of B inputs. The OUT output will be set to 0 (FALSE) when the value of A inputs is lower than the value of B inputs.
- > Higher: The OUT output will be 1 (TRUE) as long as the value of A inputs is higher than the value of B inputs. The OUT output will be set to 0 (FALSE) when the value of A inputs is lower than or equal to the value of B inputs.
- <= Lower or equal: The OUT output will be 1 (TRUE) as long as the value of A inputs is lower than or equal to the value of B inputs. The OUT output will be set to 0 (FALSE) when the value of A inputs is higher than the value of B inputs.
- = Equal: The OUT output will be 1 (TRUE) as long as the value of A inputs is equal to the value of B inputs. The OUT output will be set to 0 (FALSE) when the value of A inputs is different from the value of B inputs.
- != Different: The OUT output will be 1 (TRUE) as long as the value of A inputs is different from the value of B inputs. The OUT output will be set to 0 (FALSE) when the value of A inputs is equal to the value of B inputs.

## MEMORY OPERATORS

MEMORY operators can be used if you decide to save any data (TRUE or FALSE) from other project components.

Status changes are performed according to the truth tables shown for each operator.

### D FLIP FLOP (max number = 16 with M1, 32 with M1S)

The D FLIP FLOP operator saves the previously set status on output Q according to the following truth table.

Preset	Clear	Ck	D	Q
1	0	X	X	1
0	1	X	X	0
1	1	X	X	0
0	0	L	X	Keep memory
0	0	Rising edge	1	1
0	0	Rising edge	0	0

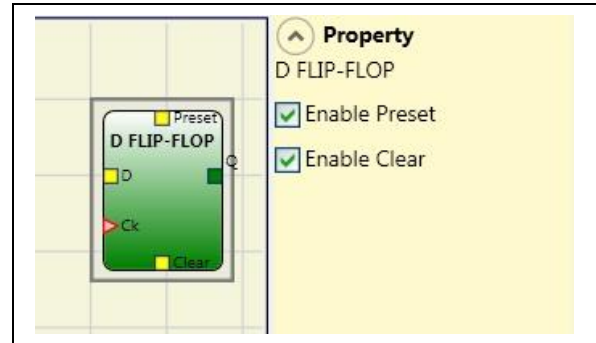

### Parameters

**Preset:** If selected enables output Q to be set to 1 (TRUE).

**Clear:** If selected enables the saving process to be reset.

### T FLIP FLOP (max number = 16 with M1, 32 with M1S)

This operator switches the Q output at each rising edge of the T input (Toggle).

### Parameters

**Enable Clear:** If selected enables the saving process to be reset.

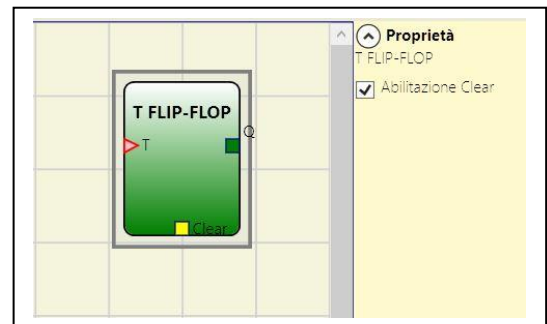

### SR FLIP FLOP

SR FLIP FLOP operator brings output Q at 1 with Set, 0 with Reset. See the following truth table.

SET	RESET	Q
0	0	Keep memory
0	1	0
1	0	1
1	1	0

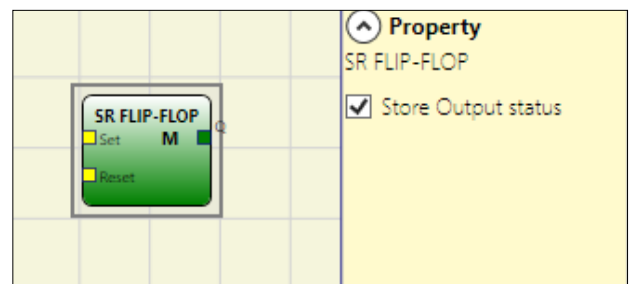

## Parameters

**Store output status:** If selected, it stores the output status of the Flip-flop in non-volatile memory every time it is changed. When the system is turned on, the last stored value is restored.

It is possible to have up to 8 Flip-Flops with output status storage that will be distinguishable by an 'M'.

- ➔ Some limitations to the use of this storage. The maximum time required for a single storage is estimated at 50ms and the maximum number of possible storages is set at 100000.
- ➔ The total number of storages must not exceed the set limit, otherwise the operational life of the product will be reduced, and the frequency of such storages must be sufficiently low to enable them to be stored safely.

## USER RESTART MANUAL

(max number = 16 with M1, 32 with M1S with other RESTART operators)

The USER RESTART MANUAL operator saves the restart signal according to the following truth table.

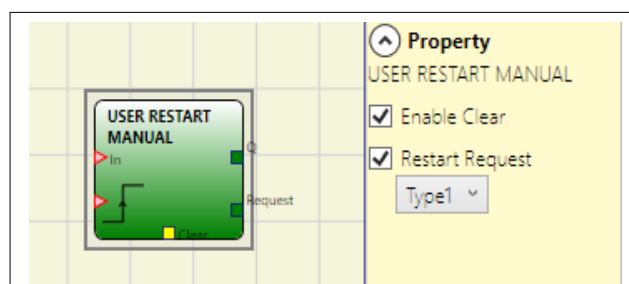

Clear	Restart	In	Q	Restart Request Type 1	Restart Request Type 2*
1	X	X	0	0	1
X	X	0	0	0	1
0	0	1	Keep Memory	1	Blinking 1Hz
0	Rising Edge	1	1	0	0

## Parameters

**Clear enable:** If selected, enables an input to reset the memorization.

**Restart request (only M1S):** If selected, it enables an output that can be used to signal the possibility of performing the Restart. The behaviour can be of type 1 or type 2 (type 2 only with M1S) as represented in the truth table.

\*This output uses a system timer

**USER RESTART MONITORED**

(max number = 16 with M1, 32 with M1S with other RESTART operators)

The USER RESTART MONITORED operator is used to save the restart signal according to the following truth table.

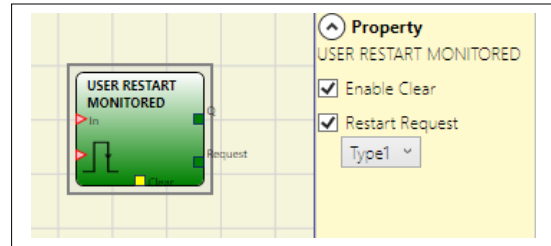

Clear	Restart	In	Q	Restart Request Type 1	Restart Request Type 2*
1	X	X	0	0	1
X	X	0	0	0	1
0	0	1	Keep Memory	1	Blinking 1Hz
0		1	1	0	0

**Parameters**

*Clear enable:* If selected, enables an input to reset the memorization.

*Restart request (only M1S):* If selected, it enables an output that can be used to signal the possibility of performing the Restart. The behaviour can be of type 1 or type 2 (type 2 only with M1S) as represented in the truth table.

\*This output uses a system timer

**MACRO RESTART MANUAL**

(max number = 16 with M1, 32 with M1S with other RESTART operators)

The MACRO RESTART MANUAL operator is used to combine a logic gate chosen by the user with the Restart Manual functional block ("USER RESTART MANUAL") in accordance with the following truth table.

Clear	Restart Logic Out	Input Logic Out	Output	Restart Request
1	X	X	0	0
X	X	0	0	0
0	0	1	Keep memory	1
0	Rising edge	1	1	0

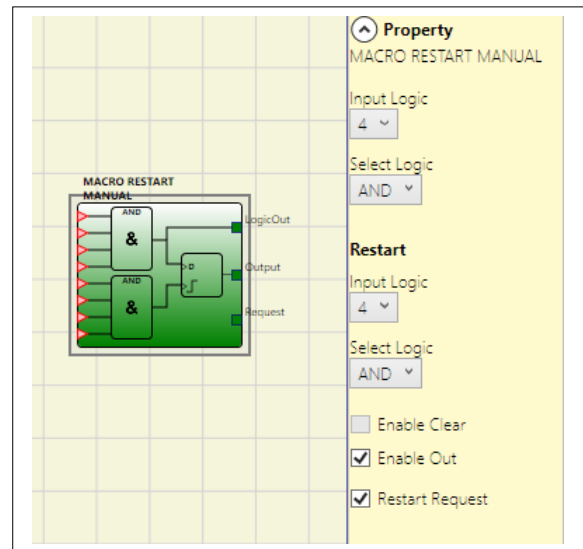

**Parameters**

*Input Logic:* enables the selection of the number of logic inputs (from 1 to 7). Selecting 1 the logic will not be considered.

*Select Logic:* enables the selection of one of the following types of operator: AND, NAND, OR, NOR, XOR, XNOR.

**(Restart) Input Logic:** enables the selection of the number of inputs for restart logic (from 1 to 7). If you select 1 the logic will not be considered.

**Select (Restart) Logic:** enables the selection of one of the following types of operator for restart logic: AND, NAND, OR, NOR, XOR, XNOR.

**Enable Clear:** If selected, enables an input to reset the memorization.

**Enable Out:** If selected activates an output with the result of the calculation done by the input logic.

**Restart request (only M1S):** If selected, it enables an output that can be used to signal the possibility of performing the Restart. The behaviour is represented in the truth table.

## MACRO RESTART MONITORED

(max number = 16 with M1, 32 with M1S with other RESTART operators)

The MACRO RESTART MONITORED operator is used to combine a logic gate chosen by the user with the Restart Manual functional block ("USER RESTART MONITORED") in accordance with the following truth table.

Clear	Restart Logic Out	Input Logic Out	Output	Restart Request
1	X	X	0	0
X	X	0	0	0
0	0	1	Keep memory	1
0		1	1	0

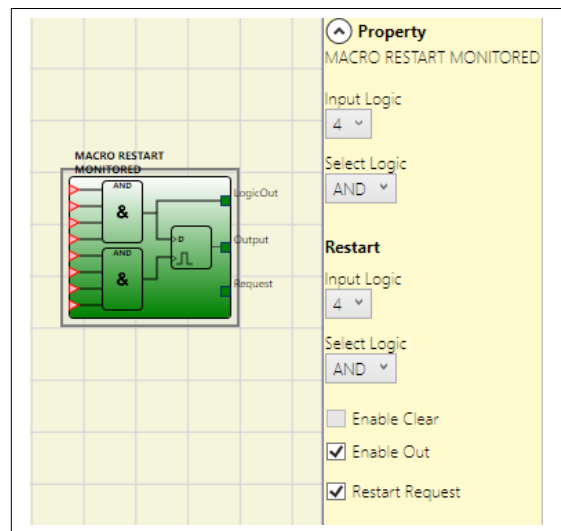

## Parameters

**Logic Inputs:** enables the selection of the number of logic inputs (from 1 to 7). If the operator selects 1 the logic will not be considered.

**Select Input Logic:** enables the selection of one of the following types of operator: AND, NAND, OR, NOR, XOR, XNOR.

**Restart Inputs (M1S only):** enables the selection of the number of inputs for restart logic (from 1 to 7). If you select 1 the logic will not be considered.

**Select Restart Logic (M1S only):** enables the selection of one of the following types of operator for restart logic: AND, NAND, OR, NOR, XOR, XNOR.

**Enable Clear:** If selected, enables an input to reset the memorization.

**Enable Out:** If selected activates an output with the result of the calculation done by the input logic.

**Restart request (M1S only):** If selected, it enables an output that can be used to signal the possibility of performing the Restart. The behaviour is represented in the truth table.

## PRE-RESET (M1S only) (max number = 32 with other RESTART operators)

The PRE-RESET operator can be used when there is no possibility of having a single reset button in a position from which a complete visibility of the hazardous area is available. In this case it is necessary to use a Pre-reset button inside the danger zone (at a point where there is complete visibility of the zone) and a second actual Reset button outside the dangerous zone.

For each of the two Prereset and Reset inputs, the transition 0-1-0 is always considered; in order to be considered valid, the latter must take place in a time between 500 ms and 5 s.

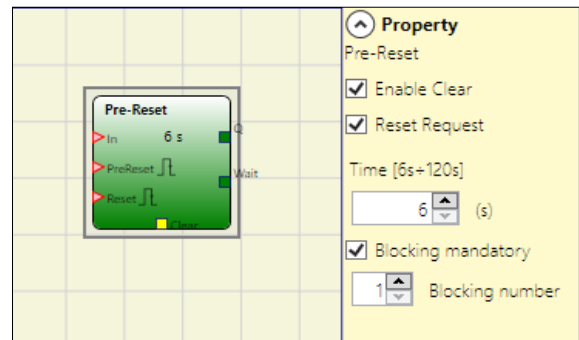

### Parametri

**Time:** The external reset is operative if pressed within a preset time configurable by the user in the range 6÷120s

**Blocking Mandatory:** If selected, it will be necessary to insert in the box a number corresponding to the number of blockings (or interruptions). The system will verify that from the transition of the PreReset signal to the transition of the Reset signal, there is not a number of blockings (transition 1-0 of the In signal) higher than the maximum number set but still higher than 0.

**Reset Request:** Enabling this item will make available an output from this operator. This signal is 1 from the PreReset signal transition to the end of the allowable time or to the next Reset signal transition.

**Enable Clear:** If selected, enables an input to reset the memorization.



**GUARD LOCK OPERATORS (max number = 4 with M1, 8 with M1S)**

**GUARD LOCK**

The “**GUARD LOCK**” operator is designed to control locking/unlocking of an **ELECTROMECHANICAL GUARD LOCK** in a variety of operating contexts.

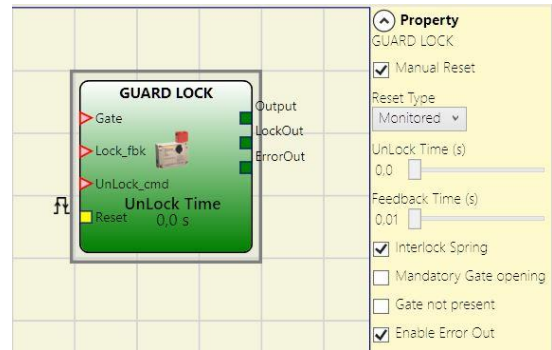

**Description of "GUARD LOCK" operator inputs/outputs**

**“Lock\_fbk” input**

The “Lock\_fbk” input is used to detect the status (feedback) of the electromagnet that unlocks/locks the guard lock.

Electromechanical guard locks are unlocked/locked via an electric control that energises/de-energises an electromagnet. Its status (energised/de-energised) is indicated by appropriate contacts. For example, the status of the electromagnet may be indicated by a normally open contact that is closed when the electromagnet is energised, as in the case shown in Figure 71.

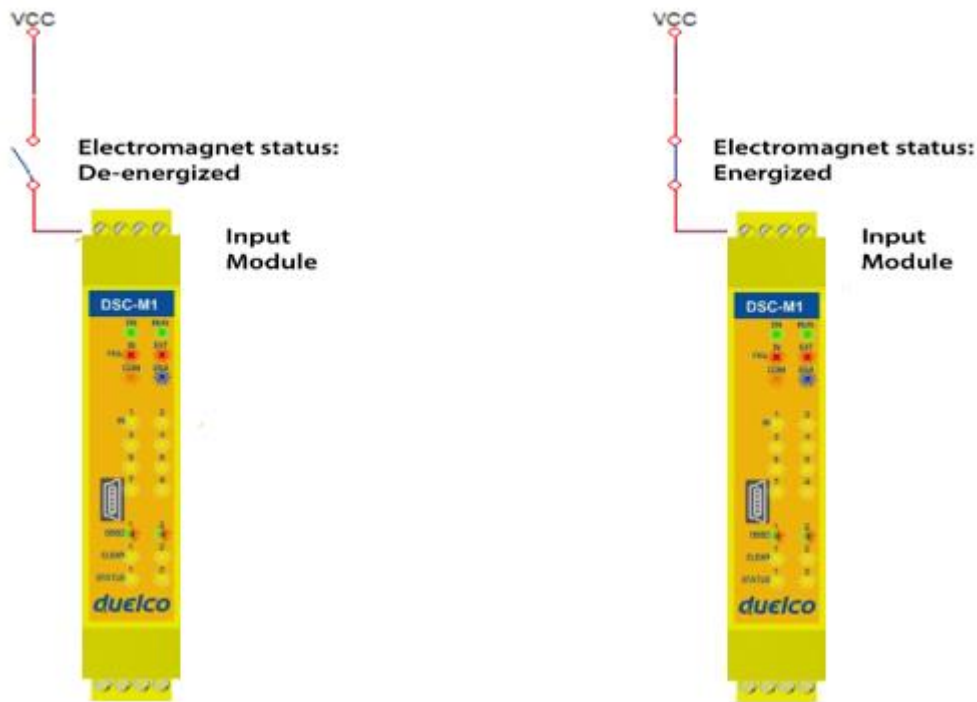

Figure 71 - Example of feedback of the status of the electromagnet of a guard lock. The signal received by the module is processed by the "Guard Lock" operator.

## “Gate” input

When the “Gate” input is selected, it detects the status (feedback) of the door/gate connected to the guard lock.

The status of the door/gate (GATE) is detected using specific contacts. For example, the status of the door/gate may be indicated by a normally open contact that is closed when the door/gate is closed, as in the case in Figure 72.

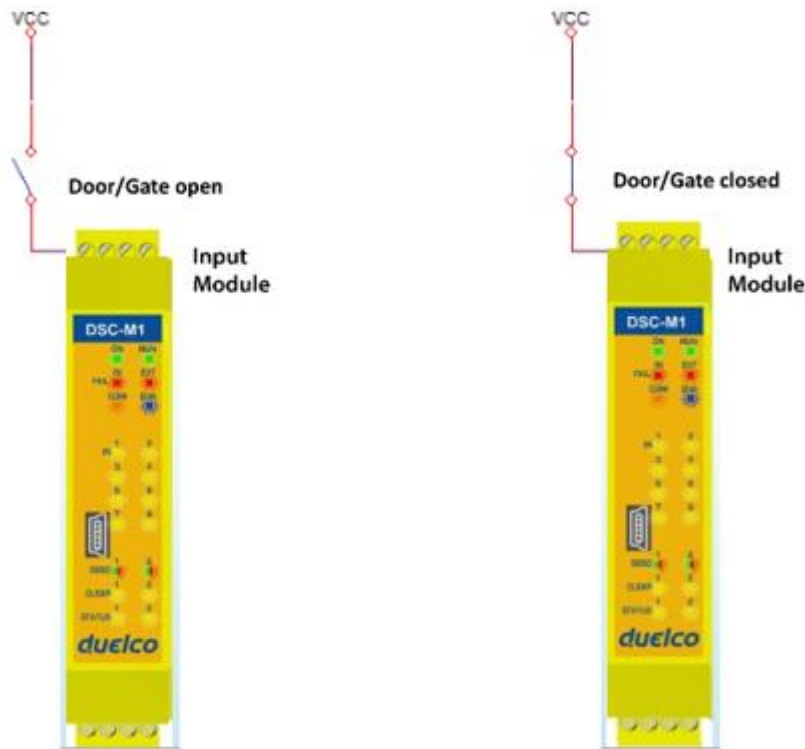

Figure 72 - Example of feedback of the status of a door/gate connected to the guard lock. The signal received by the module is processed by the "Guard Lock" operator.

## “Unlock\_cmd” input

The “Unlock\_cmd” input detects the command sent by the user to lock or unlock the guard lock. In detail:

- Request to unlock: the Unlock\_cmd signal must be set to LL1
- Request to lock: the Unlock\_cmd signal must be set to LL0

The command signal may be sent via a key, for example.

## “Output” out

This signal indicates the information shown in the table below, depending on its value.

	Value	Meaning
Output	LL1	<ul style="list-style-type: none"> <li>• Door/Gate closed</li> <li>• Guard lock locked</li> </ul>
Output	LL0	<ul style="list-style-type: none"> <li>• User request to unlock the guard lock</li> <li>• Error condition</li> </ul>

## “LockOut” output

This signal controls the guard lock electromagnet and can assume LL0 and LL1 value.

## “ErrorOut” output

If enabled, when this signal is set to LL1 it indicates an error in the control of the guard lock. It is set to LL0 when no errors have occurred.

## Operation: general description

The “Guard Lock” operator analyses consistency between the status of the “Unlock\_cmd” signal, the status of a door/gate (E-GATE), if present, via the “Gate” signal, and the status of the electromagnet via the “Lock\_fbk” signal. The main output, “Output”, is LL1 (TRUE) when the guard lock is closed and locked.

## Operation in the “no Gate” mode

In this case, the user must select the “Gate not present” parameter.

The **Lock\_Fbk** input must always be connected to a “LOCK FEEDBACK” input element (see the LOCK FEEDBACK section on page 112) that verifies the status of the guard lock electromagnet.

The **UnLock\_cmd** input can be connected freely in the diagram and determines the request to unlock the guard lock (when set to LL1).

The **Output** signal is LL1 (TRUE) if the safety guard is locked. When an unlock command is applied to the **UnLock\_cmd** input, the **Output** signal is set to LL0 and the guard lock is unlocked via the **LockOut** signal.

The **Output** signal can also be set to LL0 (FALSE) when error conditions are present. (e.g. *Feedback Time* exceeding the maximum allowed, etc.).

When the **Unlock\_cmd** signal is detected, the **LockOut** signal unlocks the guard lock after the *UnLock Time*, a parameter that can be defined by the user.

The time after which the electromagnet is activated depends entirely on the technical/physical characteristics of the specific device and may therefore vary according to the type of guard lock used. Thus, since the **LockOut** signal controls the activation of this device, the status of the **Lock\_Fbk** feedback signal will change at different times, depending on the type of guard lock. This variability can be avoided by changing the value of the *Feedback Time* parameter, which is the maximum delay accepted by the “Guard\_Lock” operator before the **Lock\_Fbk** signal switches status following a request to activate the electromagnet. Clearly, the following condition must be met:

$$Feedback\ Time \geq Electromagnet\ activation\ time$$

This will now be explained using a practical example.



## Example of operation in the "no Gate" mode

In this example the user unlocks the guard lock with the "SWITCH" block. The "LockOut" signal controls a "STATUS" block output that controls the guard lock electromagnet, the status of which is detected by the "Lock\_fbk" input via the "LOCK FEEDBACK" input block. "Output1" indicates the status of the operations.

The guard lock used in the example continues to be locked when the electromagnet is not energised. Therefore the "Interlock spring" option must be selected.

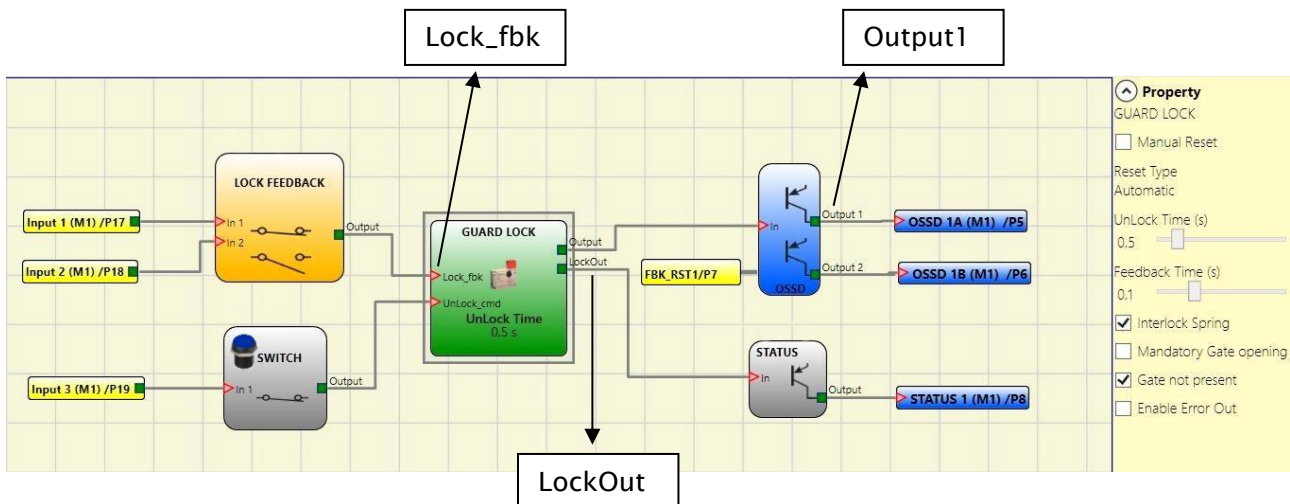

Figure 73 – Example of operation in the no Gate mode

➔ The Guard Lock operator parameters are shown on the right. On the left there is an example of an application diagram. The electromagnet feedback consists of two contacts, one normally closed and one normally open. When the electromagnet is energised the two contacts switch status.

Figure 74 shows the traces relative to the operation. These are described in detail below:

- (1) At this time the user requests to unlock the guard lock. The "COMMAND" signal switches from LL0 to LL1, and the "OUTPUT1" signal switches from LL1 to LL0.
- (2) At this time the electromagnet is activated with a delay of "Unlock Time", after the command is sent. This delay has been set to 0.5 seconds. The "ACTIV." signal switches from LL0 to LL1.
- (3) At this time the electromagnet is actually activated, 95ms after the command was sent. This delay is due to the technical characteristics of the electromagnet. In any case, 95ms is less than 100ms ("Feedback Time") and so no errors have occurred.
- (4) At this time the user releases the unlock command and the "COMMAND" signal switches from LL1 to LL0 as does the "ACTIV." activation signal.
- (5) At this time the electromagnet is actually deactivated, approx. 95ms after the command was sent due to the technical characteristics of the device. The guard lock is now locked.
- (6) As soon as the "Guard Lock" operator detects that the guard lock is locked, the "OUTPUT1" signal switches to LL1.

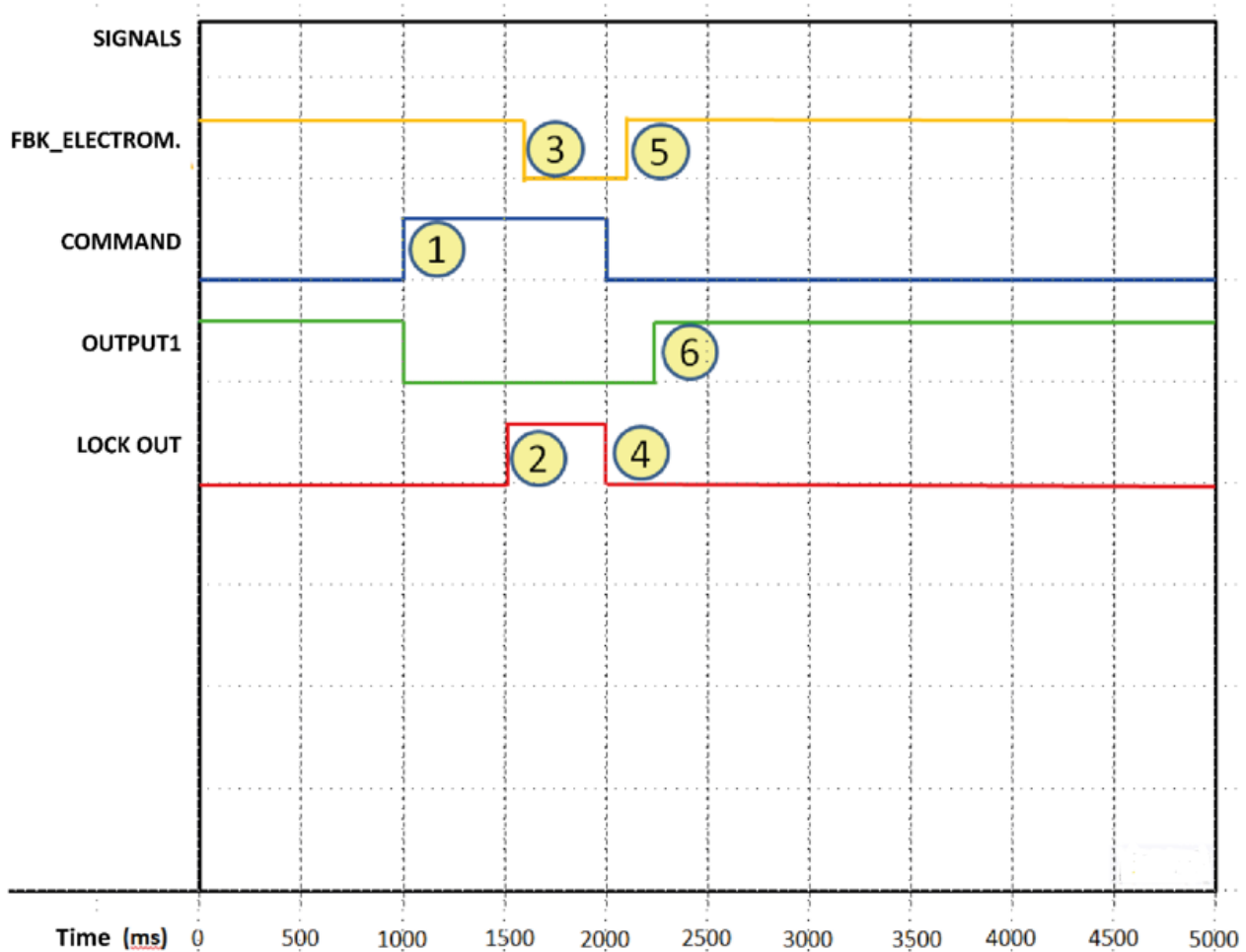

Figure 74 - Traces relative to "Guard Lock" block operation in the no gate mode.

### Operation in the "with Gate" mode

In this case, the user must **NOT** select the "Gate not present" parameter.

The **Gate** input must always be connected to an "E-GATE" input element (see the E-GATE (safety gate device) section on page 110) that verifies the status of the door/gate.

The **Lock\_Fbk** input must always be connected to a "LOCK FEEDBACK" input element (see the LOCK FEEDBACK section on page 112) that verifies the status of the guard lock electromagnet.

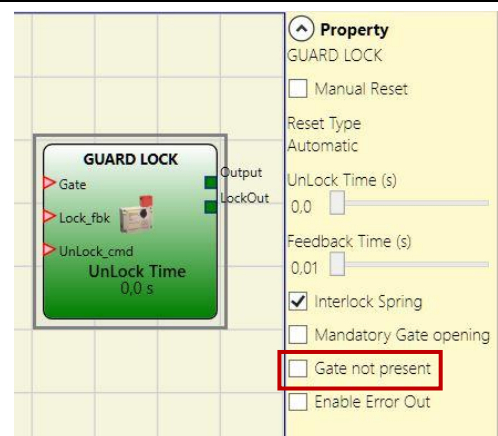

The **UnLock\_cmd** input can be connected freely in the diagram and determines the request to unlock the guard lock (when set to LL1).

The **Output** signal is LL1 (TRUE) if the safety guard is closed and locked. When an unlock command is applied to the **UnLock\_cmd** input, the **Output** signal is set to LL0 and the guard lock is unlocked via the **LockOut** signal. The **Output** signal can also be set to LL0 (FALSE) when error conditions are present (e.g. open door with guard lock locked, **Feedback Time** exceeding the maximum allowed, etc.).

When the **Unlock\_cmd** signal is detected, the **LockOut** signal unlocks the guard lock after the *UnLock Time*, a parameter that can be defined by the user.

The time after which the electromagnet is activated depends entirely on the technical/physical characteristics of the specific device and may therefore vary according to the type of guard lock used. Thus, since the **LockOut** signal controls the activation of this device, the status of the **Lock\_Fbk** feedback signal will change at different times, depending on the type of guard lock. This variability can be avoided by changing the value of the *Feedback Time* parameter, which is the maximum delay accepted by the "Guard\_Lock" operator before the **Lock\_Fbk** signal switches status following a request to activate the electromagnet. Clearly, the following condition must be met:

$$Feedback\ Time \geq Electromagnet\ activation\ time$$

This will now be explained using a practical example.

### Example of operation in the "with Gate" mode

In this example the user unlocks the guard lock with the "SWITCH" block. The "LockOut" signal controls an "STATUS" output that controls the guard lock electromagnet, the status of which is detected by the "Lock\_fbk" input via the "LOCK FEEDBACK" input block. "Output1" indicates the status of the operations.

The status of the safety gate is monitored by the "Gate" input via the "E\_GATE" input.

The guard lock used in the example continues to be locked when the electromagnet is not energised. Therefore the "Interlock spring" option must be selected.

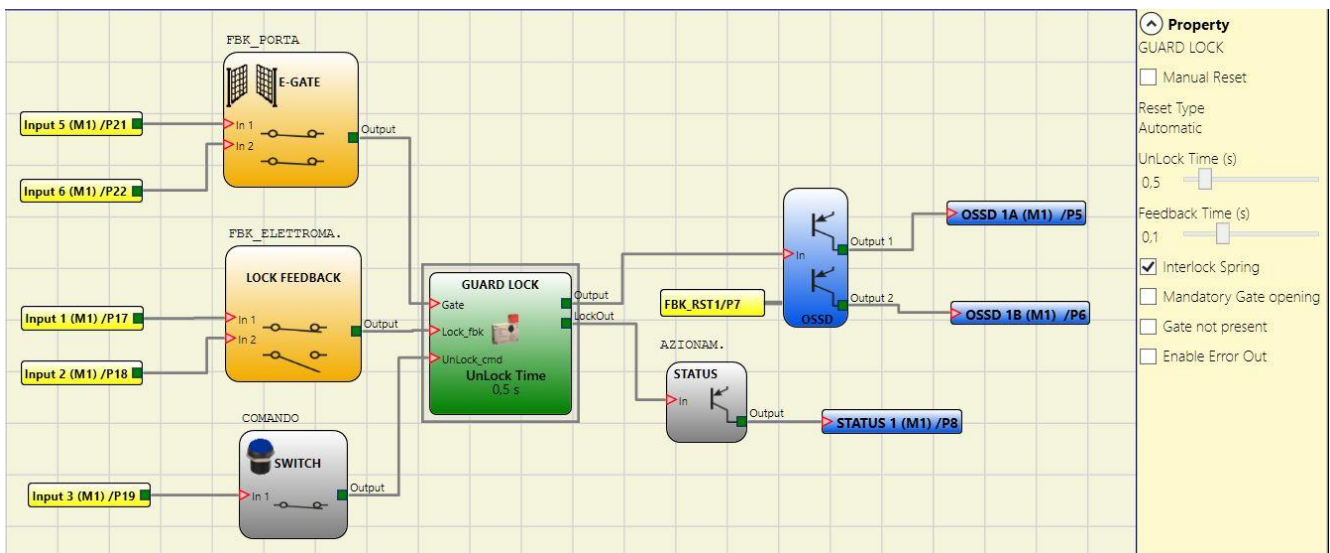

Figure 75 – Example of operation in the with Gate mode

➔ The Guard Lock operator parameters are shown on the right. On the left there is an example of an application diagram. The electromagnet feedback consists of two contacts, one normally closed and one normally open. When the electromagnet is energised the two contacts switch status. The gate feedback consists of two normally closed contacts.

Figure 76 shows the traces relative to the operation. These are described in detail below:

- (1) At this time the user requests to unlock the guard lock. The “COMMAND” signal switches from LL0 to LL1, and the “OUTPUT1” signal switches from LL1 to LL0.
- (2) At this time the electromagnet is activated with a delay of "Unlock Time", after the command is sent. This delay has been set to 0.5 seconds. The “ACTIV.” signal switches from LL0 to LL1.
- (3) At this time the electromagnet is actually activated, 95ms after the command was sent. This delay is due to the technical characteristics of the electromagnet. In any case, 95ms is less than 100ms ("Feedback Time") and so no errors have occurred.
- (4) At this time the guard lock is unlocked and the user opens the gate, the FBK\_GATE signal switches from LL1 to LL0.
- (5) At this time the user closes the gate and the FBK\_GATE signal thus switches from LL0 to LL1.
- (6) At this time the user releases the unlock gate command. The “Guard Lock” detects the gate closed condition, via the FBK\_GATE signal, and sends a command to lock the guard lock. The “ACTIV.” signal switches from LL1 to LL0.
- (7) At this time the electromagnet is actually deactivated, approx. 95ms after the command was sent due to the technical characteristics of the device. The guard lock is now locked.
- (8) As soon as the “Guard Lock” operator detects that the guard lock is locked and the gate is closed, the “OUTPUT1” signal switches to LL1.

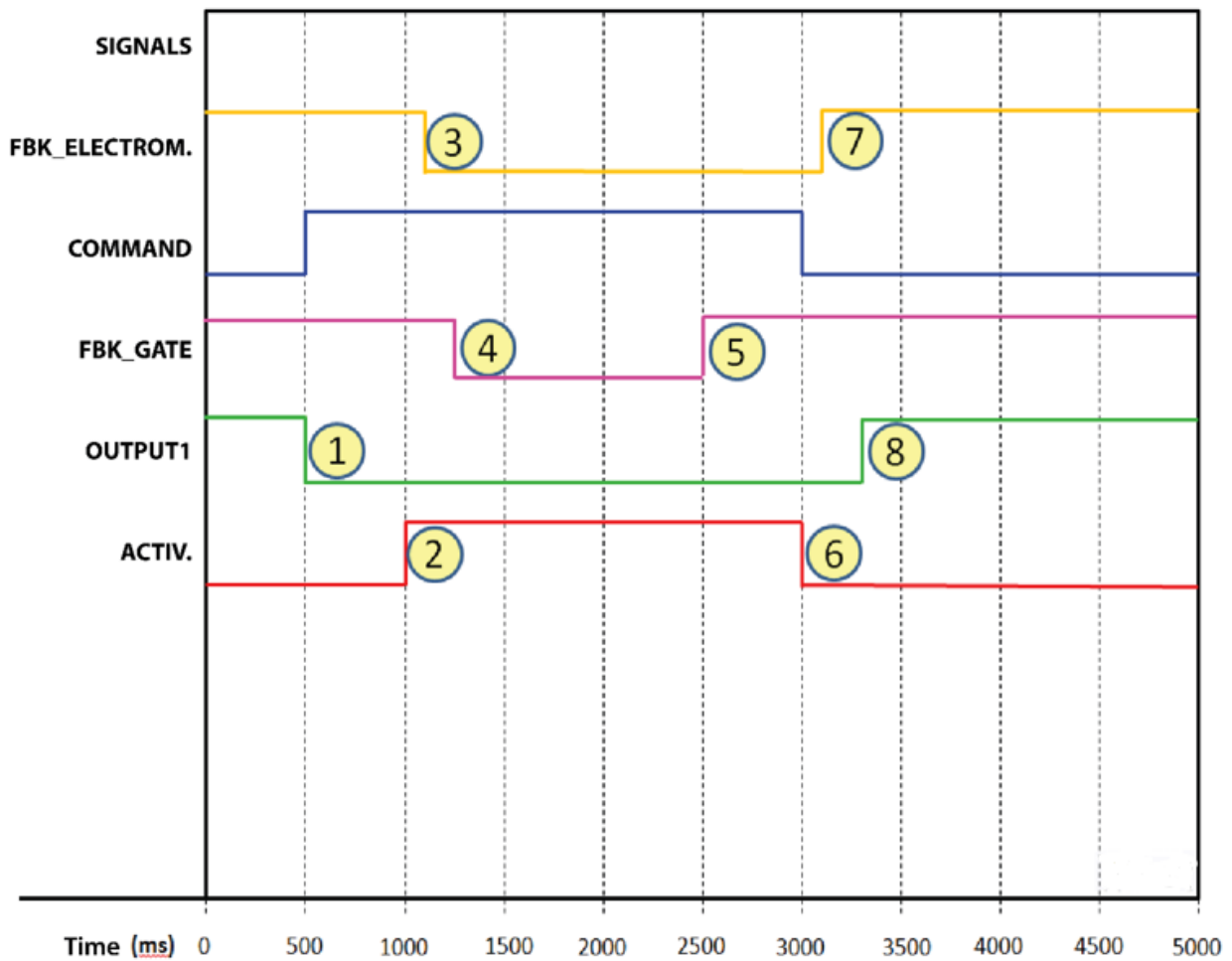
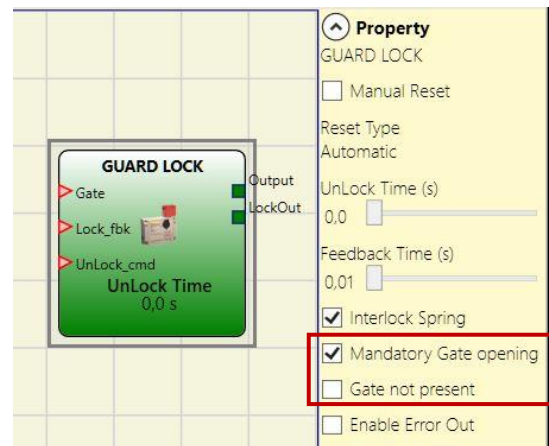

Figure 76 - Traces relative to “Guard Lock” block operation in the with gate mode.

## Operation in the "Mandatory Gate Opening" mode

In this case, the user must **NOT** select the "Gate not present" parameter and must select the "Mandatory Gate opening" parameter.

The **Gate** input must always be connected to an "E-GATE" input element (see the E-GATE (safety gate device) section on page 110) that verifies the status of the door/gate. **NB: IN THIS OPERATING MODE THE "GATE" INPUT MUST CONFIRM THE OPENING OF THE GATE.**



The **Lock\_Fbk** input must always be connected to a "LOCK FEEDBACK" input element (see the LOCK FEEDBACK section on page 112) that verifies the status of the guard lock electromagnet.

The **UnLock\_cmd** input can be connected freely in the diagram and determines the request to unlock the guard lock (when set to LL1).

The **Output** signal is LL1 (TRUE) if the safety guard is closed and locked. When an unlock command is applied to the **UnLock\_cmd** input, the **Output** signal is set to LL0 and the guard lock is unlocked via the **LockOut** signal.

The **Output** signal can also be set to LL0 (FALSE) when error conditions are present (e.g. open door with guard lock locked, **Feedback Time** exceeding the maximum allowed, etc.).

When the **UnLock\_cmd** signal is detected, the **LockOut** signal unlocks the guard lock after the *UnLock Time*, a parameter that can be defined by the user.

The time after which the electromagnet is activated depends entirely on the technical/physical characteristics of the specific device and may therefore vary according to the type of guard lock used. Thus, since the the **LockOut** signal controls the activation of this device, the status of the **Lock\_Fbk** feedback signal will change at different times, depending on the type of guard lock. This variability can be avoided by changing the value of the *Feedback Time* parameter, which is the maximum delay accepted by the "Guard\_Lock" operator before the **Lock\_Fbk** signal switches status following a request to activate the electromagnet. Clearly, the following condition must be met:

$$\textit{Feedback Time} \geq \textit{Electromagnet activation time}$$

This will now be explained using a practical example.



## Example of operation in the "Mandatory Gate Opening" mode

In this example the user unlocks the guard lock with the "SWITCH" block. The "LockOut" signal controls a "STATUS" output that controls the guard lock electromagnet, the status of which is detected by the "LOCK FEEDBACK" input block. "Output1" indicates the status of the operations.

The status of the safety gate is monitored by the "Gate" input via the "E\_GATE" input block, the "Mandatory Gate opening" parameter is selected.

The guard lock used in the example continues to be locked when the electromagnet is not energised. Therefore the "Interlock spring" option must be selected.

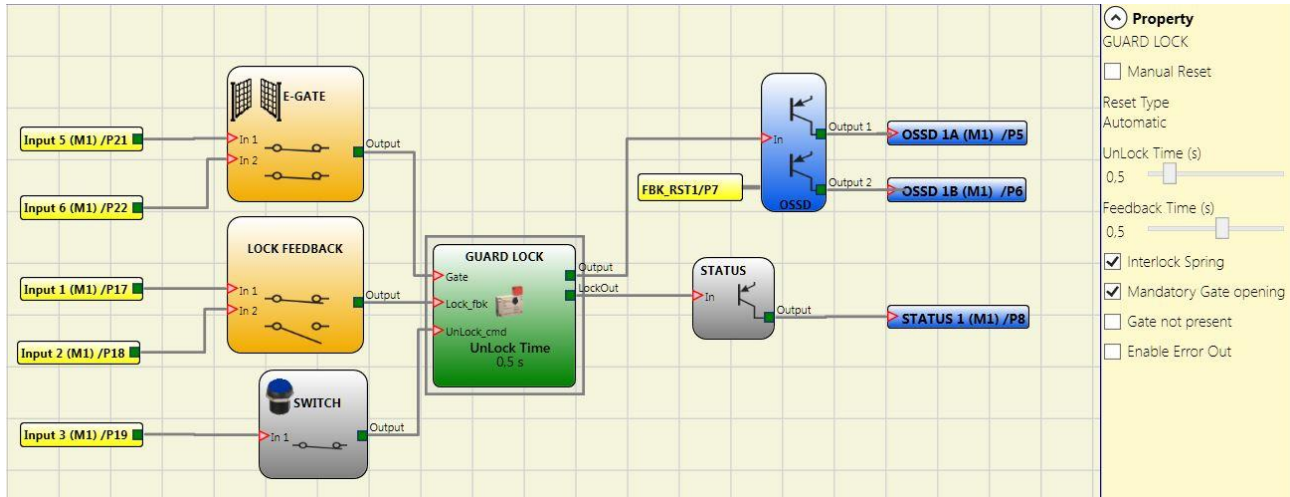

Figure 77 Example of operation in the Mandatory Gate Opening mode

➔ The Guard Lock operator parameters are shown on the right. On the left there is an example of an application diagram. The electromagnet feedback consists of two contacts, one normally closed and one normally open. When the electromagnet is energised the two contacts switch status. The gate feedback consists of two normally closed contacts.

Figure 78 shows the traces relative to the operation. These are described in detail below:

- (1) At this time the user requests to unlock the guard lock. The "COMMAND" signal switches from LL0 to LL1, and the "Output1" signal switches from LL1 to LL0.
- (2) At this time the electromagnet is activated with a delay of "Unlock Time", after the command is sent. This delay has been set to 0.5 seconds. The "ACTIV." signal switches from LL0 to LL1.
- (3) At this time the electromagnet is actually activated, 95ms after the command was sent. This delay is due to the technical characteristics of the electromagnet. In any case, 95ms is less than 100ms ("Feedback Time") and so no errors have occurred.
- (4) At this time the guard lock is unlocked and the user opens the gate. The FBK\_GATE signal switches from LL1 to LL0.
- (5) At this time the user closes the gate and the FBK\_GATE signal thus switches from LL0 to LL1.
- (6) At this time the user releases the unlock gate command. The "Guard Lock" detects the gate closed condition, via the FBK\_GATE signal, and sends a command to lock the guard lock. The "ACTIV." signal switches from LL1 to LL0.
- (7) At this time the electromagnet is actually deactivated, approx. 95ms after the command was sent due to the technical characteristics of the device. The guard lock is now locked.

(8) As soon as the “Guard Lock” operator detects that the guard lock is locked and the gate is closed, the “Output1” signal switches to LL1.

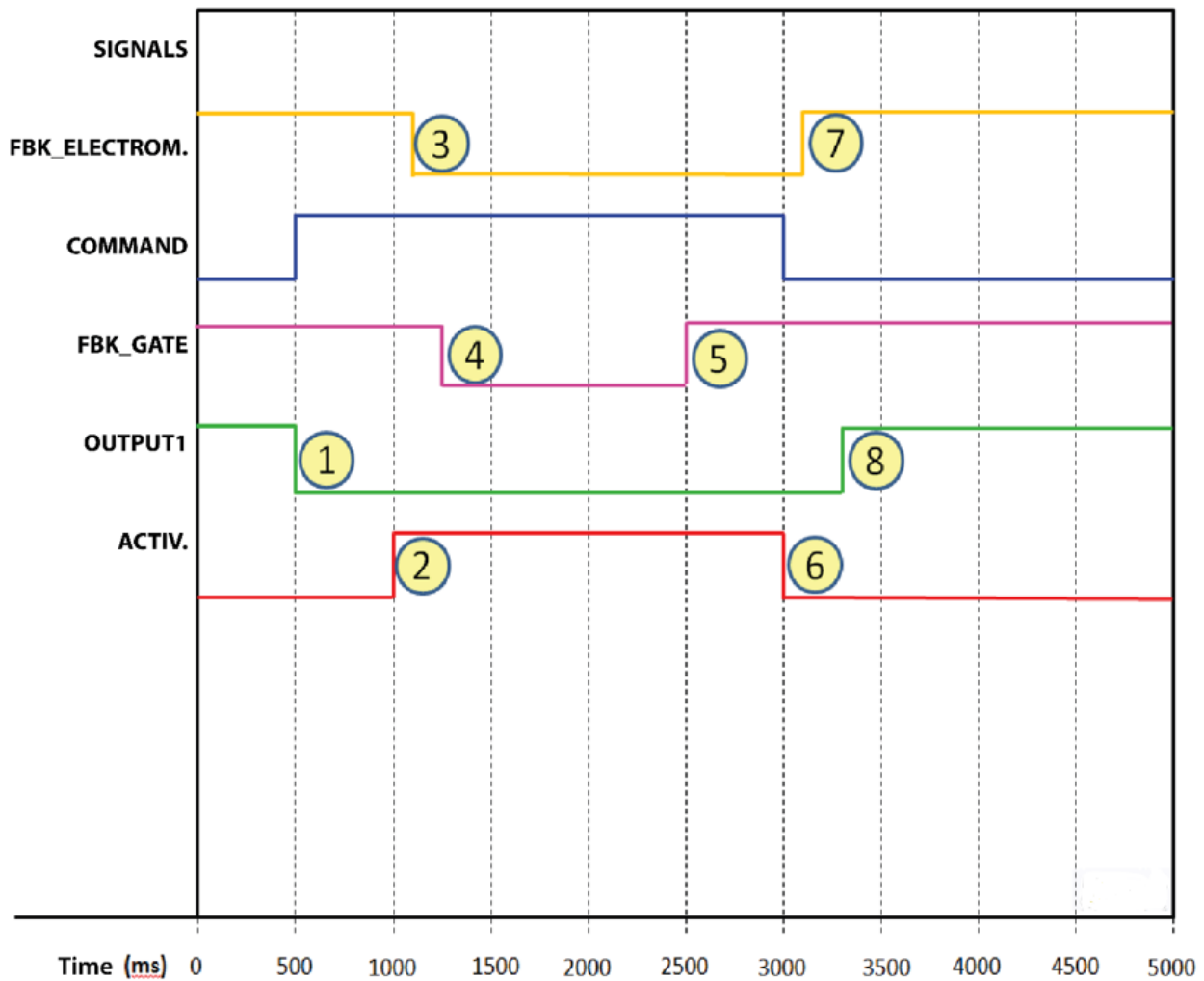

Figure 78 - Traces relative to “Guard Lock” block operation in the “Mandatory gate opening mode”.

In “Mandatory gate opening” mode, the “Guard\_lock” operator indicates an error condition if it does not detect that the gate has been opened following a request to unlock the guard lock. This concept is highlighted in the figure below (Figure 79). In this case, the “Enable Error out” option has been selected in the diagram in Figure 77, so that the error is shown in the graph.

As previously described, the operator requests unlocking of the guard lock, but the door is never opened, and this condition is indicated by the “FBK\_GATE” signal, which stays at LL1. Thus, when the guard lock unlocking/locking cycle ends, at time “E”, the “Guard\_Lock” operator switches the status of the “ERROR” signal from LL0 to LL1.

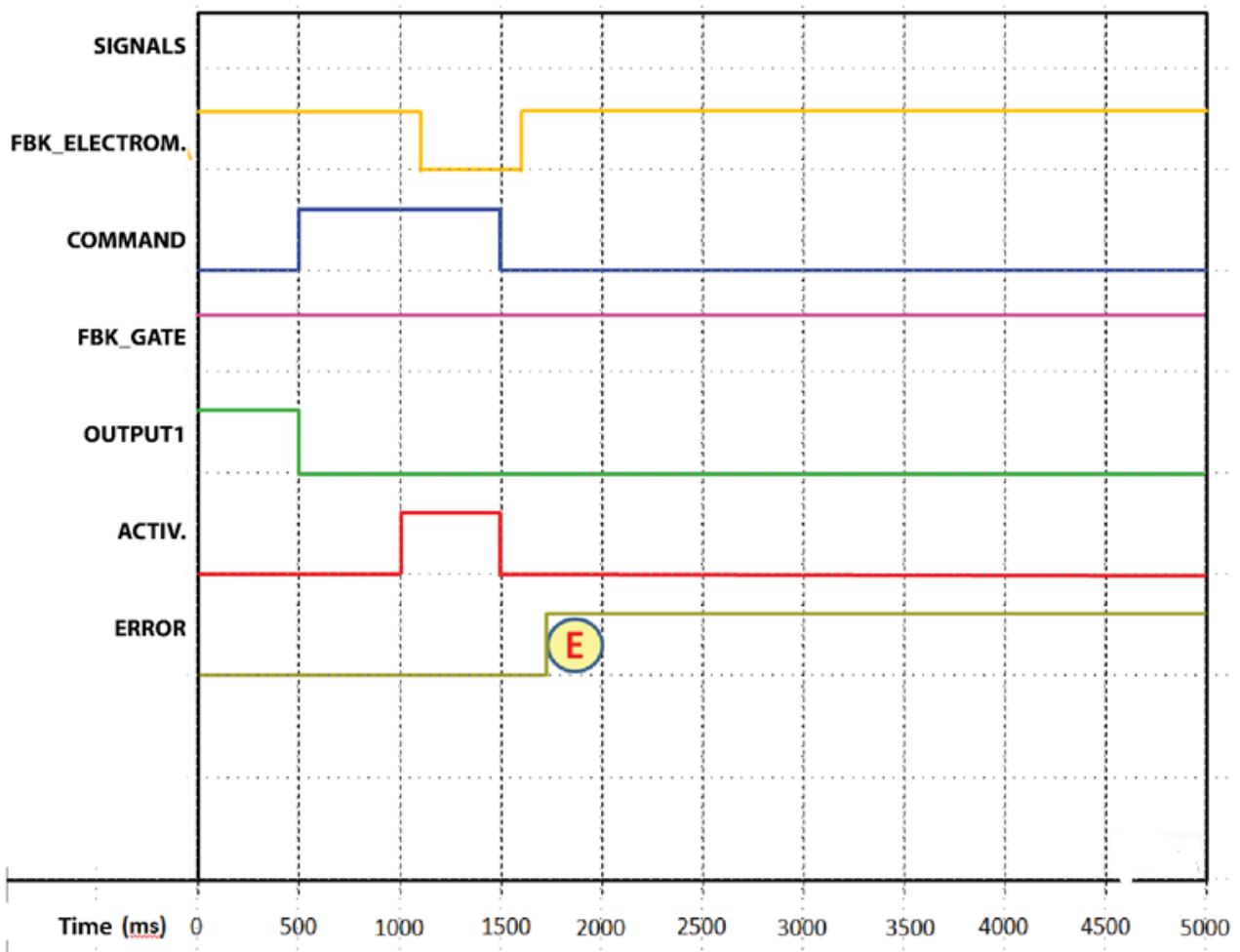
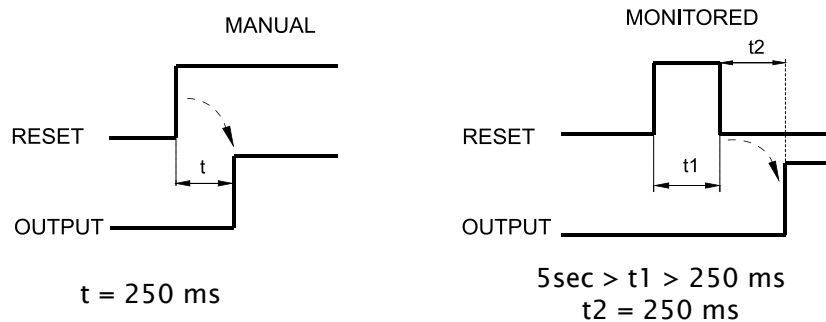

Figure 79 – Example of possible error condition in "Mandatory gate opening" mode. In this case the error condition is generated because the gate has not been opened, even though a request has been sent to unlock/lock the guard lock.

### Parameters

#### Manual Reset:

There are two types of reset: Manual and Monitored. When Manual is selected the system only verifies the signal's transition from 0 to 1. If Monitored is selected the double transition from 0 to 1 and then back to 0 is verified.



**Unlock Time (s):**

The time that must pass between the **UnLock\_cmd** input reaching and the real guard unlock (**Lockout output**).

- 0ms ÷ 1 s Step 100 ms
- 1.5 s ÷ 10 s Step 0.5 s
- 15 s ÷ 25 s Step 5 s

**Feedback Time (s):**

Maximum delay accepted between **LockOut** output and **Lock\_fbk** input (must be the one shown on the lock data sheet with appropriate gap decided by the operator).

- 10ms ÷ 100 s Step 10 ms
- 150ms ÷ 1 s Step 50 ms
- 1.5 s ÷ 3 s Step 0.5 s

**Interlock Spring:** The guard is locked passively and released actively, i.e. the mechanical force of the spring keeps it locked. *The guard thus continues to be locked even when the power supply is disconnected.*

**Mandatory gate opening:** Only with door opening and subsequent confirmation of input GATE, the cycle proceeds.

**Gate not present:** If selected, enables configuration without Gate but only with LOCK FEEDBACK (feedback coil lock).

**Enable error out:** This can be selected to enable a signal (Error Out) to indicate a lock malfunction. When Error Out = 1 (TRUE) there is a fault in the lock. (e.g. open door with guard lock locked, Feedback Time exceeding the maximum allowed, etc.).

## COUNTER OPERATORS

COUNTER operator is a pulse counter that sets output Q to 1 (TRUE) as soon as the desired count is reached.

### COUNTER (max number = 16)

The operator COUNTER is a pulse counter. There are 3 operating modes:

- 1) AUTOMATIC
- 2) MANUAL
- 3) AUTOMATIC + MANUAL

Counter value is 6 for all examples:

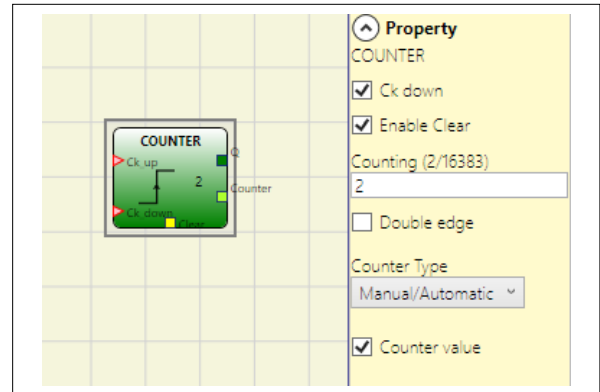

- 1) The counter generates a pulse duration equal to  $2 \times T_{cycle}$  (indicated in the REPORT) as soon as the set count is reached. If the CLEAR pin is not enabled this is the default mode.

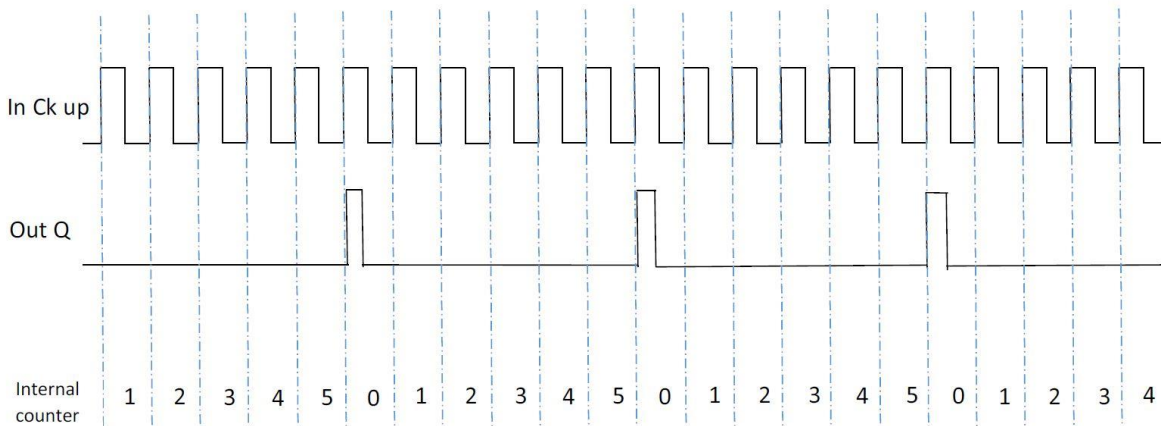

- 2) The counter leads to 1 (TRUE) the output Q as soon as it reaches the set count. The output Q goes to 0 (FALSE) when the signal CLEAR is activated.

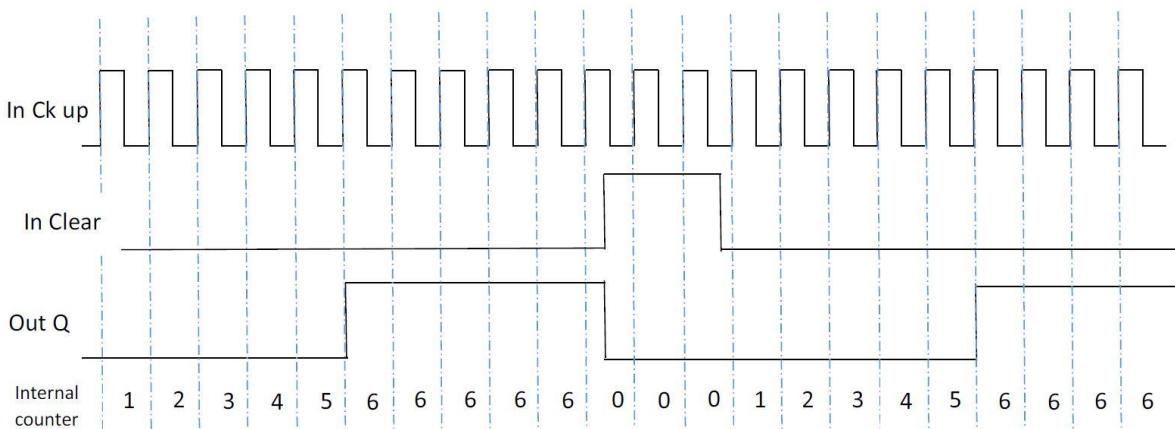

3) The counter generates a pulse duration equal to the system response time as soon as the set count is reached. If the CLEAR signal is activated, the internal count goes back to 0.

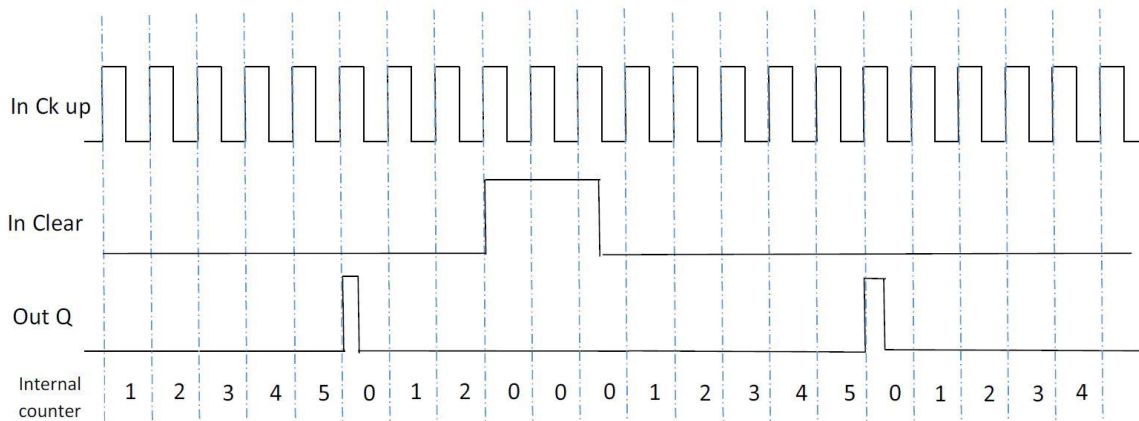

## Parameters

**Clear Enable:** If selected this enables the request to clear in order to restart the counter setting output Q to 0 (FALSE). It also offers the possibility of enabling or not enabling (*Automatic Enable*) automatic operation with manual reset.

If this is not selected operation is automatic. Once the set count is reached output Q is set to 1 (TRUE) and stays in this condition for  $2 \times T_{cycle}$  (indicated in the REPORT) after which it is reset.

**Ck down:** Enables counting down.

**Two-way:** If selected it enables counting on both the rising and falling edges.

**Counter value:** If selected, it allows the current counter value to be extracted from the delay block. This output can be sent as input to one or more COUNTER COMPARATOR blocks.

## COUNTER COMPARATOR

This operator enables to compare the value of the COUNTER connected with the set threshold value. The OUT output will be 0 (FALSE) as long as the COUNTER value is lower than the threshold value. The OUT output will be set to 1 (TRUE) for COUNTER values equal to or higher than the threshold value.

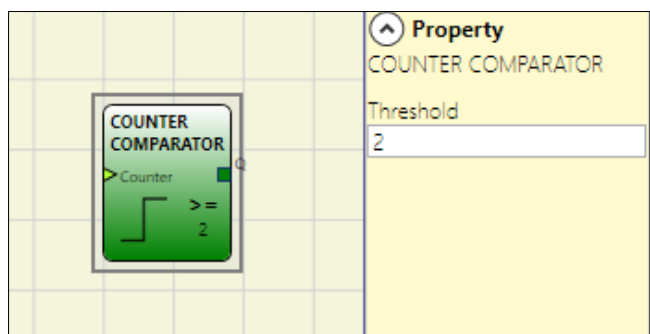

➔ The COUNTER COMPARATOR operator can only be connected to the Counter value of a COUNTER operator. Multiple COUNTER COMPARATOR can be also connected to a single COUNTER operator.

**TIMER OPERATORS (max number = 32 with M1, 48 with M1S)**

TIMER operators allow you to generate a signal (TRUE or FALSE) for a user-definable period.

**MONOSTABLE**

The MONOSTABLE operator generates a level 1 (TRUE) output activated by the rising edge of the input and remains in this condition for the set time.

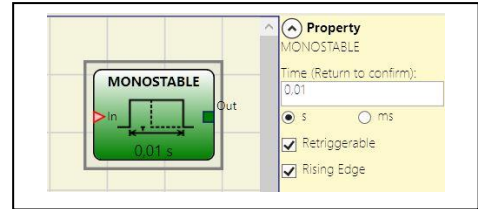

**Parameters**

*Time:* The delay can be set to between 10 ms and 1098.3 s.

*Rising edge:* If selected, the output is set to 1 (TRUE) on the input signal's rising edge where it remains for the set time, which can be extended for as long as the input stays at 1 (TRUE).

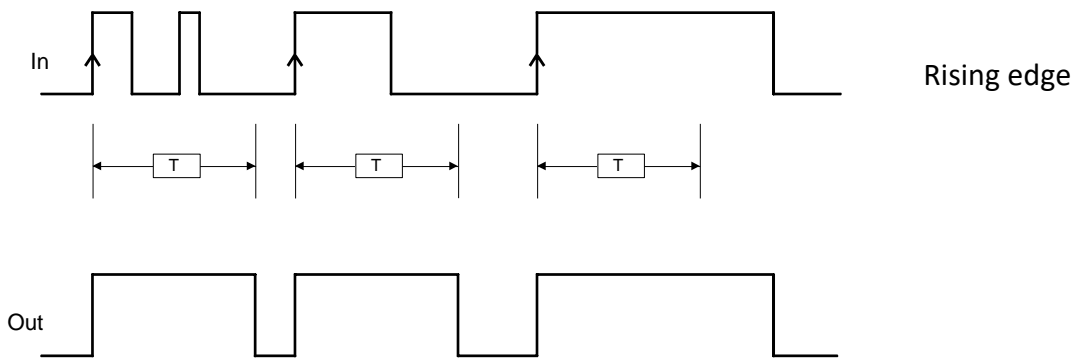

If not selected the logic is inverted, the output is set to 0 (FALSE) on the input signal's falling edge, where it remains for the set time, which can be extended for as long as the input stays at 0 (FALSE).

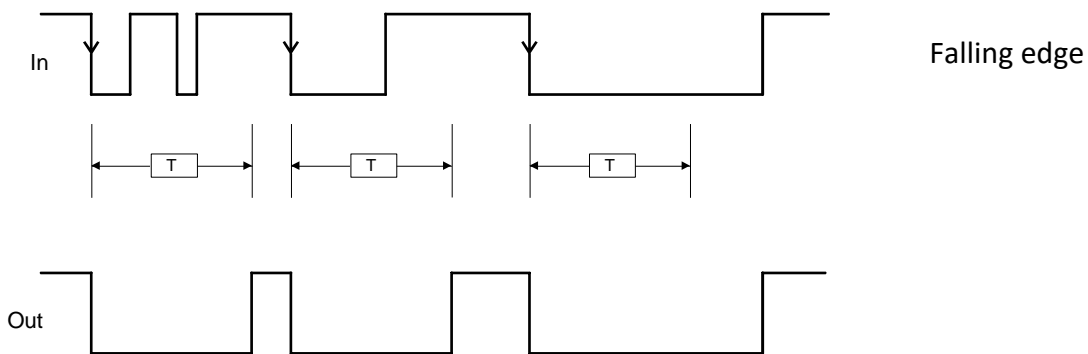

*Retriggerable:* If selected the time is reset each time the input status changes.

**MONOSTABLE\_B**

This operator generates a level 1 (TRUE) output activated by the rising/falling edge of the input and remains in this condition for the set time  $t$ .

**Parameters**

*Time:* The delay can be set to between 10 ms and 1098.3 s.

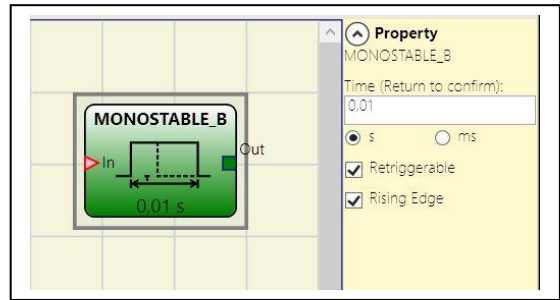

*Rising edge:*

- If selected provides a level 1 (TRUE) in the OUT output if a **rising edge** is detected on the IN input.
- If not selected the logic is inverted, the OUT output is set to 0 (FALSE) on the IN signal's falling edge, where it remains for the set time.

➔ Unlike the MONOSTABLE operator, the Out output of MONOSTABLE\_B does not maintain a level 1 (TRUE) for a time which exceeds the set period  $t$ .

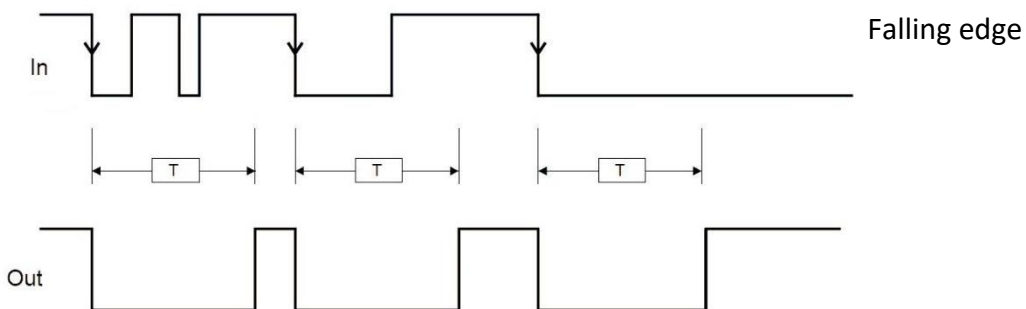
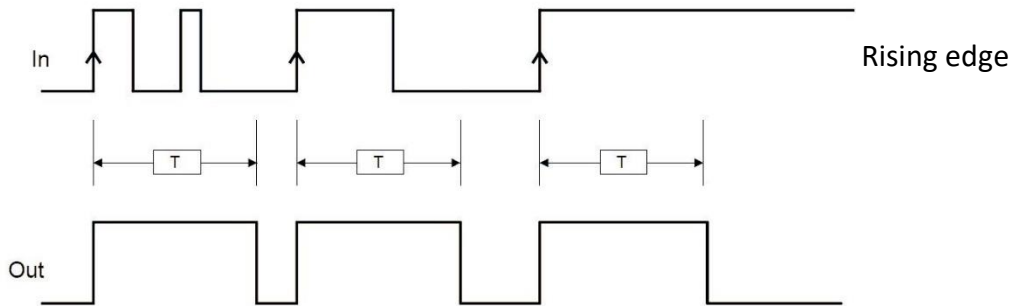

*Retriggerable:* If selected the time is reset each time the input status changes.



## PASSING MAKE CONTACT

In the PASSING MAKE CONTACT operator the output follows the signal on the input. However, if this is 1 (TRUE) for longer than the set time, the output changes to 0 (FALSE). When there is an input falling edge, the timer is cleared.

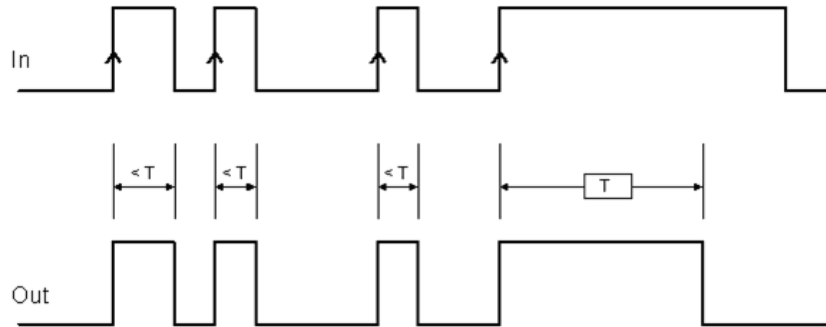
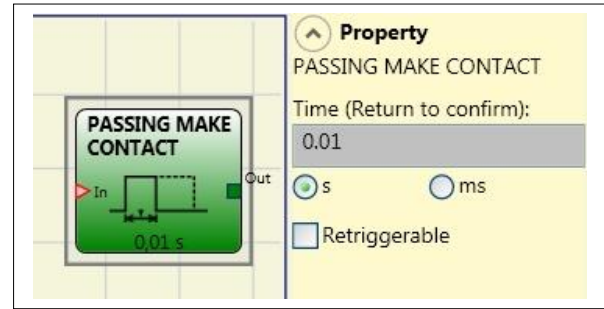

### Parameters

*Time:* The delay can be set to between **10 ms and 1098.3 s**.

*Retriggerable:* If selected the time is not reset when there is an input falling edge. The output stays 1 (TRUE) for all the selected time. When there is a new input rising edge, the timer restart again.

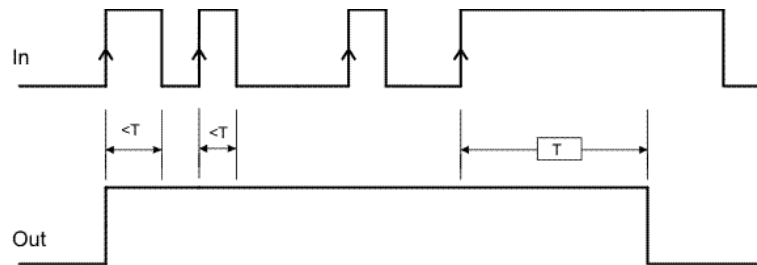

## DELAY

DELAY operator applies a delay to a signal by setting the output to 1 (TRUE) after the set time, against a change in the level of the input signal.

### Parameters

*Time:* The delay can be set to between **10 ms and 1098.3 s**.

*Rising edge:* If selected, the delay starts on the input signal's rising edge at the end of which the output changes to 1 (TRUE) if the input is 1 (TRUE) where it remains for as long as the input stays at 1 (TRUE).

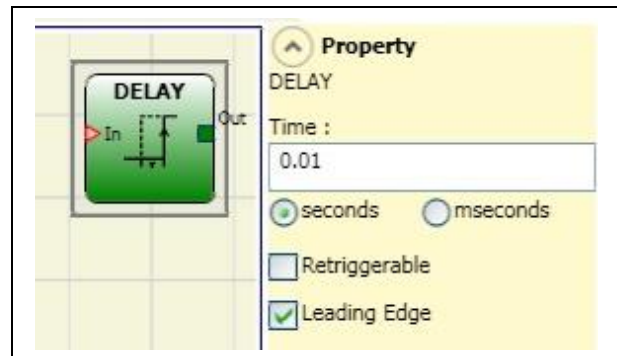

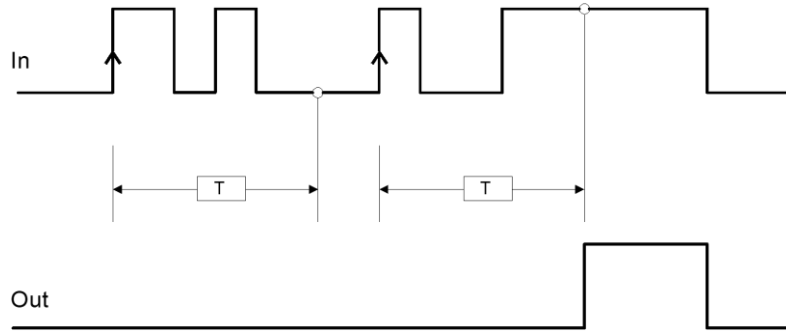

If not selected the logic is inverted, the output is set to 1 (TRUE) on the input signal's rising edge, the delay starts on the input signal's falling edge, at the end of the set time the output changes to 0 (FALSE) if the input is 0 (FALSE) otherwise it remains 1 TRUE.

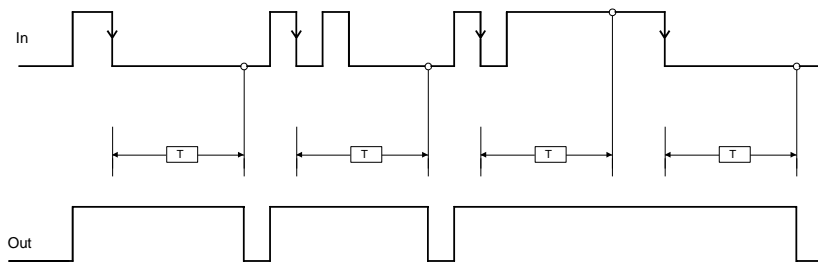

*Retriggerable:* If selected the time is reset each time the input status changes.

## LONG DELAY

The LONG DELAY operator allows to apply a delay (up to more than 15 hours) to a signal bringing to 1 (TRUE) the Out output after the set time, in case of a level variation of the signal on the In input.

### Parameters

*Time:* The delay can be set from 0.5 s to 54915 s.

*Rising edge:* If selected, the delay starts on the input signal's rising edge at the end of which the output changes to 1 (TRUE) if the input is 1 (TRUE) where it remains for as long as the input stays at 1 (TRUE).

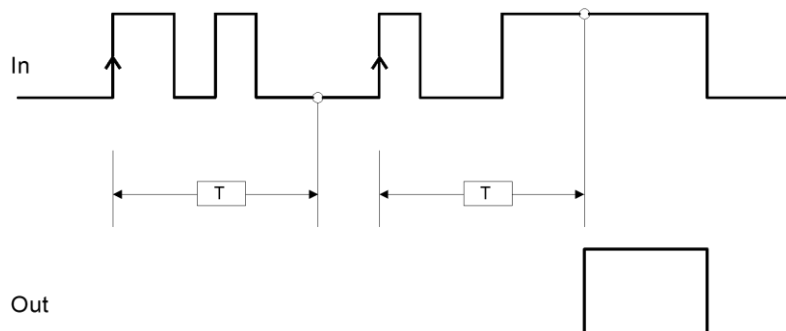

If not selected the logic is inverted, the output is set to 1 (TRUE) on the input signal's rising edge, the delay starts on the input signal's falling edge, at the end of the set time the output changes to 0 (FALSE) if the input is 0 (FALSE) otherwise it remains 1 TRUE.

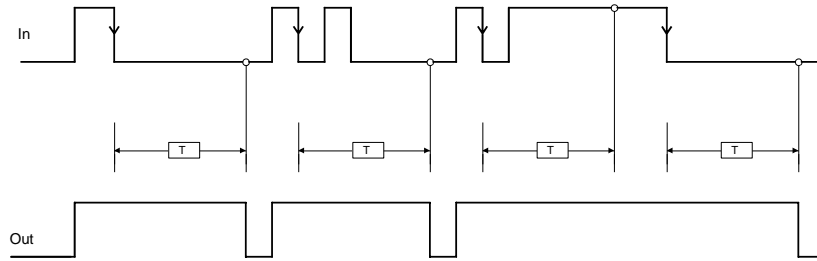

**Retriggerable:** If selected the time is resetted every time the input status changes.

**Timer value:** If selected, it allows to extract from the delay block the punctual value of the timer. This output can be sent as input to a DELAY COMPARATOR block

## DELAY COMPARATOR

This operator enables to compare the value of the LONG DELAY timer connected with the set threshold value.

The OUT output will be 0 (FALSE) as long as the timer value is lower than the threshold value. The OUT output will be set to 1 (TRUE) for Timer values equal to or higher than the threshold value.

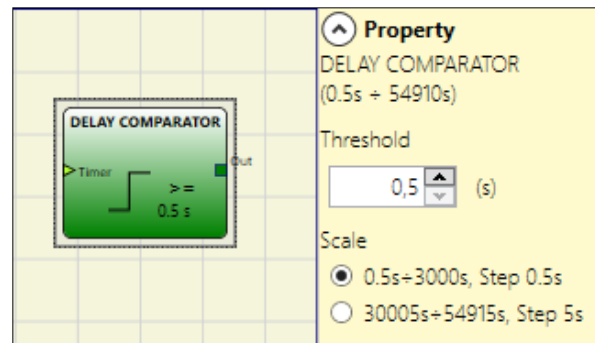

➔ The Delay Comparator operator can only be connected to the Timer value output of a LONG DELAY operator. Multiple DELAY COMPARATORS can be connected to each LONG DELAY operator.

## DELAY LINE

This operator applies a delay to a signal by setting the OUT output to 0 after the set time, set at a falling edge of the IN signal.

If IN returns to 1 before the end of the set time, the OUT output still generates an LLO impulse lasting approximately twice the response time and delayed by the set time.

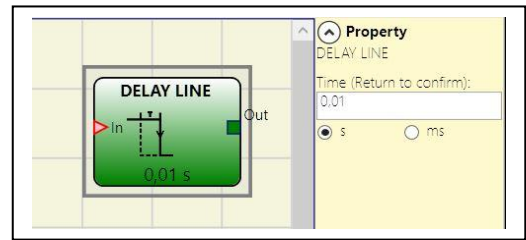

### Parameters

**Time:** Enables the insertion of the desired delay time by selecting the preferred unit of measurement. The delay can be set to between 10 ms and 1098.3 s.

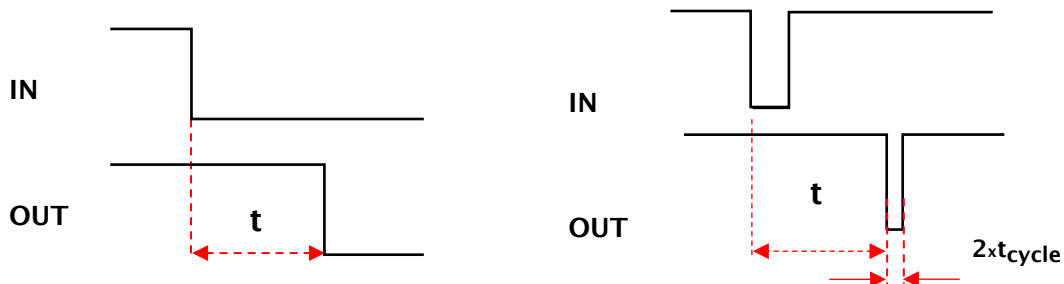

- ➔ Unlike the DELAY operator, the DELAY LINE operator does not filter any interruptions in the IN input which are shorter than the set time.
- ➔ This operator is recommended when using delayed OSSD (the OSSD must be programmed with RESTART MANUAL).

## LONG DELAY LINE

This operator inserts a delay to a signal bringing the OUT output to 0 after the time set in the event of an IN signal descent.

If before the set time has elapsed IN returns to 1, the OUT output still generates a 0 level pulse, which lasts approximately 2 times the response time and is delayed by the set time.

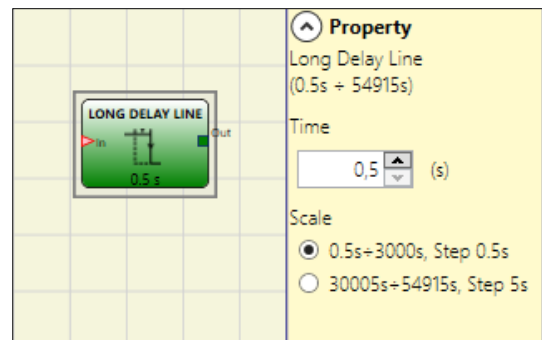

### Parameters

**Time:** It enables to select the desired delay time. The delay can be set from 0.5 s to 54915 s.

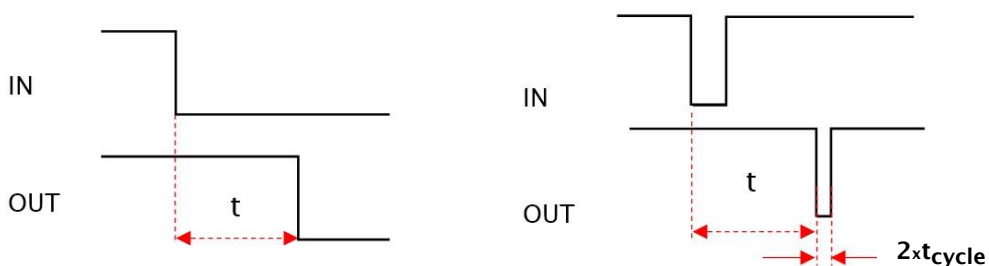

Unlike the DELAY operator, the LONG DELAY LINE operator does not filter out any interruptions to the IN input that are shorter than the set time.

This operator is indicated when using delayed OSSDs (the OSSD must be programmed with MANUAL RESTART).

## CLOCKING

The CLOCKING operator generates a clock signal output with the set period if the IN input is 1 (TRUE). Clocking has up to 7 inputs to control output Duty Cycle.

### Parameters

**Time:** The period can be set to between 10 ms and 1098.3 s.

**Duty cycle selection:** Up to 7 inputs can be selected for 7 different output signal duty cycles.

Depending on the active input, the OUT clock signal has its corresponding duty cycle. EN input must always be high level (TRUE).

Refer to the table below to check operator functioning.

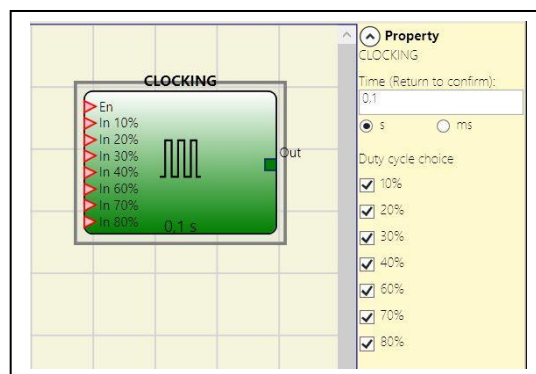

DUTY CYCLE CHOICE								
EN	10%	20%	30%	40%	60%	70%	80%	OUT
0	0	0	0	0	0	0	0	0
1	0	0	0	0	0	0	0	50%
1	1	0	0	0	0	0	0	10%
1	0	1	0	0	0	0	0	20%
1	0	0	1	0	0	0	0	30%
1	0	0	0	1	0	0	0	40%
1	0	0	0	0	1	0	0	60%
1	0	0	0	0	0	1	0	70%
1	0	0	0	0	0	0	1	80%
1	1	0	0	0	0	0	1	90%

- ➔ The circuit upstream of the CLOCKING operator must guarantee the presence of a single input signal other than the EN enable (apart from the pair 10% 80%).
- ➔ The presence of the EN input together with > 1 high level (TRUE) inputs, generates an output signal with a duty cycle = 50%.

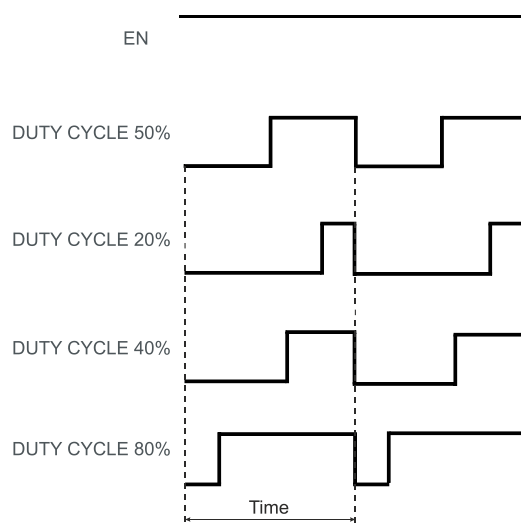

## MUTING FUNCTION

The Muting function generates a temporary, automatic interruption of safety device operation in order to permit normal transit of material through the guarded opening. In other words, when the system recognizes the material and distinguishes between this and any operator (in a potentially dangerous situation), it is enabled to bypass the safety device temporarily, allowing the material to pass through the guarded opening.

### MUTING OPERATORS (max number = 4 with M1, 8 with M1S)

#### "Concurrent" MUTING

The activation of the Muting function occurs following interruption of the sensors S1 and S2 beam (the order does not matter) within a time range from 2s and 5s decided by the operator (or S3 and S4 with material that is moving in the direction opposite).

The MUTING operator with "Concurrent" logic performs muting of the input signal through sensor inputs S1, S2, S3 and S4.

➔ Preliminary condition: The Muting cycle can only start if all the sensors are 0 (FALSE) and inputs are 1 (TRUE) (barrier free).

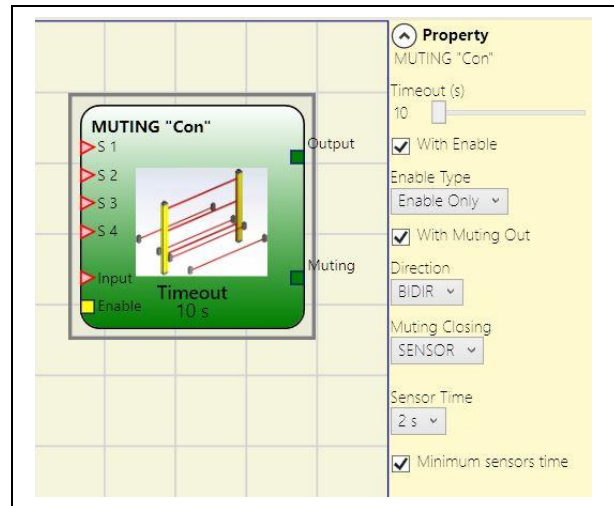

#### Parameters

**Timeout (sec):** Sets the time, between 10 secs and unlimited, within which the Muting cycle must end. If the cycle is not complete at the end of this time, Muting is immediately discontinued.

**Enable:** If selected it enables the possibility of enabling or not enabling the Muting function. Otherwise the Muting function is always enabled.

There are two Enable modes: Enable/Disable and Enable Only. If Enable/Disable is selected the Muting cycle cannot start if Enable is fixed at 1 (TRUE) or 0 (FALSE) but is only activated with a rising edge. To disable muting, set Enable to 0 (FALSE). In this mode the falling edge disables Muting regardless of the condition. If Enable Only is selected Muting cannot be disabled but Enable must be set to 0 (FALSE) in order to enable a new rising edge for the next Muting cycle.

**Direction:** The order in which the sensors are occupied can be set. If set to BIDIR they can be occupied in both directions, from S1&S2 to S3&S4 and from S3&S4 to S1&S2, if set to UP they can be occupied from S1&S2 to S3&S4 and if set to DOWN from S3&S4 to S1&S2.

**Muting Close:** There are two types, CURTAIN and SENSOR. If you select CURTAIN muting closes when the input signal rises, if you select SENSOR it closes when the third sensor has been cleared.

Select CURTAIN

S1	S2	Input	S3	S4	Muting
0	0	1	0	0	0
1	0	1	0	0	0
1	1	1	0	0	1
1	1	X	0	0	1
1	1	X	1	1	1
0	0	0	1	1	1
0	0	1	1	1	0
0	0	1	0	0	0

Muting active

Select SENSOR

S1	S2	Input	S3	S4	Muting
0	0	1	0	0	0
1	0	1	0	0	0
1	1	1	0	0	1
1	1	X	0	0	1
1	1	X	1	1	1
0	0	0	1	1	1
0	0	1	1	1	1
0	0	1	0	1	0
0	0	1	0	0	0

Muting active

**Blind Time:** *Only with Muting Close=Curtain*, blind time is enabled if you know that after the complete transition of the pallet (muting cycle close) some protruding objects could still occupy the light curtain and send the input to 0 (FALSE). During blind time the input remains 1 (TRUE). Blind Time can range from 250 msecs to 1 second.

**Sensors Time:** Sets the *maximum time* (between 2 and 5 seconds) between activating two muting sensors.

**Minimum sensors time:** If selected, allows the activation of Muting cycle only if a time  $\geq 150$ ms elaps between the activation of the sensor 1 and sensor 2 (or sensor 4 and 3).

MUTING "L"

The activation of the Muting function occurs following interruption of the sensors S1 and S2 beam (the order does not matter) within a time range from 2s and 5s decided by the operator. The state of the Muting ends after the liberation of the guarded opening.

The MUTING operator with "L" logic performs muting of the input signal through sensor inputs S1 and S2.

➔ Preliminary condition: The Muting cycle can only start if S1 and S2 are 0 (FALSE) and the inputs are 1 (TRUE) (barrier free).

Parameters

**Timeout (sec):** Sets the time, between 10 secs and unlimited, within which the Muting cycle must end. If the cycle is not complete at the end of this time, Muting is immediately discontinued.

**Enable:** If selected it enables the possibility of enabling or not enabling the Muting function. Otherwise the Muting function is always enabled.

There are two Enable modes: Enable/Disable and Enable Only. If Enable/Disable is selected the Muting cycle cannot start if Enable is fixed at 1 (TRUE) or 0 (FALSE) but is only activated with a rising edge. To disable muting, set Enable to 0 (FALSE). In this mode the falling edge disables Muting regardless of the condition. If Enable Only is selected Muting cannot be disabled but Enable must be set to 0 (FALSE) in order to enable a new rising edge for the next Muting cycle.

**Sensors Time:** Sets the *maximum time* (between 2 and 5 seconds) between activating two muting sensors.

**End of Muting time:** sets the maximum time (from 2.5 to 6 seconds) that must elapse between the release of the first sensor and the release of guarded opening. The end of this time determines the end of the Muting function.

**Blind Time:** enabled if you know that after the complete transition of the pallet (muting cycle close) some protruding objects could still occupy the light curtain and send the input to 0 (FALSE). During blind time the input remains 1 (TRUE). Blind Time can range from 250 msec to 1 second.

## "Sequential" MUTING

The activation of the Muting function occurs following sequential interruption of the sensors S1 and S2, subsequently S3 and S4 sensors (without time limit). If the pallet proceeds in the opposite direction the correct sequence is: S4, S3, S2, S1.

The MUTING operator with "Sequential" logic performs muting of the input signal through sensor inputs S1, S2, S3 and S4.

➔ Preliminary condition: The Muting cycle can only start if all the sensors are 0 (FALSE) and the inputs are 1 (TRUE) (barrier free).

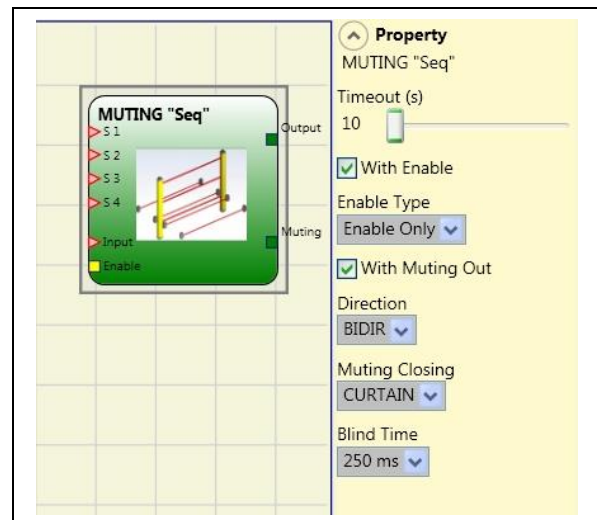

## Parameters

**Timeout (sec):** Sets the time, between 10 secs and unlimited, within which the Muting cycle must end. If the cycle is not complete at the end of this time, Muting is immediately discontinued.

**Enable:** If selected it enables the possibility of enabling or not enabling the Muting function. Otherwise the Muting function is always enabled.

There are two Enable modes: Enable/Disable and Enable Only. If Enable/Disable is selected the Muting cycle cannot start if Enable is fixed at 1 (TRUE) or 0 (FALSE) but is only activated with a rising edge. To disable muting, set Enable to 0 (FALSE). In this mode the falling edge disables Muting regardless of the condition. If Enable Only is selected Muting cannot be disabled but Enable must be set to 0 (FALSE) in order to enable a new rising edge for the next Muting cycle.

**Direction:** The order in which the sensors are occupied can be set. If set to BIDIR they can be occupied in both directions, from S1 to S4 and from S4 to S1, if set to UP they can be occupied from S1 to S4 and if set to DOWN from S4 to S1.



**Muting Close:** There are two types, CURTAIN and SENSOR. If you select CURTAIN muting closes when the input signal rises, if you select SENSOR it closes when the third sensor has been cleared.

Select CURTAIN

S1	S2	Input	S3	S4	Muting
0	0	1	0	0	0
1	0	1	0	0	0
1	1	1	0	0	1
1	1	X	0	0	1
1	1	X	1	0	1
1	1	X	1	1	1
0	1	X	1	1	1
0	0	0	1	1	1
0	0	1	1	1	0
0	0	1	0	1	0
0	0	1	0	0	0

Muting active

Select SENSOR

S1	S2	Input	S3	S4	Muting
0	0	1	0	0	0
1	0	1	0	0	0
1	1	1	0	0	1
1	1	X	0	0	1
1	1	X	1	0	1
1	1	X	1	1	1
0	1	X	1	1	1
0	0	0	1	1	1
0	0	1	1	1	1
0	0	1	0	1	0
0	0	1	0	0	0

Muting active

**Blind Time:** **Only with Muting Close=Curtain**, blind time is enabled if you know that after the complete transition of the pallet (muting cycle close) some protruding objects could still occupy the light curtain and send the input to 0 (FALSE). During blind time the input remains 1 (TRUE). Blind Time can range from 250 msec to 1 second.

MUTING "T"

The activation of the Muting function occurs following interruption of the sensors S1 and S2 beam (the order does not matter) within a time range from 2s and 5s decided by the operator. The state of the Muting ends after the liberation of at least one of the two sensors.

The MUTING operator with "T" logic performs muting of the input signal through sensor inputs S1 and S2.

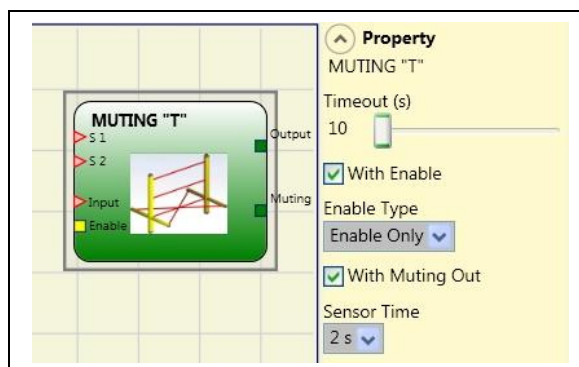

➔ Preliminary condition: The Muting cycle can only start if S1 and S2 are 0 (FALSE) and the inputs are 1 (TRUE) (barrier free).

## Parameters

**Timeout (sec):** Sets the time, between 10 secs and unlimited, within which the Muting cycle must end. If the cycle is not complete at the end of this time, Muting is immediately discontinued.

**Enable:** If selected it enables the possibility of enabling or not enabling the Muting function. Otherwise the Muting function is always enabled.

There are two Enable modes: Enable/Disable and Enable Only. If Enable/Disable is selected the Muting cycle cannot start if Enable is fixed at 1 (TRUE) or 0 (FALSE) but is only activated with a rising edge. To disable muting, set Enable to 0 (FALSE). In this mode the falling edge disables Muting regardless of the condition. If Enable Only is selected Muting cannot be disabled but Enable must be set to 0 (FALSE) in order to enable a new rising edge for the next Muting cycle.

**Sensors Time:** Sets the **maximum time** (between 2 and 5 seconds) between activating two muting sensors.

## MUTING OVERRIDE (max number = 4)

*The OVERRIDE function must be used when the machine stops due to incorrect Muting activation sequences with the material obstructing the guarded opening. This function activates the OSSD outputs making it possible to remove the material that is obstructing the guarded opening.*

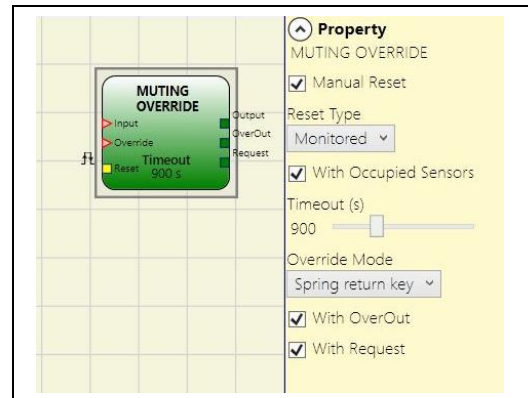

The operator must be connected after the Muting operator (Muting OUTPUT directly to the Override INPUT).

The operator permits override of the directly connected Muting Input.

Override can be activated only if Muting is not active (INPUT=0) and at least one Muting sensor is occupied (or the light curtain is occupied).

Override ends when the light curtain and sensors are cleared and the OverOut switches to logical "0" (FALSE).

Override can be set to pulsed or maintained action mode.

### **Override with maintained action control.**

This function must be activated maintaining the Override command active (OVERRIDE=1) during all subsequent operations. However, a new Override can be activated, de-activating and re-activating the command.

When the light curtain and sensors are cleared (gap free) or on expiry of the timeout, Override ends without the need for further commands.

### **Override with pulsed action**

This function is enabled activating the Override command (OVERRIDE=1).

Override ends when the light curtain and sensors are cleared (gap free) or on expiry of the timeout. The function can be restarted only if the Override command is re-activated (OVERRIDE=1).

## Parameters

**With sensors occupied:** Must be selected with "T" sequential, simultaneous muting; with "L" muting, must not be selected.

- ➔ Otherwise, a Warning is displayed in the compilation phase and in the report.
- ➔ The user must adopt additional safety measures during the Override phase.

Conditions to be checked for activation of Override

"With sensors occupied " selected	sensor occupied	light curtain occupied	Input	Override request	Override output
X	X	-	0	1	1
-	-	X	0	1	1
	X	-	0	1	1
	X	X	0	1	1

*Timeout (sec):* Used to set the time, between 10 sec and infinity, by which the Override function must end.

*Override mode:* Used to configure the type of Override (pulsed or maintained action).

*With OverOut:* Used to activate an Override active Signaling output (active when high).

*With Request:* Used to activate a Signaling output (active when high) indicating that the Override function can be activated.

*Manual Reset:*

- Should the INPUT be active (TRUE), the reset enables the output of the function block.
- Should the INPUT be not active (FALSE), the output of the function block follows the OVERRIDE request.

There are two types of reset: Manual and Monitored. When Manual is selected the system only verifies the signal's transition from 0 to 1. If Monitored is selected the double transition from 0 to 1 and then back to 0 is verified.

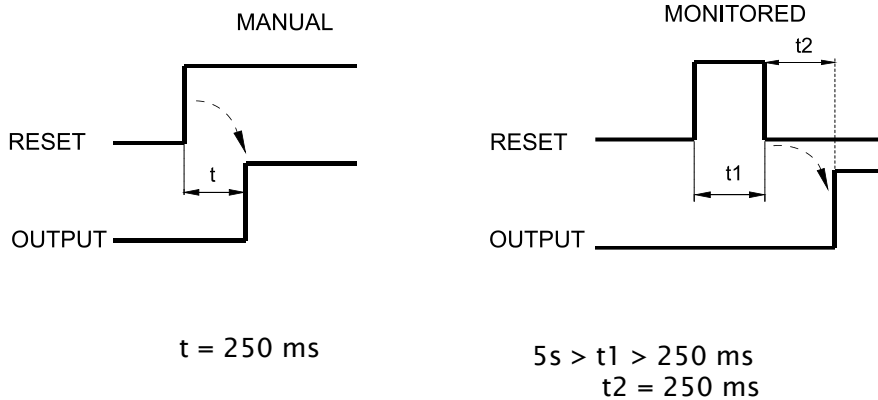

**ANALOG OPERATORS (M1S only)**

**Analog Comparator**

This operator works as a comparator of an analog signal connected.

The threshold value to be entered will be in engineering units (eg Kg, °C) and must respect the limits defined by the functional block connected at the “Analog” input.

When the input value is lower than the threshold, the output Q will be at level 0 (FALSE).

When the input value is equal or greater than to the threshold, the output Q will be at level 1 (TRUE).

The “Analog” input can be connected to:

- the analogue output of an “ANALOG COMPARISON” input block
- the analogue output of an “ADDER” block.

The hysteresis used in the comparison will be the one programmed in the functional block connected upstream.

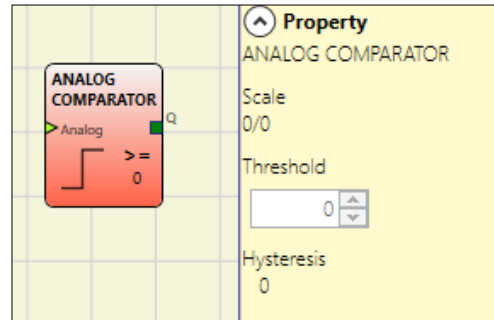

**Adder (max number = 16)**

The ADDER operator performs the sum (or the difference) between analog signals coming from an ANALOG INPUT blocks.

The signals must have the same physical unit and must be generated by sensors of the same type (4/20mA, 0/20mA or 0/10V) but they can have different scales.

**Parameters**

*Input number:*

**Sum:** it’s possible to sum from 2 to 8 signals.

**Difference:** it’s possible to perform difference of 2 signals.

*Operation:*

**Sum:** The result will be the sum of all the inputs and will be provided as a physical unit.

**Difference:** The result of the operation will be the absolute value of the difference |(Ain1 - Ain2)| with relative sign (exit Sign).

The Sign output will be at 0 (FALSE) if the sign of the difference is positive, while it will be at 1 (TRUE) if the sign is negative.

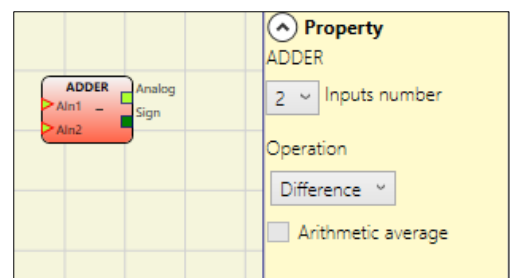
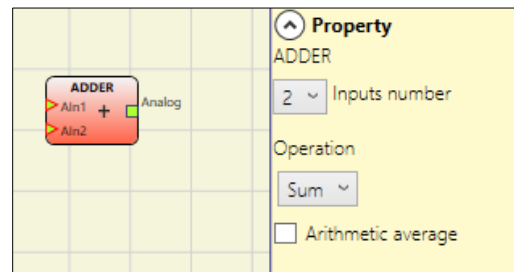

**Arithmetic average:**

Setting Arithmetic Average box with Operation as Sum, the output value of this operator will be the arithmetic average of the various inputs.

## Equality check (max number = 16)

This operator checks if two analog inputs are equal within a selectable value.

The signals must have the same physical unit and must be generated by sensors of the same type (4/20mA, 0/20mA or 0/10V) but they can have different scales.

The output Q will be 1 (TRUE) when the condition of equality is verified. If the two signals are different, the Q output will be 0 (FALSE).

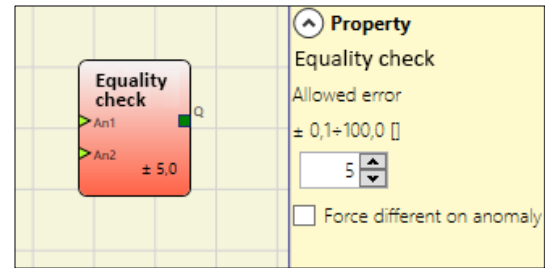

### Parameters

#### Allowed error:

Corresponds to the maximum tolerance between the difference of the values AN1 and AN2.

#### Force different on anomaly:

If checked and in presence of the connected analog input's anomaly (the analogue value assumes a full scale value), the output of the block will remain at 0 (FALSE) **as in the presence of different signals.**

## MISCELLANEOUS FUNCTION BLOCKS

### SERIAL OUTPUT (max number = 4 with M1, 8 with M1S)

The **Serial Output** operator outputs the status of up to 8 inputs, serialising the information.

#### Operating principles.

This operator outputs the status of all the connected inputs in two different ways:

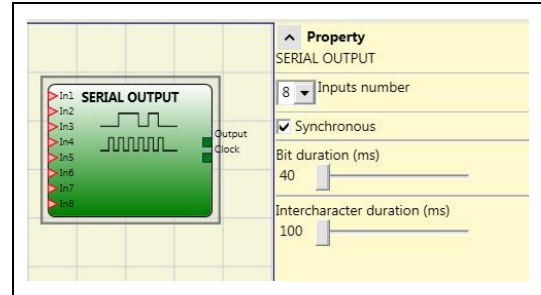

#### Asynchronous serialisation:

- 1) The status of the line in the idle condition is 1 (TRUE);
- 2) The start data transmission signal is 1 bit = (FALSE);
- 3) Transmission of  $n$  bits with the status of the connected inputs encoded using the *Manchester* method:
  - Status 0: rising edge of the signal at the centre of the bit
  - Status 1: falling edge of the signal at the centre of the bit
- 4) Intercharacter interval is 1 (TRUE) to allow synchronisation of an external device.

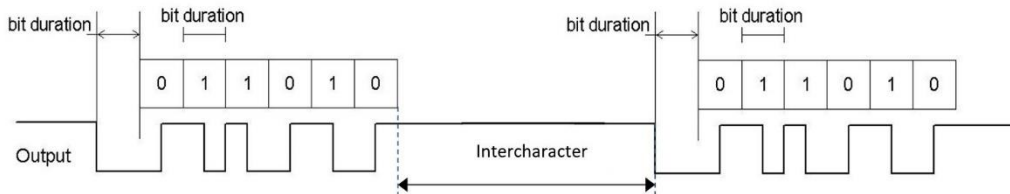

Therefore, with the Asynchronous method the *Clock* output is not present.

#### Synchronous serialisation:

- 1) The output and the clock in the idle condition are 0 (FALSE);
- 2) Transmission of  $n$  bits with the input status using OUTPUT as data, CLOCK as the timing base;
- 3) Intercharacter interval is 0 (FALSE) to allow synchronisation of an external device.

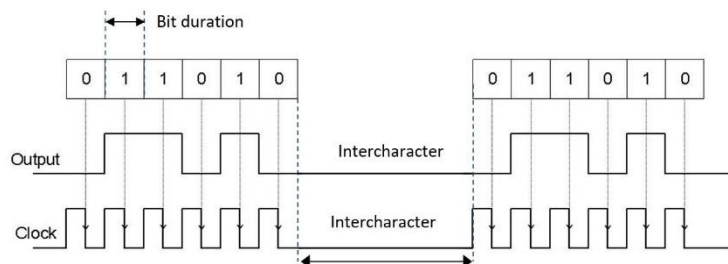

### Parameters

**Number of inputs:** Defines the number of inputs of the function block, which may be 2÷8 (*asynchronous*) or 3÷8 (*synchronous*).

**Bit length (ms):** Enter the value corresponding to the length of each single bit (input  $n$ ) in the pulse train that makes up the transmission.

- 40 ms ÷ 200 ms (Step 10 ms)
- 250 ms ÷ 0.95 s (Step 50 ms)

**Intercharacter interval (ms):** Enter the time that must pass between the transmission of one pulse train and the next.

- 100 ms ÷ 2.5 s (Step 100 ms)
- 3 s ÷ 6 s (Step 500 ms)

## NETWORK (max number = 1)

The **Network** operator is used to distribute Stop and Reset commands via a simple local network. Use **Network\_in** and **Network\_out** to exchange **START**, **STOP** and **RUN** signals between the different nodes.

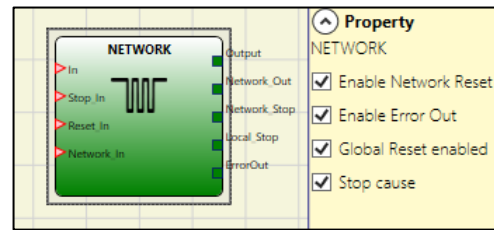

### Operating principles.

This operator allows stop and reset commands to be distributed simply in a local DSC network.

The Network operator requires the following:

- 1) the **Network\_In** input connected to a single or double input must be connected to the **Network\_Out** output of the preceding unit in the local network.
- 2) the **Network\_Out** output connected to a STATUS signal or OSSD output, must be connected to the **Network\_in** input of the next unit in the local network.
- 3) the **Stop\_In** and **Reset\_In** inputs must be connected to input devices that act as Stop (e.g. E-STOP) and Reset (e.g. SWITCH), respectively.
- 4) the **In** input can be connected freely in the diagram (e.g. input function blocks or results of logical combinations).
- 5) **Output** can be connected freely in the diagram. **Output** is 1 (TRUE) when the IN input is 1 (TRUE) and the function block has been restarted.

### Parameters

**Enable Reset Network:** when selected this allows the distribution network to reset the function block. If not enabled, the function block can only be reset via the local **Reset\_In** input.

**Enable error out:** if selected, it enables the **Error\_Out** output that can be used to signal, with a logic 1, the presence of a failure.

**Global Reset Enable:** if selected, the operator can restart the entire system with the reset button from any node in the network. If deselected the operator can restart all the nodes **that have been not caused the stop** from anywhere in the network, except the node that has caused the stop (this node has to be restarted with its own reset).

**Stop cause:** (only M1S) if selected, it enables the **Network\_stop** and **Local\_stop** outputs and indicates the cause of the STOP status. These outputs are normally at 0 with the system in RUN and the Output at 1. If a network stop is requested, the Network\_stop output increases to 1. If the Output output goes to 0 due to the In input or the Stop\_in input, the Local\_stop output goes to 1. The outputs will remain in this status until the next main reset.

- The RESET commands must be installed outside all the danger areas of the network in positions where the danger areas and the entire work areas are clearly visible.
- The maximum number of MASTER modules that can be connected in network configuration is equal to 10.
- Each Master module can have a maximum of 9 expansion modules connected.

### Condition 1:

With reference to the Figure 82 and Figure 83, at power-on:

1. The Net\_out of the various nodes are in the 0 (FALSE) condition;
2. The STOP signal is sent via the Net\_out line;
3. When the RESET command is pressed on one of the nodes all the nodes that are present are started when the START signal is sent;
4. As the end result, the Net\_out of all the connected nodes is in condition 1 (TRUE) if the various Net\_in inputs are in condition 1 (TRUE);
5. The RUN signal is sent via the network of the 4 nodes present.

**Condition 2:**

With reference to the Figure 82 and Figure 83, when the emergency stop is pressed in one of the four nodes:

1. The Net\_out moves to condition 0 (FALSE);
2. The STOP signal is sent via the Net\_out line;
3. The next node receives the stop code and deactivates the output;
4. The stop command generates the stop code for all Net\_in and Net\_out lines;
5. As the end result, the Net\_out of all the connected nodes is in condition 0 (FALSE).
6. When the emergency stop is restored to the normal position, all the nodes can be restarted by sending the START signal with a single reset. The latter condition does not occur when ENABLE RESET NETWORK is not enabled. In that case, the local reset method must be used. The system will employ about 4s to restore all the outputs of the blocks that make up the network.

➔ Perform a local reset of the module which caused the network shutdown, to restore its safety output.

Response Time

The max response time of the network starting from emergency stop is given by the formula:

$$t_r = [(212 \text{ ms} \times n^{\circ}\text{Master}) - 260\text{ms}]$$

⚠ The max number of connected Master must be 10.

Emergency Stop Pressing	MASTER n°1	MASTER n°2	MASTER n°3	MASTER n°4
	$t_{r\text{MASTER}1}$	$t_{r\text{MASTER}2}$	$t_{r\text{MASTER}3}$	$t_{r\text{MASTER}4}$
	12,6ms	164ms	376ms	488ms

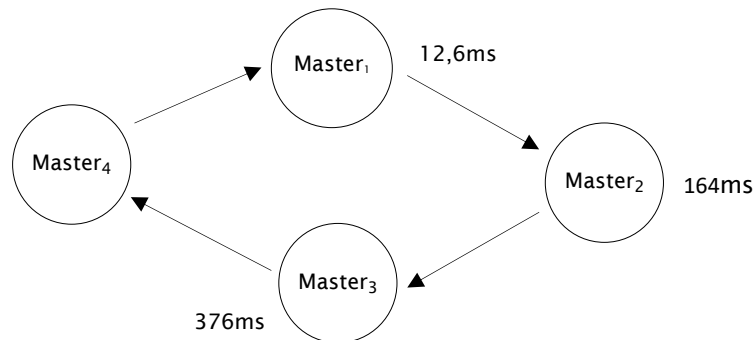

**Condition 3:**

With reference to the Figure 80 and Figure 81, when the IN input of the NETWORK function block of one of the 4 nodes moves to condition 0 (FALSE):

1. The local OUTPUT moves to condition 0 (FALSE);
2. The RUN signal continues to be sent via the Network\_out lines;
3. The states of the remaining nodes remain unchanged;
4. In that case, local reset must be used. The Reset-in LED flashes to indicate this condition. This condition is signaled by the corresponding LED flashing Reset\_In entrance.  
The affected node will be restarted with its own reset (if 'Reset Global Reset' is not selected).

The Network\_in input and the Network\_out output can only be mapped to the I/O pins of the MASTER.



Master M1 signals with Network operative

		NETWORK FUNCTIONAL BLOCK SIGNALS				
		Network in		Network out (OSSD)	Network out (STATUS)	Reset in
LED		FAIL EXT	IN (1)	OSSD (2)	STATUS	IN (3)
STATUS	STOP	OFF	OFF	RED	OFF	OFF
	CLEAR	OFF	BLINKING	RED/GREEN (BLINKING)	BLINKING	BLINKING
	RUN	OFF	ON	GREEN	ON	ON
	FAIL	ON	BLINKING	-	-	-

(1) Corresponding to the input where is wired Network IN  
 (2) Corresponding to the input where is wired Network OUT  
 (3) Corresponding to the input where is wired Reset IN

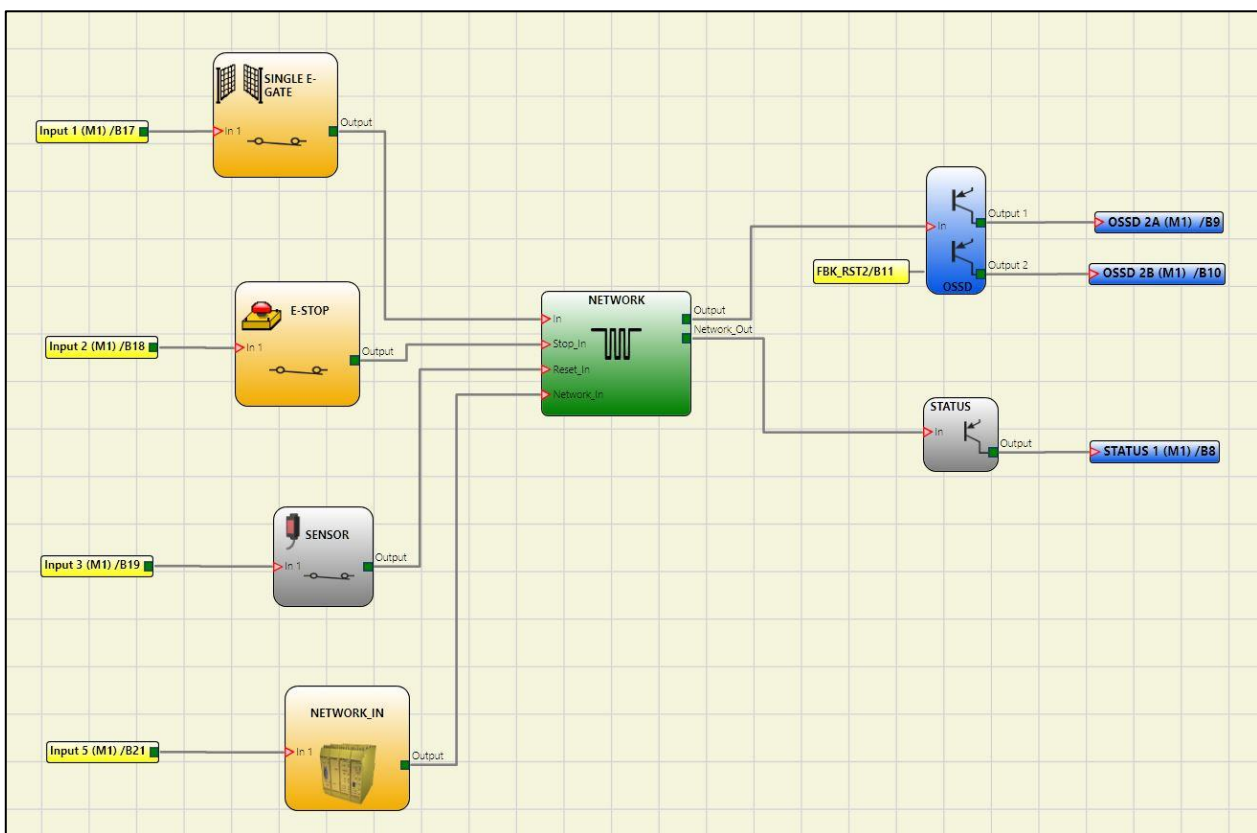

Figure 80 - NETWORK function block scheme example (Category 2)

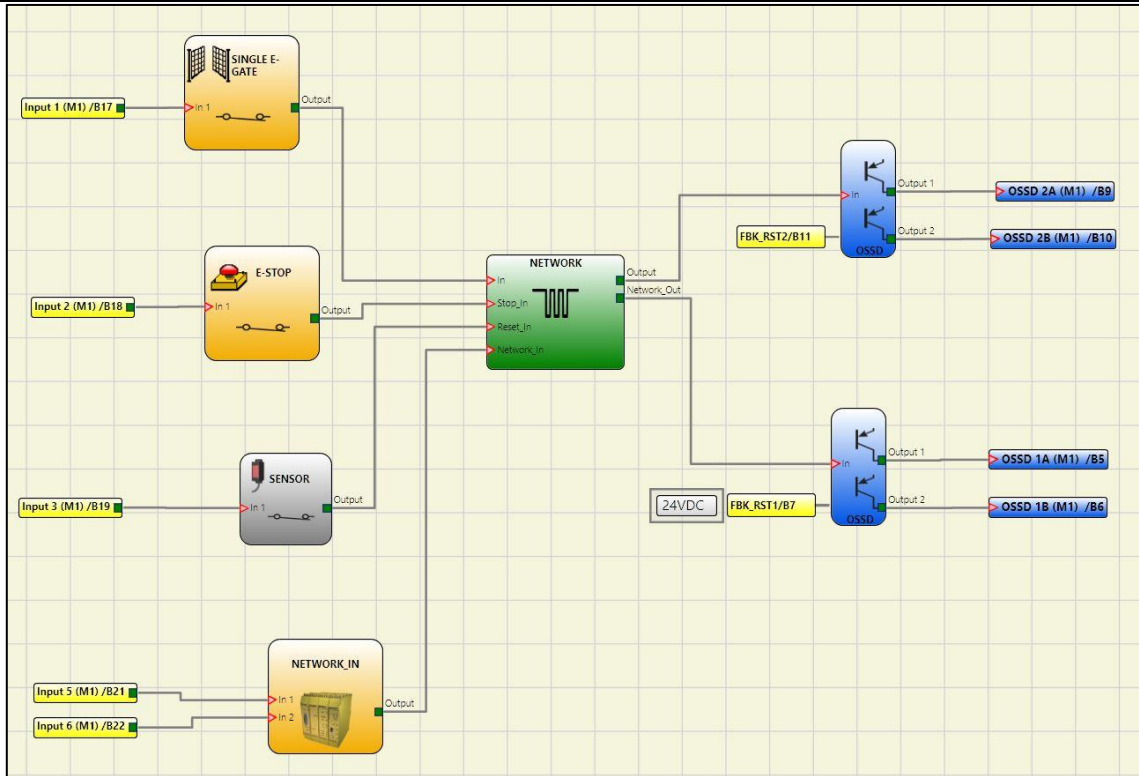
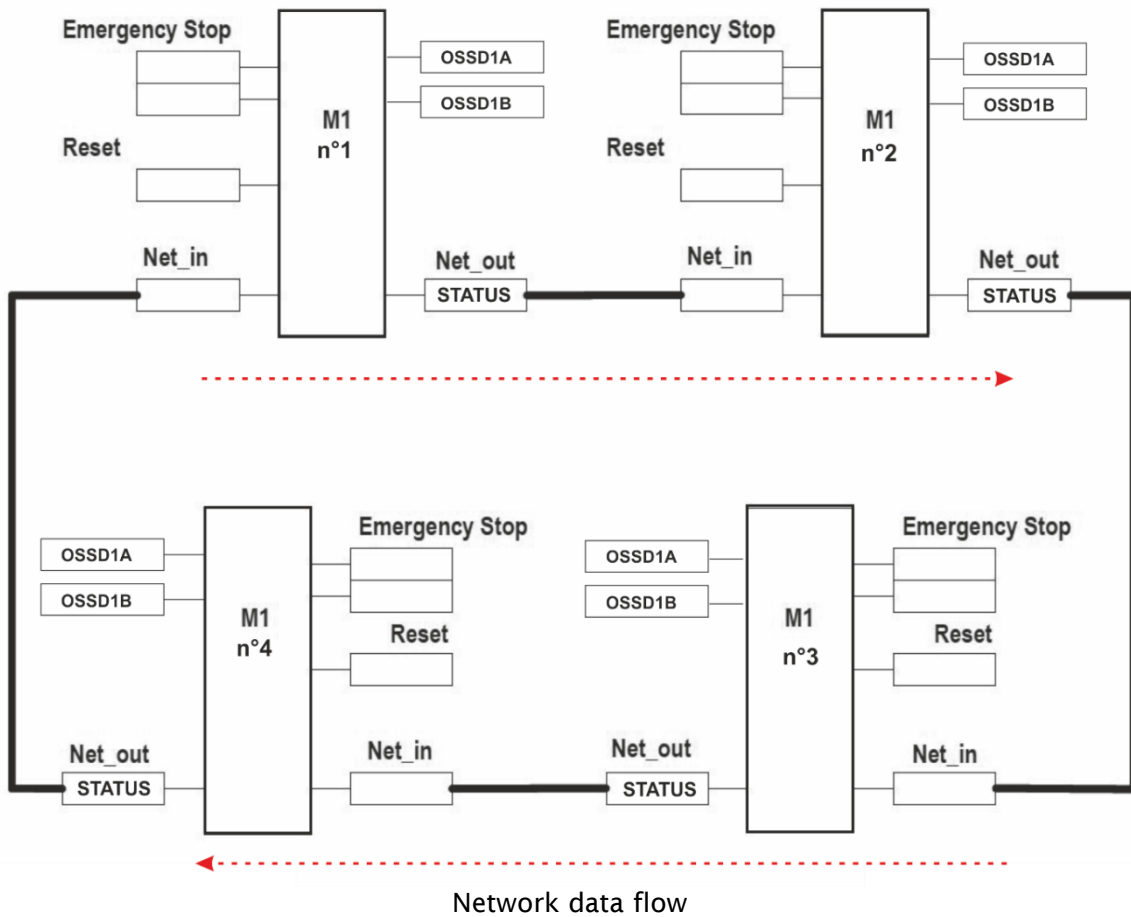

Figure 81 - NETWORK function block scheme example (Category 4)

Example of application in Category 2 according to ISO 13849-1:



Network data flow

Figure 82

**Network parameters for the PL calculation**

Architecture:	Cat.2
Diagnostic coverage:	DC = 90%
Reliability of Module M1:	MTTFd = 437 (years)

Logical block diagram of a safety function using the network

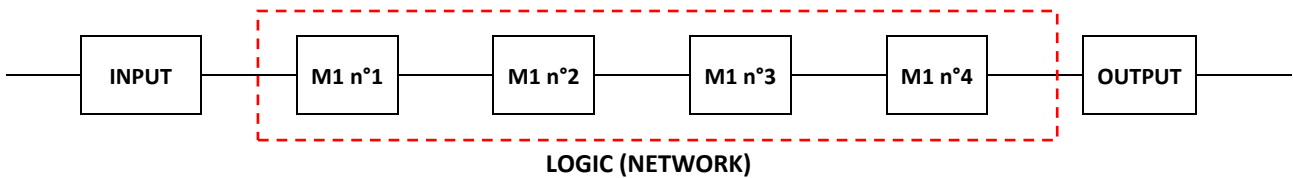

Example of application in Category 4 according to ISO 13849-1:

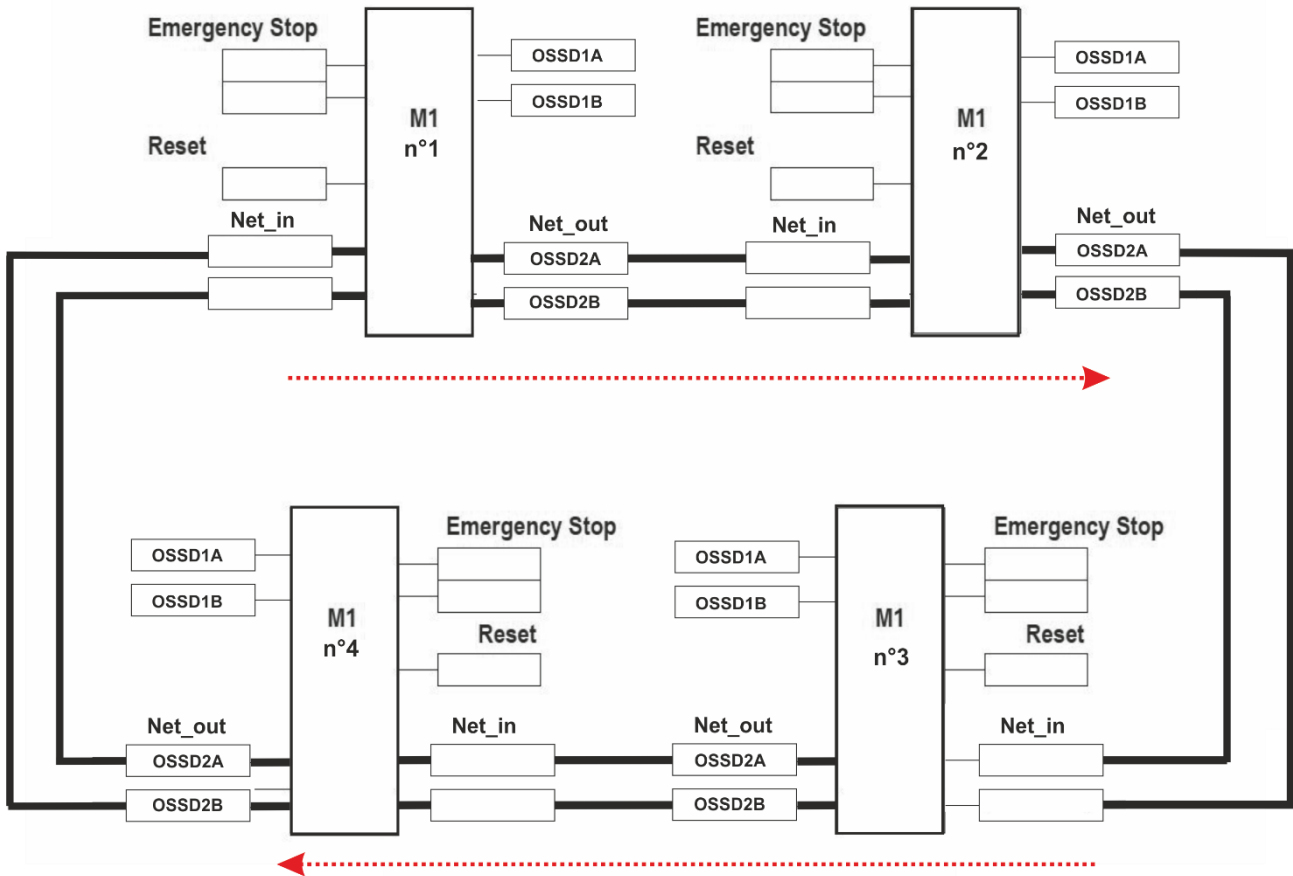

Network data flow

Figure 83

**Network parameters for the PL calculation**

Architecture:	Cat.4
Diagnostic coverage:	DC = 99%
PFH Module M1:	PFHd = 6,86E-09 (hour <sup>-1</sup> )

Logical block diagram of a safety function using the network

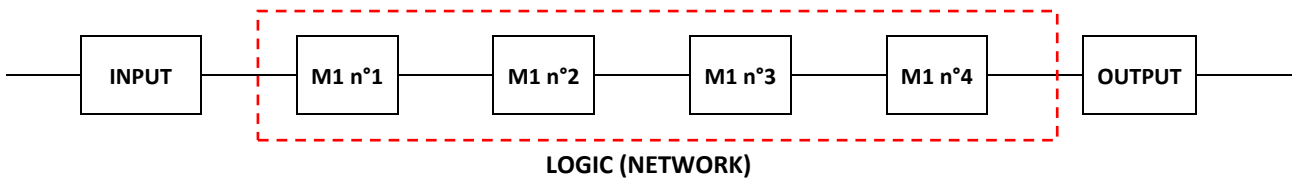

RESET M1

This operator generates a system Reset when there is a double OFF-ON-OFF transition on the corresponding input which lasts less than 5 s.

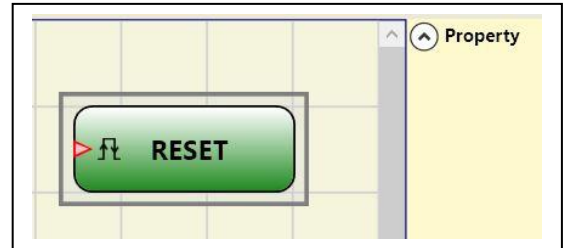
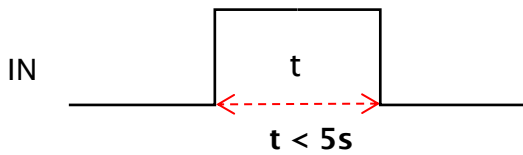

- ➔ If  $t > 5s$ , RESET is not generated.
- ➔ It can be used to reset faults without disconnecting system power.

OSSD EDM (M1S only, max number = 32)

The **OSSD EDM** operator allows to control an EDM feedback related to a safety output using a generic DSC input.

The **Output** can only be connected to one safety output operator (OSSD, single OSSD, Relay).

This output functional block must have the K external time monitor deactivated.

With high level (TRUE) OUTPUT of the connected OSSD, the FBK signal must be at low level (FALSE) and vice versa, within the set time. Otherwise, OUTPUT is set to low level (FALSE) and the error is indicated by the flashing CLEAR LED corresponding to the OSSD in error.

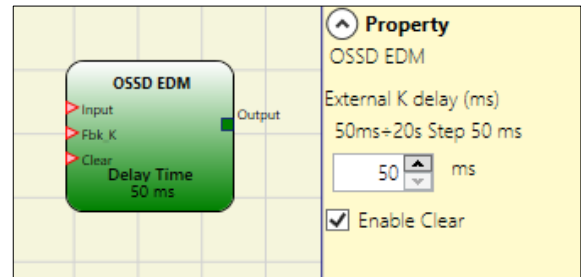

If *Enable Error Out* of the connected output is selected, this output is set to high level (TRUE) when an external FBK error is detected.

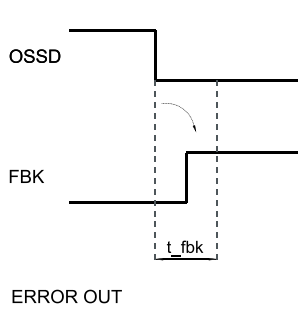

Example of OSSD with correct Fbk signal:  
In this case ERROR OUT=FALSE

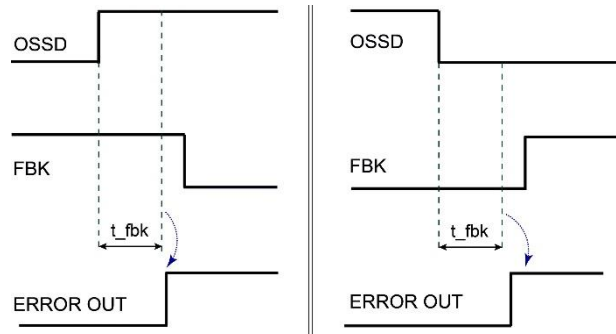

Example of OSSD with incorrect Fbk signal  
(External K delay exceeded):  
In this case ERROR OUT=TRUE

## Parameters

**External K delay:** allows the operator to set the time window within which the external feedback signal (Fbk\_K) is to be monitored (according to output conditions).

**Enable Clear:** if checked enables input Clear.

With this input at 1 it is possible to clear the error when the fault has been repaired. Using this input it is no longer necessary to reset M1S or turn off the system.



Figura 84 - OSSD EDM operator scheme example

## INTERPAGE IN/OUT

If the scheme is very complicated and requires a connection between two elements very far, use the "Interpage" component.

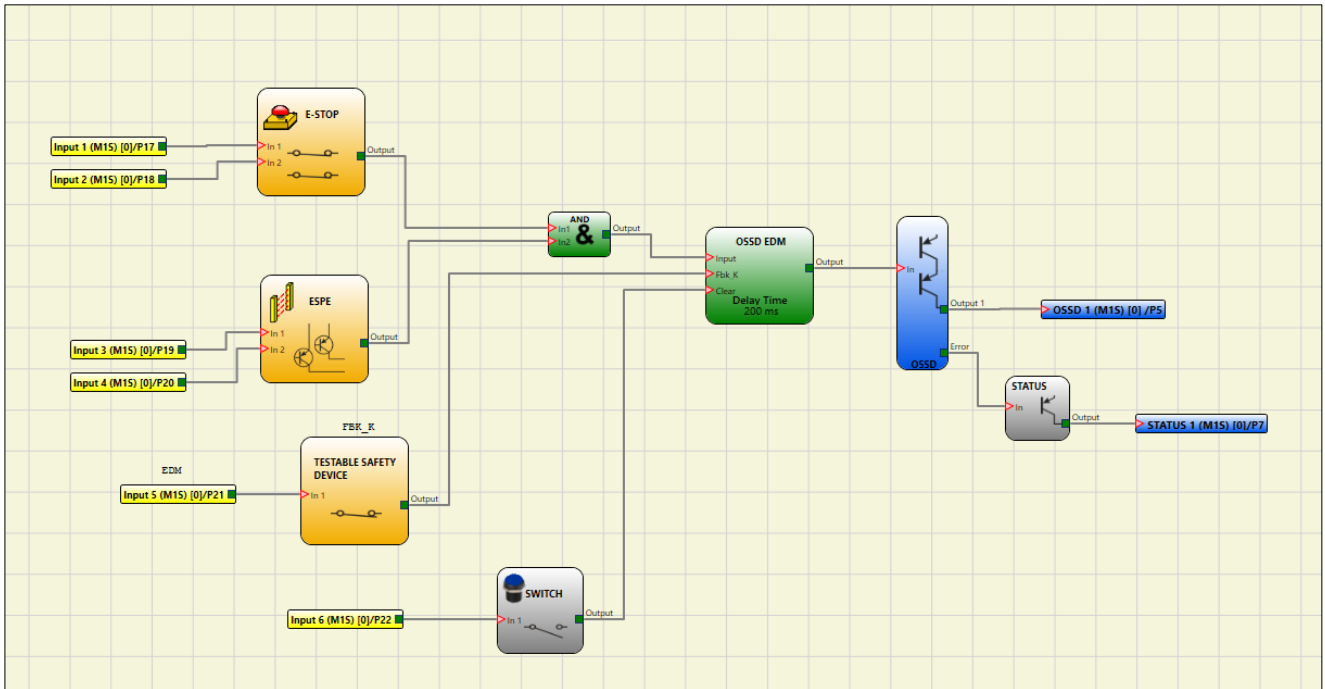
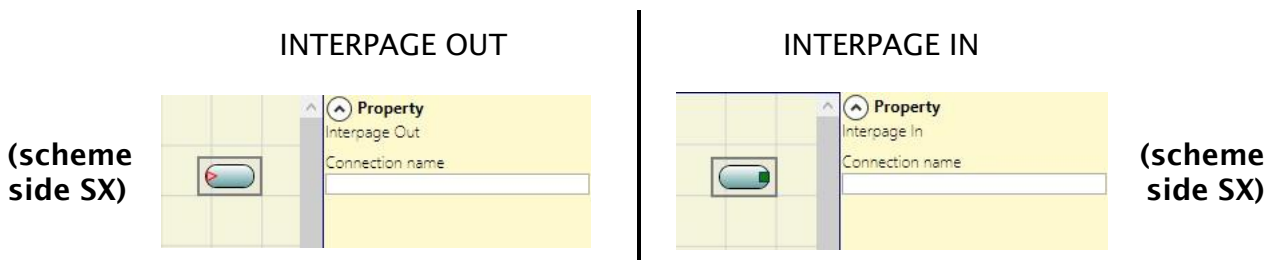

The element "Interpage out" must have a name which, invoked by the corresponding "Interpage in", allows the desired link.

## TERMINATOR

This operator can be used as a terminator for inputs not used in the scheme.

The input connected to the TERMINATOR operator appears in the input map and its status is transferred to the BUS.

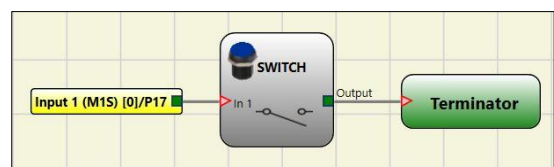

SPECIAL APPLICATIONS

Output delay with manual

If the operator needs to have two OSSD output with one of them delayed (in MANUAL mode) use the following scheme:

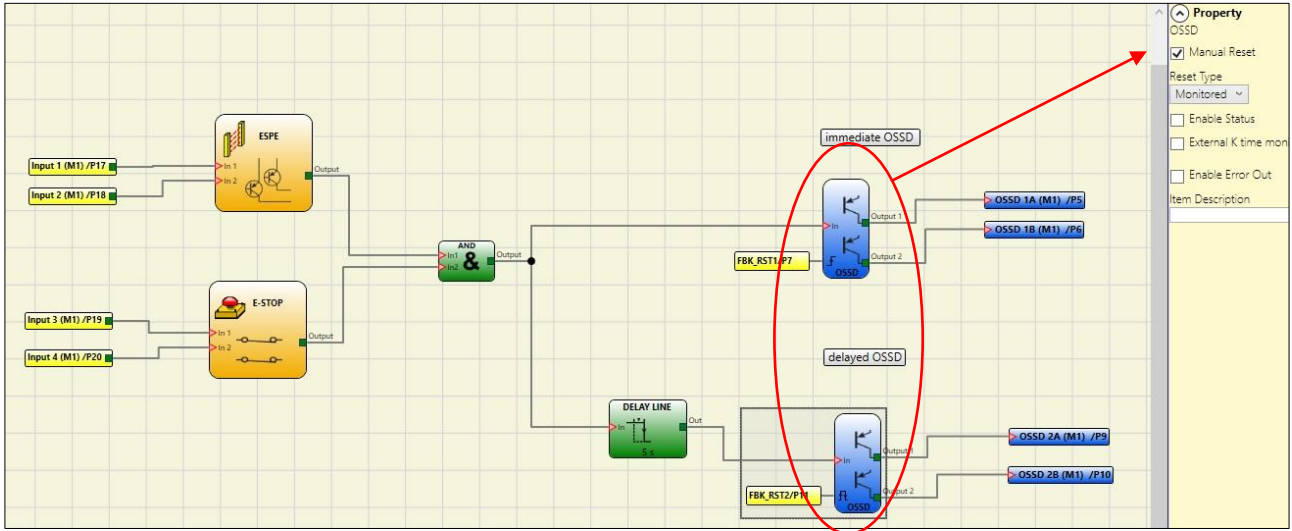

Figure 85 - Two outputs with one delayed (in MANUAL mode)

## SIMULATOR FEATURE

- ✦ This simulator is only designed to assist in the design of safety functions.
- ✦ The results of the simulation do not constitute validation of the project.
- ✦ The resulting safety function must always be validated, from the point of view of both hardware and software, under actual usage conditions in accordance with the applicable regulations, such as ISO/EN 13849-2: validation or IEC/EN 62061: Chapter 8 - Validation of the safety-related electrical control system.
- ✦ DSC configuration safety parameters are provided in the MSD software report.

The top toolbar features two new green icons (with firmware M1 version 3.0 or higher):

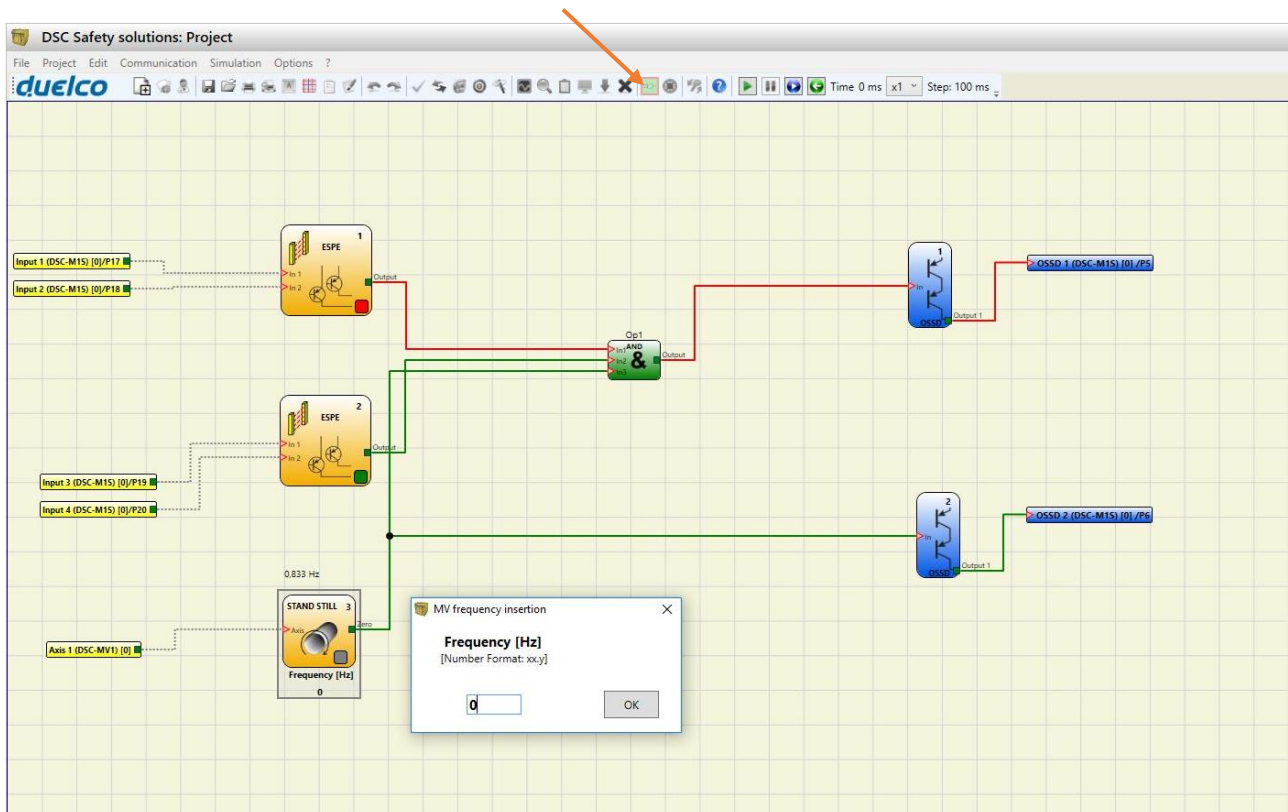





Figure 86 - Simulator icons

These icons refer to the new Simulator function.

- The first icon  indicates "Schematic Simulation". It enables the schematic simulator (both static and dynamic) in which you can activate the input to verify the diagram that is loaded.
- The second icon  indicates "Graphic Simulation". It enables the simulator guided by the stimuli file which also allows the desired traces to be displayed in a specific graph.

➔ THE SIMULATION ICONS ARE ONLY AVAILABLE WITH NODE M1 DISCONNECTED.

## Schematic Simulation

Click on the  icon to start the schematic simulation.

Schematic simulation can be used to check/guide the output signals of the various function blocks in real-time, even during the actual simulation. You may choose the block outputs you wish to control and check the response of the various elements of the schematic model according to the colour of the different lines.

As with the monitor function, the colour of the line (or of the actual key) indicates the signal status: green means the signal is set to LL1, red means the signal is set to LL0.

With "Schematic Simulation", some new keys appear in the toolbar. These can be used to control the simulation: the "Play" and "Stop" keys to start and stop the simulation, the "PlayStep" key for step-by-step operation and the "Reset" key. When the simulation is reset, the Time value is reset to 0 ms.

When you press "Play" to start the simulation, the amount of time that has elapsed is displayed next to the word "Time". This time is measured in "Step" units of time multiplied by the user-defined "KT" factor.

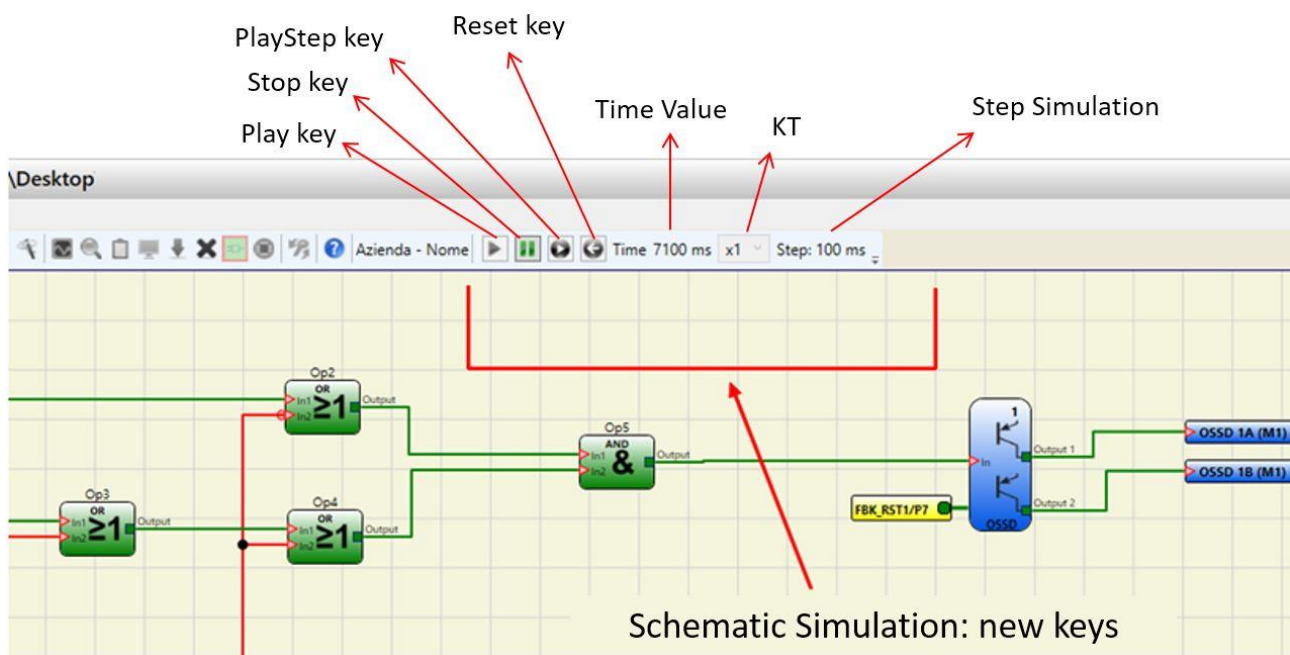

Figure 87 - Schematic Simulation

Click on the bottom right key of each input block to activate the respective output status (even when the simulator is not running, i.e. when the time is not elapsing: in this case the simulation is "static"). If the key turns red when you click on it, the output will be set to level LL0. If it turns green, the output will be set to level LL1.

In some function blocks, such as "speed control" or "lock\_feedback", for example, the key is grey. This indicates that the value must be entered manually in a specific pop-up window. The type of value to be entered differs according to the type of function block (e.g., in a "speed control" block you will need to enter the frequency).



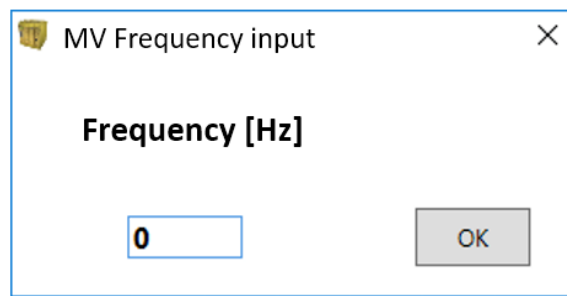
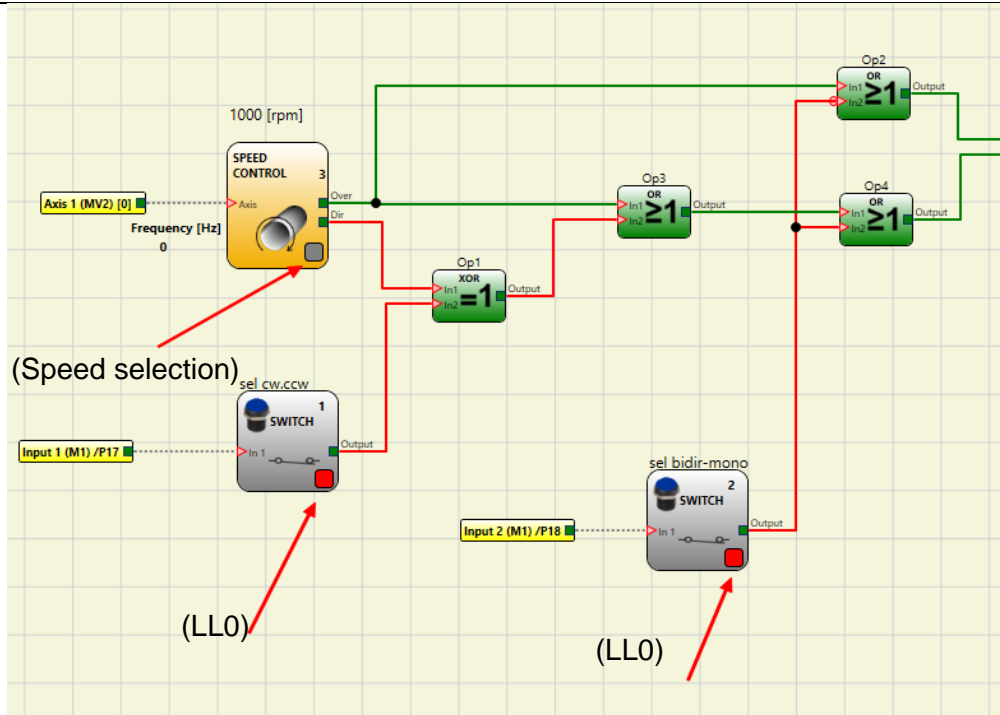

Figure 88 - MV frequency input

➔ The keys for enabling block outputs are shown at the top, an example of a pop-up window for entering, in this case, the frequency in a "speed control" block is shown at the bottom

### How to use graphic simulation

Click on the icon to start the graphic simulation.

Graphic simulation can be used to display the signal pattern over time in a graph. First you must define the stimuli in a specific text file: this means defining the trend over time in the waveforms used as inputs (stimuli). Based on the stimuli file created, the simulator injects these into the diagram and displays the traces required in order to perform the simulation.

When the simulation is complete, a graph like the one shown below is automatically displayed. From the graph you can print the traces displayed ("Print"), save the results in order to load them again later (Save) or display other traces ("Change visibility"). The names of the traces match the description of the function blocks.

Click the "X" key (top right) to exit the graphic simulation environment.

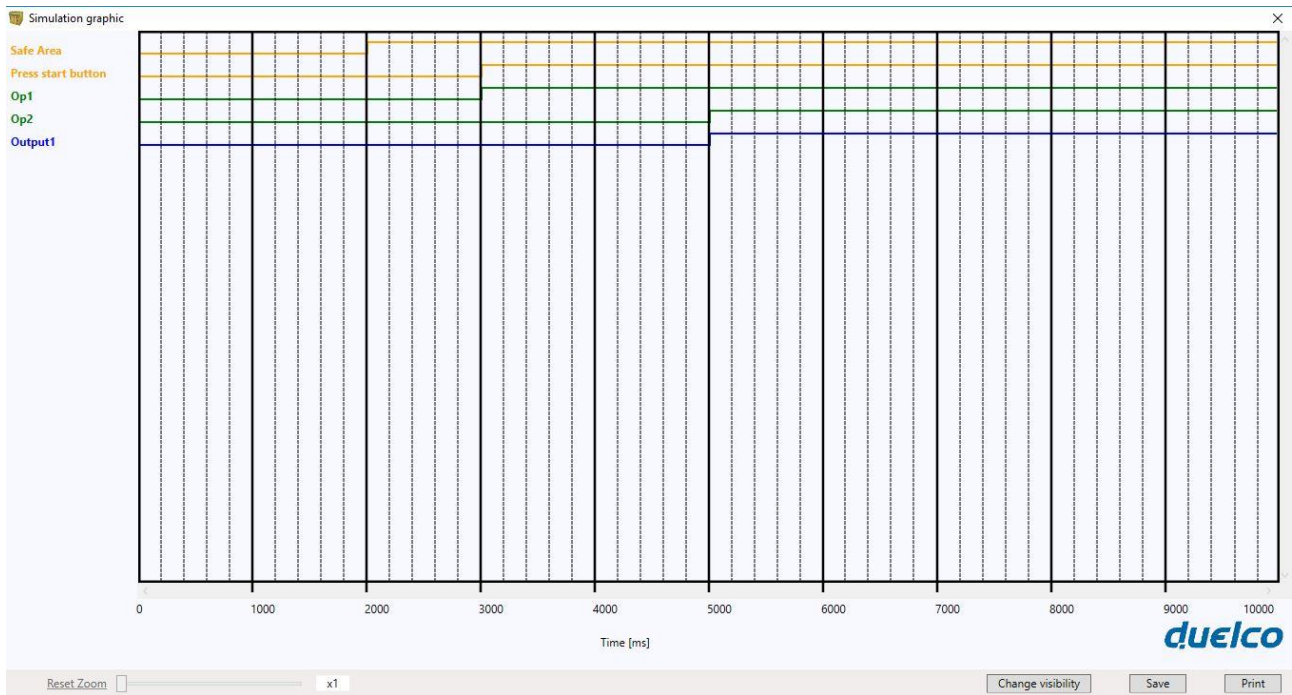

Figure 89 – Example of a result of the graphic simulation.

➔ It shows the traces and the three keys in the bottom right corner for selecting the traces, saving and printing.

The simulation can only be carried out after performing at least the following steps.

1. Create a stimuli file to suit your needs.
2. Upload the stimuli file and wait until the simulation finishes.

Click on the  icon to display the page shown below.

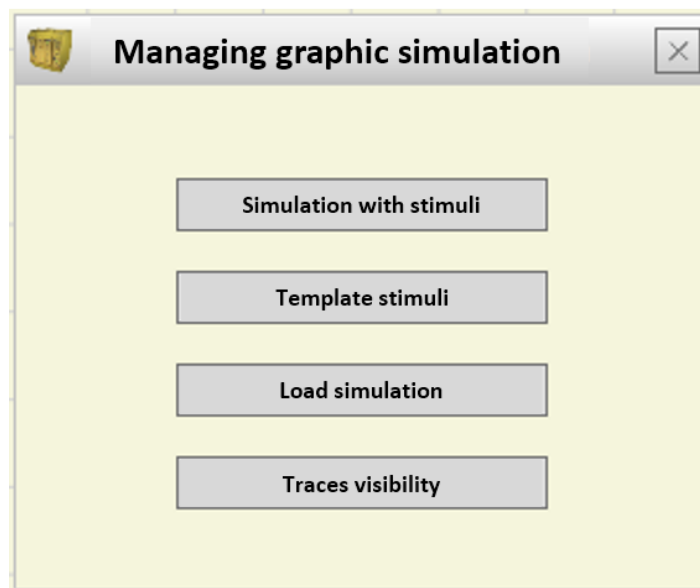

Figure 90 – Menu for selecting the graphic simulation mode

The functions of each key in the menu shown in Figure 90 will now be described:

**Template Stimuli:** used to save the template file with the desired name and disk location. This file will contain the names of the signals as shown in the diagram, Figure 91 Now you may use a text editor to enter the status of the input signals at a given moment in time as well as the duration of the simulation and the time step to be used, Figure 92.

```

// Stimulus Template
//Sim 0:EndTime:Step (time unit ms)
Sim 0:10000:100

// Switch
Input1
0:0
Time1:1
Time2:0

// Switch
Input2
0:0
Time1:1
Time2:0

// Speed Control
SpeedInput3
0:8 Hz
Time1:2500 Hz
Time2:300 Hz

// OSSD
Fbk_rst1
0:0
Time1:1
Time2:0
    
```

Figure 91 - Template file immediately after saving

```

// Stimulus Template

//Sim 0:EndTime:Step (time unit ms)
Sim 0:10000:100

// Switch
Input1
0:0
800:1
2000:0
2500:1
2900:0

// Switch
Input2
0:0
1800:1
2300:0
2900:1
3900:0

// OSSD
Fbk_rst1
0:1
|
    
```

Figure 92 -Example of complete template file

**Simulation with Stimuli:** used to load a template file (suitably completed) and, once loaded, to immediately start the simulation. At the end of the simulation, a graph is displayed with the resulting signals.

**Load simulation:** used to load a previously completed simulation, provided at least one has been saved.

**Traces visibility:** used to select the traces (signal waveforms) to be displayed in the graph. When you press this key, it opens a pop-up window as shown in Figure 93 from which you can add or remove traces to or from the graph.

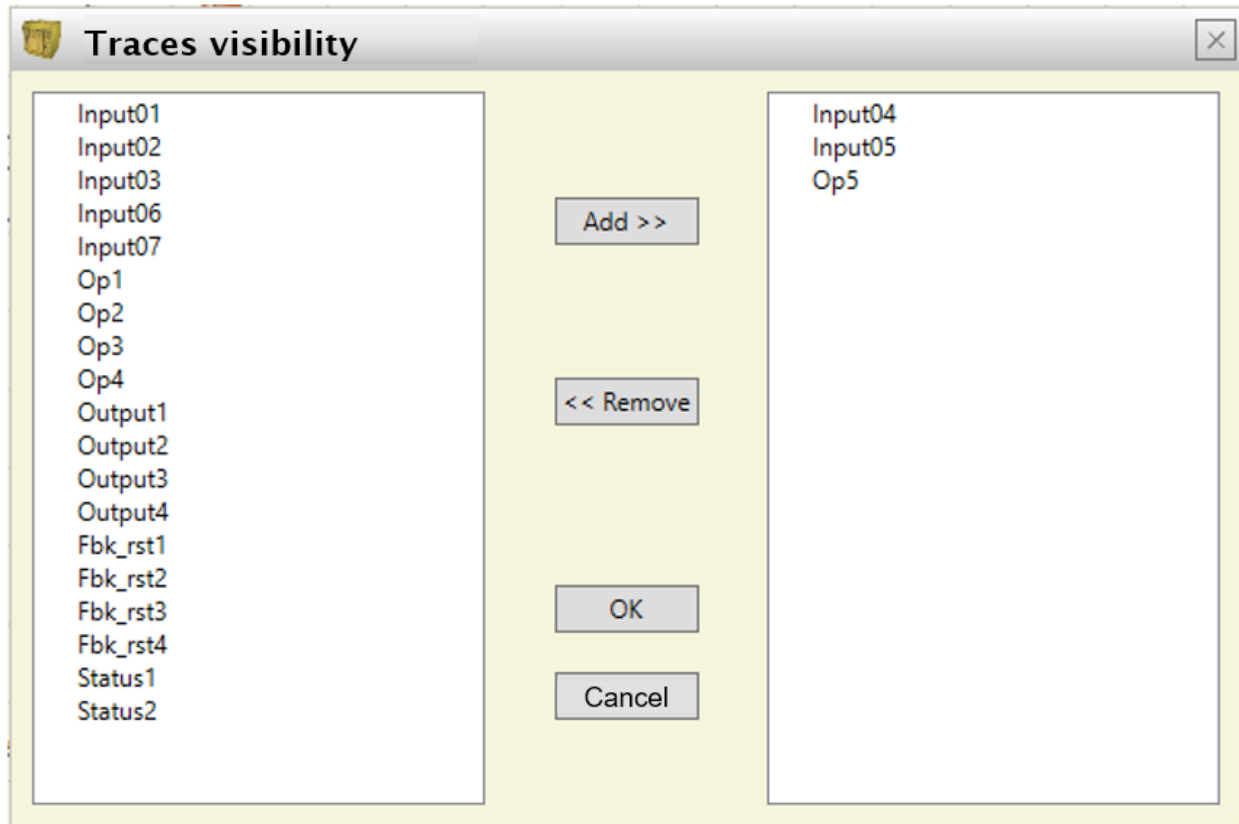

Figure 93 - Traces visibility.

➔ The traces that can be added to the graph are shown in the box on the left. The traces currently displayed and which can be removed from the graph are shown in the box on the right.

Application example of graphic simulation

The following example refers to the use of a press located inside a safety area. The motor of the press can only be started when two conditions are simultaneously true: the safety area gate is closed and the command to start the motor is sent. The motor will start two seconds after the start signal is sent.

**Diagram**

In the diagram the input elements are the safety area gate and the motor start command. These two signals are used as the input for an AND logic operator the result of which will be delayed by two seconds by a retarder block. The delayed signal will then energise the relay which will, in turn, allow the press motor to be started.

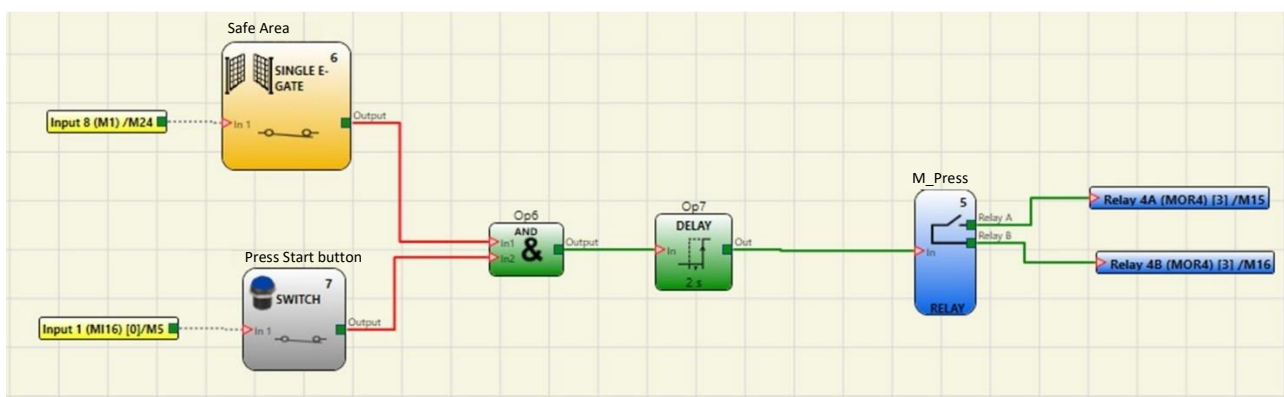

Figure 94 - Diagram referring to the application example

**Stimuli file**

The stimuli file provide the closure of the gate when 2000 ms have elapsed (signal set to LL1) and the start command sent by the operator when 3000 ms have elapsed (signal set to LL1).

```

1 // Stimulus Template
2
3 //Sim 0:EndTime:Step (time unit ms)
4 Sim 0:10000:100
5
6 // Single E-Gate - Safe Area Gate
7 Input6
8 0:0
9 2000:1
10 10000:0
11
12 // Switch Press Start button
13 Input7
14 0:0
15 3000:1
16 10000:0

```

Figure 95 - Stimuli file referring to the application example

## Result of the simulation

The graph shows the signals relating to the simulation, in this case:

- when 2000 ms have elapsed the "Safety area" signal rises to logic level 1, which indicates closing of the gate.
- when 3000 ms have elapsed the "Start\_Press" signal rises to logic level 1, which indicates the request to start sent by the operator
- The AND operator output signal "Op6" rises to logic level 1 when 3000 ms have elapsed, i.e., when the two "Safety area" and "Start\_Press" inputs rise to logic level 1.
- The AND operator output signal is delayed by 2000 ms by the delay operator.
- The "Op7" retarder output signal sends the command to close the relay when 5000 ms have elapsed, at which time the "M-press" relay is activated.

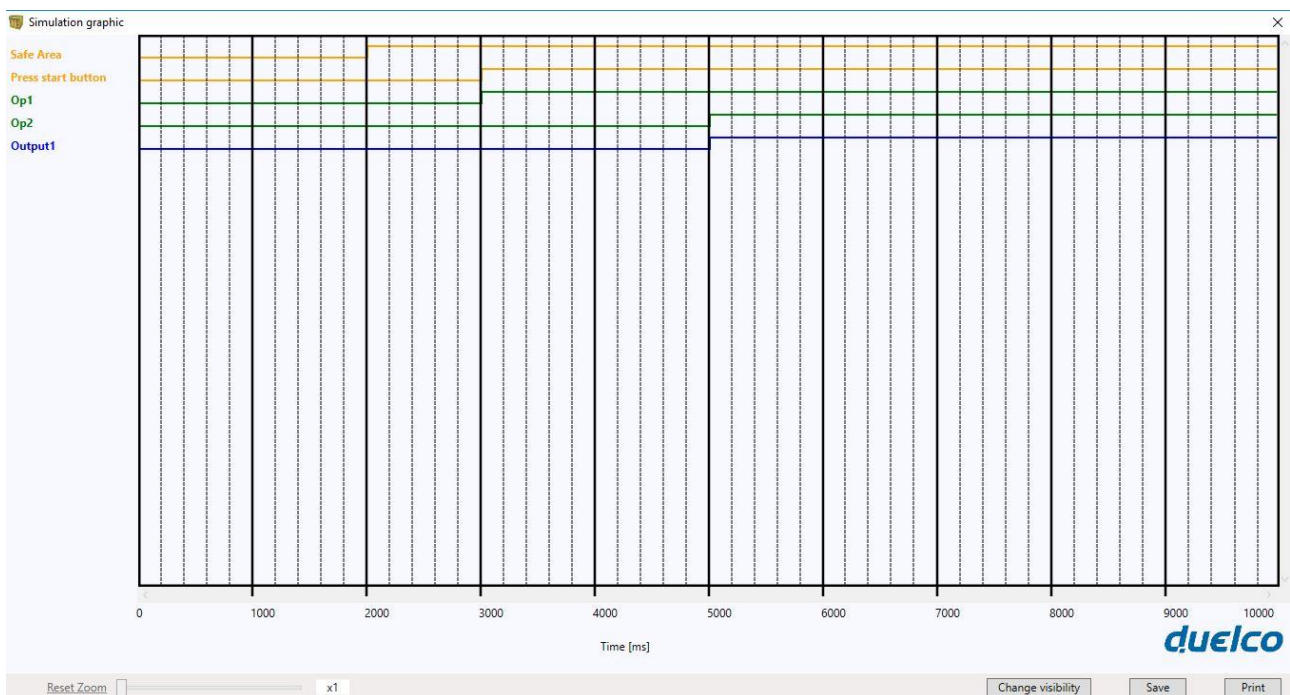



Figure 96 - Graph produced by the simulation of the application example

## DSC FAIL CODES

In case of malfunction the DSC system transmits to the MSD software a code corresponding to the error detected by the master M1/M1S.

To read the code, proceed as follows:

- connect the Master M1/M1S (indicating FAIL by led) to the PC using the USB cable;
- launch the software MSD;
- use the icon  for the connection; a window appears to request the password; enter the password; a window appears with the error code occurred.

The following table lists all possible errors detected and their solution.

CODE	FAIL	RESOLUTION
19D, 20D	<i>The two M1microcontrollers do not see the same hw/sw configuration</i>	CHECK CORRECT INSERTION OF MASTER AND EXPANSION MODULES CONNECTORS DSC-MSC. POSSIBLY REPLACE THE CONNECTORS. IF MCT IS PRESENT, CHECK CONNECTION
66D	<i>2 or more same expansion modules with the same node number</i>	CHECK THE CONNECTIONS PIN 2, 3 EXPANSION MODULES
68D	<i>Exceeded max expansion modules number</i>	DISCONNECT THE MODULES IN EXCESS (MAX14)
70D	<i>One or more modules have detected a change in the node number</i>	CHECK THE CONNECTIONS OF PIN 2, 3 EXPANSION MODULES
73D	<i>A slave module has detected an external error</i>	CHECK THE ERROR CODE ON MODULE FOR MORE INFORMATION
96D ÷ 101D	<i>Errors related to memory DSC-MCM</i>	REPLACE DSC-MCM MEMORY
137D	<i>from a MOR4 MOR4S8 - EDM error on the couple RELAY1 and 2 used in Category 4</i>	CHECK THE CONNECTION OF THE EXTERNAL FEEDBACK CONTACTORS
147D	<i>from MOR4 MOR4S8 - EDM error on the Relay 2 and 3 used in Category 4</i>	CHECK THE CONNECTION OF THE EXTERNAL FEEDBACK CONTACTORS
157D	<i>from a form or MOR4 MOR4S8 - EDM error on the Relay 3 and 4 used in Category 4</i>	CHECK THE CONNECTION OF THE EXTERNAL FEEDBACK CONTACTORS
133D (Proxi1) 140D (Proxi2)	<i>From a module MV2, MV1 or MV0: over-frequency detected on Proximity input</i>	THE INPUT FREQUENCY MUST BE ≤ 5KHz
136D (Encoder1) 143D (Encoder2)	<i>From a module MV2, MV1 or MV0: encoder input signals not Standard (duty cycle, phase displacement)</i>	THE DUTY CYCLE MUST BE: 50% ±33% OF THE PERIOD (HTL, TTL). THE PHASE DISPLACEMENT MUST BE: 90°±45° (HTL, TTL) (not applicable to SIN / COS)
138D (Encoder1) 145D (Encoder2)	<i>From a module MV2, MV1 or MV0: over-frequency detected on Encoder input</i>	THE INPUT FREQUENCY MUST BE: ≤ 500KHz (TTL, SIN/COS); ≤ 300KHz (HTL).
130D 135D 137D 138D 140D 194D 197D 198D 199D 201D 202D 203D 205D	<i>Errors solid state output OSSD1</i>	CHECK THE OSSD1 CONNECTIONS RELATIVE TO THE MODULE IN ERROR
144D 149D 151D 152D 154D 208D 211D 212D 213D 215D 216D 217D 219D	<i>Errors solid state output OSSD2</i>	CHECK THE OSSD2 CONNECTIONS RELATIVE TO THE MODULE IN ERROR
158D 163D 165D 166D 168D 222D 225D 226D 227D 229D 230D 232D 233D	<i>Errors solid state output OSSD3</i>	CHECK THE OSSD3 CONNECTIONS RELATIVE TO THE MODULE IN ERROR
172D 177D 179D 180D 182D 236D 239D 240D 241D 243D 244D 245D 247D	<i>Errors solid state output OSSD3</i>	CHECK THE OSSD3 CONNECTIONS RELATIVE TO THE MODULE IN ERROR
129D	<i>MA4 Measures incongruency</i>	RETURN THE UNIT TO DUELCO
130D, 134D, 142D	<i>MA4 Channel 1 failure</i>	RETURN THE UNIT TO DUELCO
131D, 135D, 143D	<i>MA4 Channel 2 failure</i>	RETURN THE UNIT TO DUELCO
132D, 136D, 144D	<i>MA4 Channel 3 failure</i>	RETURN THE UNIT TO DUELCO
133D, 137D, 145D	<i>MA4 Channel 4 failure</i>	RETURN THE UNIT TO DUELCO
138D	<i>MA4 Channel 1 isolated supply failure</i>	RETURN THE UNIT TO DUELCO
139D	<i>MA4 Channel 2 isolated supply failure</i>	RETURN THE UNIT TO DUELCO
140D	<i>MA4 Channel 3 isolated supply failure</i>	RETURN THE UNIT TO DUELCO
141D	<i>MA4 Channel 4 isolated supply failure</i>	RETURN THE UNIT TO DUELCO
146D	<i>MA4 Connected an M1S not suitable for the application</i>	USE AN M1S WITH THE RIGHT FIRMWARE VERSION (≥5.1)
147D	<i>MA4 Internal failure</i>	RETURN THE UNIT TO DUELCO

**All other codes are related to errors or an internal malfunction. Please replace the module that gave the error or return to Duelco for repair and/or debugging and inform DUELCO at the time of shipment.**

CODE	FAIL	SOLUTION
1D ÷ 31D	Microcontroller Error	TRY TO RESTART SYSTEM. IF ERROR PERSISTS, SEND UNIT TO DUELCO LABORATORY FOR REPAIR.
32D ÷ 63D	Mainboard error	
64D ÷ 95D	Communication error between units	
96D ÷ 127D	DSC-MCM memory card error	REPLACE DSC-MCM MEMORY CARD
128D ÷ 138D	Error module MOR4 relay 1	TRY TO RESTART SYSTEM. IF ERROR PERSISTS, SEND UNIT TO DUELCO LABORATORY FOR REPAIR.
139D ÷ 148D	Error module MOR4 relay 2	
149D ÷ 158D	Error module MOR4 relay 3	
159D ÷ 168D	Error module MOR4 relay 4	
128D ÷ 191D	Error units MV encoder interface	TRY TO RESTART SYSTEM. IF ERROR PERSISTS, SEND UNIT TO DUELCO LABORATORY FOR REPAIR.
128D ÷ 142D	Error module MO4LHCS8 OSSD1	
143D ÷ 156D	Error module MO4LHCS8 OSSD2	
157D ÷ 170D	Error module MO4LHCS8 OSSD3	
171D ÷ 184D	Error module MO4LHCS8 OSSD4	
128D ÷ 143D 192D ÷ 205D	OSSD1 Error	
144D ÷ 159D 206D ÷ 219D	OSSD2 Error	
160D ÷ 173D 220D ÷ 233D	OSSD3 Error	
174D ÷ 188D 234D ÷ 247D	OSSD4 Error	

## ERRORS LOG DOWNLOAD

The errors log file can be visualized using the icon  in the standard tool bar. (Password Required: level 1).

A table will appear with the last 5 errors occurred from the date when the schema was sent to DSC or from the date of error log cancellation (icon .

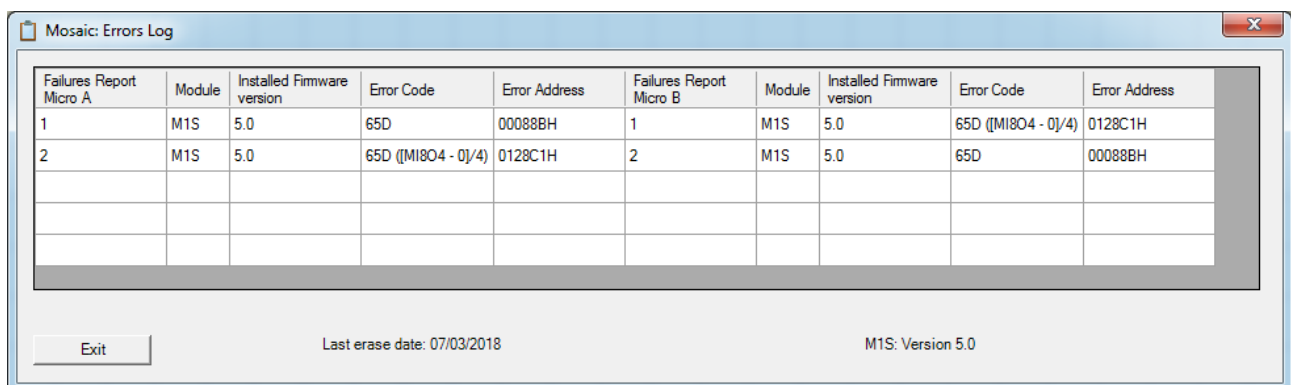

Figure 97 - DSC Errors Log Table



## ACCESSORIES AND SPARE PARTS

MODEL	DESCRIPTION	CODE
DSC-M1	DSC main unit (8 inputs / 2 double OSSD )	1103400
DSC- M1S	DSC main unit (8 inputs / 4 single OSSD )	1103403
DSC-MI8O2	DSC I/O expansion unit (8 inputs / 2 double OSSD)	1103410
DSC-MI8O4	DSC I/O expansion unit (8 inputs / 4 single OSSD)	1103411
DSC-MO4L	DSC output expansion unit (4 single OSSD)	1103412
DSC-MI8	DSC input expansion unit (8 inputs)	1103420
DSC-MI16	DSC input expansion unit (16 inputs)	1103421
DSC-MI12T8	DSC input expansion unit (12 input, 8 test output)	1103422
DSC-MA4	DSC analog input expansion unit (4 channels)	1103425
DSC-MO2	DSC output expansion unit (2 double OSSD)	1103430
DSC-MO4	DSC output expansion unit (4 double OSSD)	1103431
DSC- MO4LHCS8	DSC output expansion unit (4 single OSSD, 8 signal outputs)	1103432
DSC-MR2	DSC safety relay unit (2 relays)	1103440
DSC-MR4	DSC safety relay unit (4 relays)	1103441
DSC-MOR4	DSC safety relay expansion unit (4 relays)	1103442
DSC-MOR4S8	DSC safety relay expansion unit (4 relays, 8 test outputs)	1103443
DSC-MOS8	DSC output expansion unit (8 signal outputs)	1103491
DSC-MOS16	DSC output expansion unit (16 signal outputs)	1103492
DSC-MBP	DSC PROFIBUS DP interface unit	1103450
DSC-MBD	DSC DeviceNet interface unit	1103451
DSC-MBC	DSC CANopen interface unit	1103452
DSC-MBEC	DSC ETHERCAT interface unit	1103453
DSC-MBEI	DSC ETHERNET/IP interface unit	1103454
DSC-MBEP	DSC PROFINET interface unit	1103455
DSC-MBMR	DSC MODBUS RTU interface unit	1103482
DSC-MBEM	DSC MODBUS TCP interface unit	1103483
DSC-MBEI2B	DSC ETHERNET/IP interface unit 2 PORT interface unit	1103485
DSC-MCT2	DSC BUS TRANSFER interface unit (2 channels)	1103458
DSC-MCT1	DSC BUS TRANSFER interface unit (1 channel)	1103457
DSC-MBCCL	DSC MBCCL CC-Link interface unit	1103459
DSC-MCM	DSC external configuration memory	1103460
DSC-MSC	DSC connector for 5-way communication	1103461
DSC-CSU	DSC USB cable for connection to PC	1103462
DSC-MV1T	DSC TTL expansion unit	1103470
DSC-MV1TB	DSC TTL expansion unit	1103486
DSC-MV1H	DSC HTL expansion unit	1103471
DSC-MV1S	DSC SIN/COS expansion unit	1103472
DSC-MV2T	DSC TTL expansion unit (2 encoders)	1103473
DSC-MV2TB	DSC TTL alim.int.exp.unit	1103487
DSC-MV2H	DSC HTL expansion unit (2 encoders)	1103474
DSC-MV2S	DSC SIN/COS expansion Unit (2 encoders)	1103476
DSC-MV0	DSC proximity expansion unit	1103477

---

## WARRANTY

---

Duelco warrants that all of its DSC units shall be free from defects in material or workmanship for a period of 12 (twelve) months from the date of shipment. This warranty applies to the products under normal conditions of use.

If the product proves to be defective during the warranty period, Duelco will repair or replace any faulty parts without any charge for material or labour.

Duelco S.p.A. may, at its discretion, replace the defective equipment with the same type of equipment or with equipment having the same characteristics, rather than repair it.

This warranty is subject to the conditions listed below:

The customer must inform Duelco of the fault within twelve months from the date of delivery of the product.

The equipment and all components must be in the condition as they were at the time of delivery by Duelco.

The fault or defect must not be caused either directly or indirectly by:

- Improper use;
- Failure to comply with the instructions for use;
- Carelessness, misuse, incorrect maintenance;
- Repairs, modifications, adaptations not performed by Duelco, tampering, etc.;
- Accidents or collisions (also during transportation and as a result of force majeure);
- Other causes for which Duelco cannot be held liable.

The defective equipment must be delivered or shipped to Duelco's works to be repaired: the warranty does not cover costs of transport or the risk of damage to or loss of the equipment during shipment, which shall be borne by the customer.

All products and components that are replaced become the property of Duelco.

Duelco shall not be held liable under any other warranties or rights except for those expressly indicated above. Duelco shall not therefore accept claims to pay damages for expenses, interruption of work or other factors or circumstances in any way related to failure of the product or any parts thereof.

 Precise, complete compliance with all standards, instructions and warnings in this handbook is essential for the correct operation of the device. Duelco therefore declines any responsibility for all and anything resulting from failure to comply with all or some of the aforesaid instructions.

*Characteristics are subject to change without prior notice. No part of this document may be reproduced unless authorised by Duelco.*



Duelco A/S  
Systemvej 8  
DK-9200 Aalborg SV  
Tel. +45 70101007  
Fax +45 70101008  
[www.duelco-safety.com](http://www.duelco-safety.com)  
[safety@duelco.dk](mailto:safety@duelco.dk)