

Flexible connectors • Solderless terminals • Contact-systems

# druseidt

Elektrotechnik



Catalogue 1

Professional installation- and electrical connection technique for craft, industry and high current application



© 2018, 1. edition 2018

Paul Druseidt  
Elektrotechnische Spezialfabrik GmbH & Co. KG  
Neuenkamper Str. 105  
42855 Remscheid, Germany

Phone: +49 (21 91) 93 52-0  
Telefax: +49 (21 91) 93 52-150  
http: [www.druseidt.de](http://www.druseidt.de)  
E-Mail: [info@druseidt.de](mailto:info@druseidt.de)

The measurements and technical information written in this catalogue have been determined with greatest care and are updated continuously in our documentation. The illustrations correspond to the status at the time of printing. We reserve us the right to make technical as well as changes of measurements, colours or formats after printing.

**Our information, especially the values of possible current-loads are not binding, they are only approximate values under optimized conditions. The relation between conductor cross-section and current load fixed in national or international regulations are not cancelled through our information.**

Only the values in our written confirmations are binding for us.

The use of photos, drawings or other parts of this catalogue for own advertisement or other usage is subject to our formerly written acceptance.



# druseidt

Elektrotechnik

**Professional installation- and electrical connection technique for craft, industry and high current application**



## About us – a brief company profile

The company druseidt is one of the old-established Remscheid companies and was founded before 1890. Caused by the various kinds of developments and patents in the field of switch-board and installation engineering the company was already well known before the beginning of the 2nd world war. Well known products in the past were the different druseidt control panel clamps and fuse elements.

Today the Paul Druseidt GmbH & Co. KG is an internationally operating middle class company. A wide range of some thousands standardized articles as well as a multiplicity number of customized products, mainly in the field of high current application, offers an interesting program of modern components for energy distribution as well as installation application.

**Decades of experience and technical know how combined with modern manufacturing technology are the basis for worldwide and successful activities.**

More than 100 years of experience guarantee our quality and technical know how

Advertisement in the year of 1901



Factory view Karl-Kahlhöfer-Straße

Today key aspects and fields of our activities are particularly:

- Solderless cable connection material, installation material including the necessary processing technology (crimping-, cutting- and stripping tools)
- Manufacturing, developing and designing of air- and water cooled high current cables as well as flexible connectors consisting out of ropes, braids and strips
- Contact systems and current supplies for anodizing and electroplating plants
- Designing and manufacturing of plant components, current supplies and energy distribution components mainly in the field of high current transmission



Major building Neuenkamper Straße



Main entrance



## Electrical connection technique

High quality cable lugs and connectors handled with professional and ergonomic designed druseidt tools guarantee professional electrical connections conforming to the norms and regulations.

The product range cable lugs is complemented by an extensive range of electrical installation material, so that it is possible to buy a great number of products by only one supplier.

A wide assortment from stock-run cable lugs and connectors are the basis for fast and reliable deliveries.



## Best quality and best customizing services

We are working in the field of high current transmission. Therefore application also for some thousands amps are no problem for us.

Especially we take a look at top-quality and offer correspondent testing facilities.

We are certified acc. to ISO 9001:2008 and have an extensive QM-system.

We design our products with 3-D-systems and offer extensive manufacturing processes for customized solutions.

We are flexible and offer more than just the simply delivery of electrical installation material e.g.

- realization of a high quality standard
- quick delivery of products
- extensive support and consultation in matters of system installation of cable lugs, tools and manufacturing devices
- realization of logistic conceptions in cooperation with our customers
- inspection and repairing of tools





## Exact testing

**Comprehensive testing capabilities are the basis and the condition for delivering a high quality-standard.**

Accuratness, quality and flexibility combined with high advisory skills are essential principles of our company policy. So we think that it is the right way to realize a long-term business relationship and customer satisfaction. Please test our ability. We would be glad to discuss with your company too.



Testing of the conductivity



Material testing



Generating grinding surface pattern



Analysis of grinding surface pattern

## We deliver suitable cable lugs and connectors nearly for all possible kinds of application

### Why are different cable lug series needed?

In consequence of the various kinds of leadings and cables with different conductor constructions, different strandings and diameters also different sizes of cable lugs and connectors are required too. Unprofessional done crimping operations or wrong selected cable lugs are often the reason for generating fires, damaging of plants, unnecessary system down times and unnecessary repairing works.

To guarantee crimping operations according to the norms and regulations it is absolutely necessary that cable lug, crimping tool and the outside-Ø of the stripped cable are aligned to each other. Therefore it is very important to select the right cable lugs.



#### Important

Leading, cable lug, tool and compression die must be aligned to each other!

### Which is the correct cable lug for the various applications?

An important question for the user is now what is the correct cable lug for his application and what is the right tool for crimping it? At first we have to take a view to the application.

There must be questions like dimension of the mounting situation, temperature and environmental influences clarified. Is it necessary to work with another material like copper etc.? After the operation conditions are clear you have generally to pay attention to the fact that the cross-section of the cable and the cable lug must be the same. It is not allowed to work with a cable lug with a smaller cross-section than the cable (only a crimping of cable lugs with a bigger cross-section than the cable is allowed).

To get a sufficient filling volume the inside-Ø of the cable lug sleeve and the outside-Ø of the stripped cable should be nearly the same. Because the outside-Ø of the stripped cables are not normed and the conductor cross-section will be calculated according to the conductor resistance and not according to the geometrical values (cf. DIN VDE 0295/IEC 60228) the suitable cable lug must be selected acc. to the actual diameter of the stripped cable.



#### Important

It is absolutely necessary that cable and cable lug have minimum the same cross-section and the outside diameter of the stripped cable and the inside diameter of the cable lug sleeve must be nearly the same!



## What kind of cable lugs are standard in the druseidt company?

In Germany some engineering standards for cable lugs are defined, but caused by the various kinds of different cable-constructions no further norms were identified. Therefore the cable lug manufacturers offer additionally to the normed ones different series manufactured in trade design.

So our company offers an extensive range of cable lugs both standardized and commercially.

Description	Material	Design	Cross-section	Catalogue page
<b>Normed designs</b>				
Insulated cable lugs DIN 46237	Copper	Punched out of sheet, connection sleeve soldered	up to 6 mm <sup>2</sup>	14
Insulated cable lugs DIN 46231	Copper	Punched out of sheet, connection sleeve soldered	up to 6 mm <sup>2</sup>	15
Uninsulated cable lugs DIN 46234	Copper	Punched out of sheet, connection sleeve soldered	up to 240 mm <sup>2</sup>	24/25
Uninsulated cable lugs DIN 46230	Copper	Punched out of sheet, connection sleeve soldered	up to 16 mm <sup>2</sup>	28
Uninsulated cable lugs DIN 46211	Brass	Punched out of sheet, connection sleeve open	up to 95 mm <sup>2</sup>	27
Uninsulated cable lugs DIN 46225 design A	Brass	Punched out of sheet, connection sleeve open	up to 6 mm <sup>2</sup>	82
Uninsulated cable lugs DIN 46235	Copper	Punched out of tube	up to 1000 mm <sup>2</sup>	49 ff
Uninsulated cable lugs DIN 46239	Aluminium	Punched out of solid material	up to 500 mm <sup>2</sup>	55 ff
<b>Usual in trade designs</b>				
Insulated cable lugs inside-Ø of the sleeves similar to DIN 46237	Copper	Punched out of sheet, connection sleeve soldered	up to 150 mm <sup>2</sup>	14 ff
Uninsulated cable lugs inside-Ø of the sleeves similar to DIN 46211	Copper	Punched out of sheet, connection sleeve soldered	up to 300 mm <sup>2</sup>	26
Uninsulated pin connectors	Copper	Punched out of sheet, connection sleeve soldered	up to 95 mm <sup>2</sup>	28
Uninsulated tubular cable lugs druseidt standard design	Copper	Punched out of tube	up to 630 mm <sup>2</sup>	29 ff
Uninsulated tubular cable lugs druseidt Euro-design	Copper	Punched out of tube	up to 630 mm <sup>2</sup>	41 ff
Uninsulated tubular cable lugs for fine stranded cables	Copper	Punched out of tube	up to 300 mm <sup>2</sup>	35 ff
Uninsulated flag-type cable lugs	Copper	Punched out of tube	up to 150 mm <sup>2</sup>	28
Uninsulated hook-type cable lugs	Copper	Punched out of solid material	up to 150 mm <sup>2</sup>	51
Bimetallic cable lugs	Aluminium/Copper	Punched out of solid material and welded	up to 300 mm <sup>2</sup>	58
Nickel cable lugs	Nickel	Punched out of tube	up to 16 mm <sup>2</sup>	62
Stainless steel cable lugs	Stainless Steel A4	Punched out of tube	up to 95 mm <sup>2</sup>	63
Punched screwable cable lugs	Copper	Punched out of sheet	up to 240 mm <sup>2</sup>	64

	Catalogue page
<b>1. ELECTRICAL CONNECTION- AND INSTALLATION TECHNOLOGY</b>	
<b>1.1 Insulated cable lugs and connectors</b>	
Insulated cable lugs ring-type up to 6 mm <sup>2</sup>	14
Insulated cable lugs fork- and pin-type	15
Insulated cable lugs > 6 mm <sup>2</sup> and insulated end-connectors	16
Insulated butt- and parallel connectors	17
Insulated receptacles	18-19
Insulated male/female bullets	20
Insulated shrinkable cable lugs and connectors	20-21
Insulated solder splices and assortment-boxes	22
<b>1.2 Uninsulated cable lugs and connectors</b>	
Uninsulated cable lugs ring- and fork-type DIN 46234 and special designs	24-25
Uninsulated cable lugs usual in trade designs and connectors acc. to DIN 46341 part 1 design A	26
Uninsulated connectors acc. to DIN 46341 part 1 design B and cable lugs acc. to DIN 46211 design A	27
Uninsulated pin- and flag-type cable lugs	28
<b>1.3 Uninsulated tubular cable lugs and connectors druseidt standard design</b>	
Ring-type design	30-31
Angle-type design	32-33
Fork-type design and butt connectors	34
<b>1.4 Uninsulated tubular cable lugs and connectors for fine stranded cables</b>	
Ring-type design	36
Angle-type design	37
Ring-type design with smaller flange and butt connectors	38
Angle-type design with smaller flange and crimping examples	39
Silicone insulated leadings	40
<b>1.5 Uninsulated tubular cable lugs and connectors druseidt Euro-design</b>	
Ring-type design	42-43
Ring-type design with smaller flange	44
Angle-type design	45-47
Butt- and T-shaped connectors	48
<b>1.6. Uninsulated tubular cable lugs DIN-types as well as reduction sleeves and H-shaped connectors out of copper</b>	
Ring-type acc. to DIN 46235 and special designs	50-51
Angle-types	52
Connectors acc. to DIN 46267 part 1 and H-shaped connectors	53
Reduction sleeves and cable lugs in special design	54
<b>1.7. Uninsulated cable lugs and connectors made out of aluminium resp. bimetallic designs</b>	
AL-Ring-type acc. to DIN 46329	56
AL-connectors acc. to DIN 46267 part 2 as well as connectors with oil stop	57
Bimetallic cable lugs	58
Bimetallic connectors	59
Bimetallic sheets, washers and seal contact-modules	60
<b>1.8 Special cable lugs and connectors</b>	
Cable lugs and connectors made out of nickel	62
Cable lugs made out of stainless steel A4	63
Punched, screwable cable lugs made out of copper	64
<b>1.9 Cable end sleeves</b>	
Uninsulated acc. to DIN 46228 part 1 and special design	66-67
Insulated acc. to DIN 46228 part 4 and special design	68-69
Insulated twin cable end sleeves and insulated cable end sleeves with big insulation sleeve	70
Assortment boxes	71-74
<b>1.10 Uninsulated crimping contacts as well as insulating sleeves and flat terminals</b>	
Uninsulated crimping contacts 2,8 mm	76
Uninsulated crimping contacts 4,8 mm	77
Uninsulated crimping contacts 6,3 mm	78-82
Uninsulated cable lugs acc. to DIN 46225 design A	82
Insulating sleeves for tabs and receptacles	83
Plug in- and flat terminals	84-86
<b>1.11 Conductor connecting terminals, earth and neutral bars and insulators</b>	
Screwable connectors	88
Universal and brace terminals	89
Earth and neutral bars	90-91
Insulators	92-94



	Catalogue page
<b>1.12 High current plugs and sockets</b>	
Plugs and sockets with thread connection	96
Plugs and sockets with crimp connection	97
Ready assembled cables with plug connectors and sockets	98
<b>1.13 Battery clamps or clips and earthing tapes</b>	
Battery clips and jump loads	100-101
Battery clamps and clips	102-103
Earthing tapes	104
<b>1.14 Connectors and accessories for test bay and switch board application</b>	
Highly flexible connecting leads with plugs 4 mm Ø	106
Multilam-, clip-on and connecting plugs 4 mm Ø	107-108
Insulated and uninsulated sockets 4 mm Ø	109-110
Adapters 4 mm Ø	110
Insulated and uninsulated crocodile clips with connection sleeve 4 mm Ø	111
Flat test clips and test probes with connection sleeve 4 mm Ø	112
Test plugs, adapters and couplings	113
Binding posts 16-400 A	114-117
Lead through bolts 16-400 A	118-119
Cable ties and accessories	120
<b>1.15 Neoprene sleeves, insulation- and shrinkable tubing as well as copper paste and cleaning sprays</b>	
Neoprene sleeves and accessories	122
Heat shrinkable tubing material (thin wall design)	123-125
Heat shrinkable tubing material (middle wall design)	125
Heat shrinkable tubing material (double wall design)	126
PVC-insulating tubing	126-127
Silicone insulating tubing	127
Protection-, maintenance and cleaning sprays	128
Copper paste	128
<b>2. CUTTING-, STRIPPING- AND CRIMPING TOOLS</b>	
<b>2.1. Cutting tools</b>	
Cutting tools for copper and aluminium cables	132
Cutting tools with ratchet and jointed arm	133
Cutting tools with ratchet	134-136
Pneumatically actuated cutting device	137
Battery operated cutting tools	138-139
Hydraulic operated cutting heads	140/195
<b>2.2 Stripping tools</b>	
Stripping tools for PVC-leads	142
Stripping tools with exchangeable stripping cassettes	142-143
Cable stripping knife	144
Stripping tools for solar cables	144
Stripping device with exchangeable blades	145
Pneumatically operated stripping machine	146
<b>2.3 Crimping tools for cable end sleeves</b>	
Hand operated tools	148-150
Quadro-tool	150
<b>2.4 Hand operated, multifunction-tools as well as machines for crimping insulated and uninsulated cable lugs and connectors</b>	
Crimping tools for insulated connectors	152
Multifunction crimping tools	153-154
Crimping tools for Coax-connectors	154
Crimping tools for uninsulated tabs and receptacles	154-155
Battery operated electro mechanical crimping machine	156-157
Electrical operated crimping machine	158
Pneumatically operated crimping machine	159
Crimping tools for uninsulated cable lugs and connectors	160-162
<b>2.5 Power-supported crimping tools</b>	
Crimping tools with ratchet	164-170
Hydraulic operated crimping tools	161-173
Battery operated crimping and cutting tools	174-192
Electro hydraulic pumps with exchangeable compression- and cutting heads	193-201
druseidt system crimping dies size I-III	202-209
<b>3. TECHNICAL APPENDIX/NUMERICAL INDEX</b>	
	210-220

## Listing of the DIN-articles

Norm	Description	Catalogue page
DIN 46211	design A Ring-type solder tags	27
DIN 46225	design A Ring-type crimp terminals	82
DIN 46228	page 1 Uninsulated cable end sleeves	66-67
DIN 46228	page 4 Insulated cable end sleeves	69
DIN 46230	Uninsulated pin connectors	28
DIN 46231	Insulated pin connectors	15
DIN 46234	Uninsulated cable lugs	24-25
DIN 46235	Uninsulated tubular cable lugs	50
DIN 46237	Insulated cable lugs	14
DIN 46244	part 1 Different connectors with dimensions in the tab sector acc. to DIN 46244 part 1	79-80
DIN 46245	part 1 Uninsulated receptacles 2,8 mm	18
DIN 46245	part 2 Uninsulated receptacles 4,8 mm	18
DIN 46245	part 3 Uninsulated receptacles 6,3 mm	18
DIN 46247	part 1 Uninsulated receptacles 2,8 mmt	76
DIN 46247	part 2 Uninsulated receptacles 4,8 mm	77
DIN 46248	part 3/A Uninsulated receptacles 6,3 mm	80
DIN 46267	part 1 Copper compression lugs	53
DIN 46267	part 2 Aluminium compression lugs	57
DIN 46329	Aluminium-cable lugs, longitudinally sealed	56
DIN 46330	part 2/A Uninsulated receptacles 2,8 mm	76
DIN 46340	part 1/A + B Uninsulated receptacles 2,8 mm	76
DIN 46340	part 3/A + B Uninsulated receptacles 6,3 mm	78
DIN 46341	design A Uninsulated parallel connectors	27
DIN 46341	design B Uninsulated butt connectors	28
DIN 46342	part 1/design A + B Uninsulated flat connectors	81
DIN 46345	part 1 Uninsulated tabs 6,3 mm	79
DIN 46346	design A + B Uninsulated multiple tabs 6,3 mm	78
DIN 72331	Screwable battery clamps	102
DIN 72332	Soldering battery clamps	102
DIN 72333	part 3/design A + B Earthing tapes	104



# 1. ELECTRICAL CONNECTION- AND INSTALLATION TECHNIQUE

## 1.1 Insulated cable lugs and connectors

The druseidt company delivers various kinds of insulated cable lugs and connectors acc. to DIN 46237, 46231, 46245 part 1-3 as well as usual in trade designs up to a cross-section range of 150 mm<sup>2</sup>. The used insulating materials are PA heat resistant up to + 105° C, PC heat resistant up to + 100° C, PVC heat resistant up to + 70° C.

All cable lugs are manufactured out of copper with a high conductivity and will be hard soldered in the range of the connecting sleeve. The inner parts of the connecting sleeves are chamfered and raise the cohesion of the crimping. The easy entry insulation sleeves are free of halogen and enable an easy insertion of conductors. To protect cable connections against moisture, shrinkable designs with adhesive are offered too. The recommend crimping design is a so called oval crimping acc. to the adjoining examples.

Please notice, that the crimping operations will be done only with the right and suitable tools and die-sets.

Recommend crimping:  
Oval-crimping

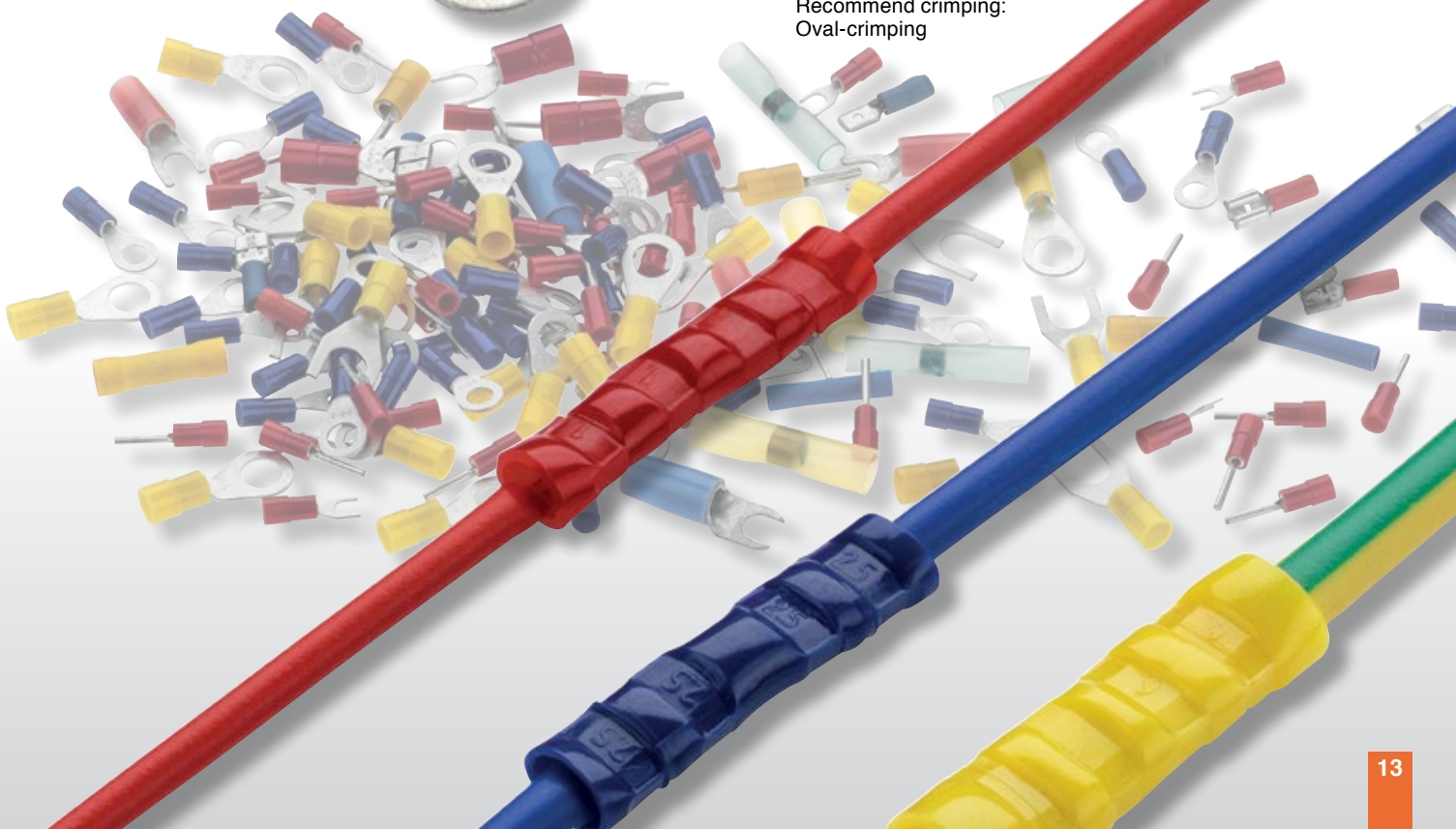

### Insulated cable lugs 0,5-6 mm<sup>2</sup>

Ringtype in acc. with DIN 46237  
with flared insulation sleeve  
Material: Cu-HTP, tinned and soldered  
Insulation sleeve: PA, free of halogen

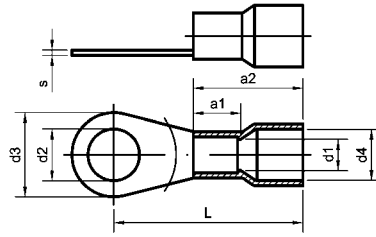
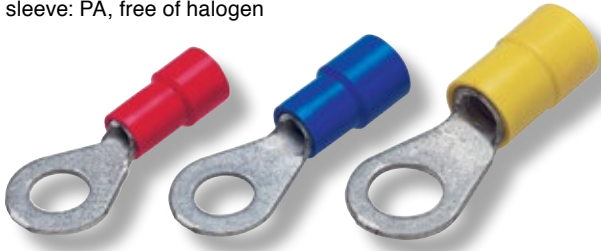

Part-No.	cross-section mm <sup>2</sup>	drilling M	dimensions mm									weight kg/ ‰ pcs.	crimping-tools/page no.	
			d <sub>1</sub>	d <sub>2</sub>	d <sub>3</sub>	d <sub>4</sub>	L	a <sub>1</sub>	a <sub>2</sub>	s				
01006.01.02	0,5-1	2,5	1,6	2,7	6	4,1	16,5	5,5	11	0,80	0,60	12430, 12408 page no. 158; 12425 page no. 159, 12230 page no. 156	12858, 05160/61/62 page no. 153	12600/N, 12601, 05180 page no. 152
01007.01.02		3		3,2	6		17				0,60			
01008.01.02		3,5			3,7	6		17			0,55			
01010.01.02		4			4,3	8		18			0,70			
01012.01.02		5			5,3	10		19			0,90			
01013.01.02		6			6,4	11		21			0,80			
01015.01.02	8			8,4	11,6		21,6			1,30				
01016.01.02	1,5-2,5	3	2,3	3,2	6	4,5	17	5,5	11	0,80	0,65			
01017.01.02		3,5		3,7	6		17				0,65			
01020.01.02		4		4,3	8		18				0,80			
01022.01.02		5		5,3	10		20				0,90			
01024.01.02		6		6,4	11		22				1,10			
01025.01.02		8		8,4	14		23				1,30			
01026.01.02	10		10,5	14		25				1,60				
01028.01.02	4-6	4	3,6	4,3	8	6,5	21	6,0	13	1,00	1,40			
01029.01.02		5		5,3	10		22				1,60			
01030.01.02		6		6,4	11		23				1,70			
01031.01.02		8		8,4	14		26				2,20			
01032.01.02		10		10,5	18		28				2,90			

### Insulated cable lugs, 0,1-6 mm<sup>2</sup>

Ringtype, in special design  
not in acc. with DIN Material: Cu-HTP,  
tinned and soldered  
Insulation sleeve: PVC or PA

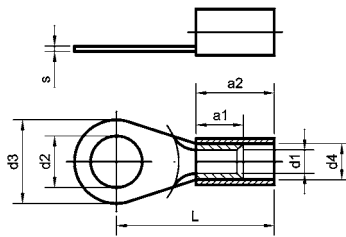

Part-No.		cross-section mm <sup>2</sup>	drilling M	dimensions mm									weight kg / ‰ pcs.	crimping-tools/page no.
PVC	PA			d <sub>1</sub>	d <sub>2</sub>	d <sub>3</sub>	d <sub>4</sub>	L	a <sub>1</sub>	a <sub>2</sub>	s			
-	01000.01	0,1-0,5	2	1	2,2	5	2	14	4	8	0,5	0,23	05103 page no. 152 05160/05162 page no. 153	
-	01001.01		3		3,2	5		14				0,20		
-	01002.01		4		4,3	7		16				0,26		
-	01003.01		5		5,3	8		15				0,28		
01005	01005.01	0,5-1	2	1,6	2,2	6	3,2	16	5	10	0,8	0,55	12430, 12408 page no. 158 12425 page no. 159, 12230 page no. 156	12600/N, 12601, 05180 page no. 152
01009	01009.01		4		4,3	7		16				0,70		
01011	01011.01		5		5,3	8		17				0,90		
01014	01014.01		6		6,5	12		22				1,30		
01018	01018.01	1,5-2,5	3,5	2,3	3,7	6,8	4,3	17	5	11	0,8	0,65		
01019	01019.01		4		4,3	6,8		17				0,80		
01021	01021.01		5		5,3	8		18				0,90		
01023	01023.01		6		6,5	10		20				1,10		
01027	01027.01		12		13,0	18		26				1,50		
01033	01033.01		4-6	12	3,6	13,0	18	6,4	27	6	12	1		



## Insulated cable lugs 0,1-16 mm<sup>2</sup>

Forktype with flared insulation sleeve  
Material: Cu-HCP, tinned and soldered  
Insulation sleeve: PA, free of halogen

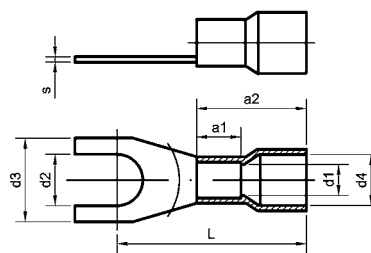
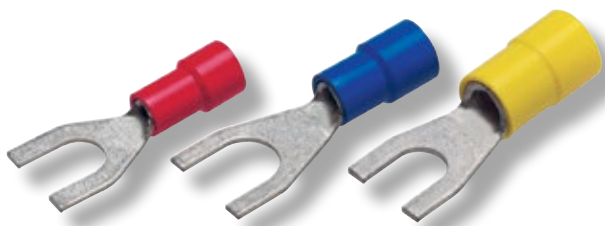

Part-No.	cross-section mm <sup>2</sup>	drilling M	dimensions mm								weight kg/% pcs.	crimping-tools/page no.
			d <sub>1</sub>	d <sub>2</sub>	d <sub>3</sub>	d <sub>4</sub>	L	a <sub>1</sub>	a <sub>2</sub>	s		
01040.01*	0,1-0,5	3	1	3,2	5	2	14	4	8	0,5	0,20	05103, 05160
01041.01.02	0,5-1	3	1,6	3,2	6	4,1	17	5	10,5	0,8	0,60	12430, 12408 page no. 158 12425 page no. 159, 12230 page no. 156
01042.01.02		3,5		3,7	6,4		17				0,60	
01044.01.02		4		4,3	6,4		17				0,70	
01045.01.02		5		5,3	10		19				0,90	
01046.01.02		6		6,4	11		21				0,80	
01048.01.02	1,5-2,5	3	2,3	3,2	6	4,5	17	5	11,5	0,8	0,60	
01050.01.02		3,5		3,7	6		17				0,65	
01051.01.02		4		4,3	6,4		17,3				0,80	
01053.01.02		5		5,3	10		20				0,90	
01054.01.02		6		6,4	11		22				1,10	
01055.01.02	4-6	4	3,6	4,3	8	6,5	21	6	12,5	1	1,40	12600/N, 12601, 05180 page no. 152 12655 page no. 165 30460 page no. 167 31460 page no. 169 12930/33 page no. 171
01056.01.02		5		5,3	10		22				1,60	
01057.01.02		6		6,4	11		23				1,70	
01058.01.02		8		8,4	14		26				2,20	
01059.01.02		10		10,5	18		28				2,80	
10021.01.02	10	5	4,5	5,3	10,5	8	23,8	8	16	1	2,30	
01060.01.02		6		6,5	11		24,4				2,40	
01062.01.02	16	6	5,8	6,5	11	10,9	32,1	10	20	1	3,80	
01063.01.02		8		8,4	14		34,1				5,00	

\* Design without flared insulation sleeve

## Insulated Pin connectors 0,1-35 mm<sup>2</sup>

DIN 46231 and special design  
with and without flared insulation sleeve  
Material: Cu-HCP, tinned and soldered  
Insulation sleeve: PVC or PA free of halogen

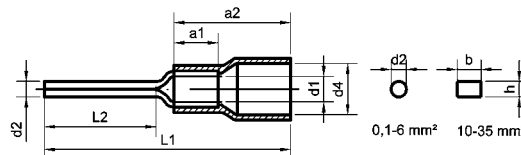

PVC	Part-No.	cross-section mm <sup>2</sup>	DIN-type	dimensions mm										weight kg/% Stck	crimping-tools/page no.
				d <sub>1</sub>	d <sub>2</sub>	b	h	d <sub>4</sub>	a <sub>1</sub>	a <sub>2</sub>	L <sub>1</sub>	L <sub>2</sub>			
-	01070.01	0,1 - 0,5	-	1	1,4	-	-	2	4	8	18	8	0,30	05103, 05160	
-	01071.01.02*	0,5-1	1	1,6	1,9	-	-	4,1	5	11	22,5	10	0,70	12600/N, 12601, 05180 page no. 152	
01072	01072.01		-			-	-	3,2		10,5	20	8	0,65	12858, 05160/61/62 page no. 153	
01073	01073.01		-			-	-	3,2			17	5	0,60	12430, 12408 page no. 158	
-	01074.01.02*	1,5-2,5	2,5	2,3	1,9	-	-	4,5	5,5	11	23,5	10	0,75	12425 page no. 159, 12230 page no. 156	
01076	01076.01		-			-	-	5,1	5	11,5	28	15	0,90	12602 page no. 152	
-	01077.01.02*	4-6	6	3,6	2,7	-	-	6,5	6	12,5	26,5	11	1,70	12655 page no. 165	
-	01078.01.02*	10	-	4,5	-	4,3	2,4	7,7	8	20	34	12	2,55	30460 page no. 167	
-	01079.01.02*	16	-	5,8	-	5,6	2,5	9	10	24,2	40,7	13,5	4,30	31460 page no. 169	
-	01092.01.02*	25	-	7	-	6,9	2,5	12,4	13,5	24,8	44	16	6,85	12930/33 page no. 171	
-	01094.01.02*	35	-	8,4	-	8,1	3,2	14	16	27,8	52,5	20	12,20		

\* Design with flared insulation sleeve

**Insulated cable lugs 10-150 mm<sup>2</sup>**

Ringtype, with flared insulation sleeve

Material: Cu-ETP, tinned and soldered

Insulation sleeve: PA, free of halogen

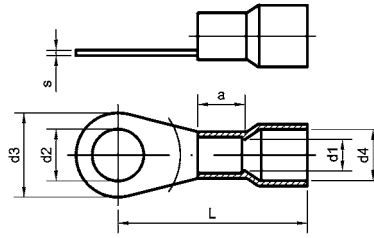

Part-No.	cross-section mm <sup>2</sup>	drilling M	dimensions mm							weight kg/% pcs.	crimping-tools/page no.				
			d <sub>1</sub>	d <sub>2</sub>	d <sub>3</sub>	d <sub>4</sub>	L	a	s		12230 page no. 156	12602 page no. 152	12655 page no. 165	30460 page no. 167; 12930/33 page no.171	31460 page no. 169
01461.01.02	10	5	4,5	5,3	10	8	24,5	8	1,1	2,30					
01462.01.02		6		6,5	11		25,5			2,45					
01463.01.02		8		8,4	14		28,5			2,95					
01464.01.02		10		10,5	18		29,5			3,50					
01466.01.02	16	5	5,8	5,3	11	10,5	31,5	10	1,2	4,00					
01467.01.02		6		6,5	11		31,5			3,80					
01468.01.02		8		8,4	14		33,5			4,25					
01469.01.02		10		10,5	18		35,5			5,00					
01471.01.02	25	5	7,5	5,3	12	13	38	11	1,5	7,00					
01472.01.02		6		6,5	12		38			7,00					
01473.01.02		8		8,4	16		38			7,60					
01474.01.02		10		10,5	18		39			7,80					
01475.01.02		12		13	22		44			9,70					
01476.01.02	35	6	9	6,5	15	14,5	41	12	1,6	9,70					
01477.01.02		8		8,4	16		41			9,70					
01478.01.02		10		10,5	18		42			10,00					
01479.01.02		12		13	22		46			11,70					
01494.01.02	50	6	11	6,5	18	16,5	47,5	16	1,8	17,55					
01480.01.02		8		8,4	18		47,5			17,10					
01481.01.02		10		10,5	18		47,5			16,50					
01482.01.02		12		13	22		49,5			18,00					
01483.01.02	70	6	13	6,5	22	18,7	51	18	2	26,30					
01484.01.02		8		8,4	22		51			26,30					
01485.01.02		10		10,5	22		51			25,50					
01486.01.02		12		13	22		51			24,70					
01487.01.02		16		17	28		55			27,70					
01495.01.02	95	8	15	8,4	24	21,7	57,5	20	2,5	41,10					
01488.01.02		10		10,5	24		57,5			41,70					
01489.01.02		12		13	24		57,5			39,40					
01490.01.02		16		17	28		59,5			39,40					
01496.01.02	120	8	16,5	8,4	24	24,2	62	22	3	57,70					
01491.01.02		10		10,5	24		62			56,70					
01492.01.02		12		13	24		62			53,30					
01493.01.02		16		17	28		66			64,10					
01497.01.02	150	10	19	10,5	30	27,2	70	24	3,2	82,90					
01498.01.02		12		13	30		70			78,30					
01499.01.02		16		17	30		70			80,10					

**Insulated closed end terminals 1,5-6 mm<sup>2</sup>**

Material: Cu-ETP, tinned

Insulation sleeve: PA, free of halogen

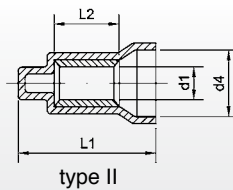
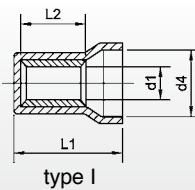
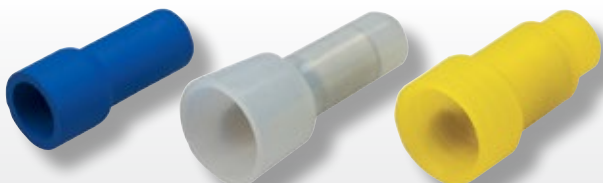

Best-Nr.	cross-section mm <sup>2</sup>	type	dimensions mm				weight kg/% pcs.	crimping-tools/page no.
			d <sub>1</sub>	d <sub>4</sub>	L <sub>1</sub>	L <sub>2</sub>		
01088.01	1,5-2,5	I	3,0	8,0	21	7	0,60	12600/N, 12601, 05180 page no. 152
01090.01	1,5-2,5		2,3	5,2	16	7	0,50	12858/05160/61/62 page no. 153
01091.01	4-6		3,6	9,0	18	7	1,42	12430, 12408, 12425 page no. 158/59
01089.01	4-6	II	3,8	9,5	27	7	0,90	12230 page no. 156



**Insulated butt connectors 0,1-6 mm<sup>2</sup>**

Material: Cu-ETP tinned

Insulation sleeve: PVC or PA, free of halogen

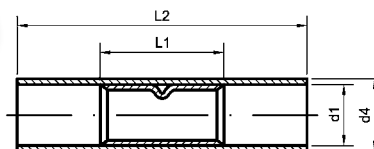
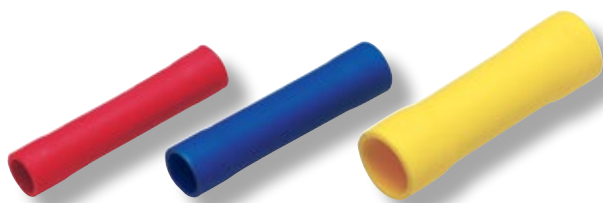

Part-No.		cross-section mm <sup>2</sup>	dimensions mm				weight kg/% pcs.	crimping-tools/page no.
PVC	PA		d <sub>1</sub>	d <sub>4</sub>	L <sub>1</sub>	L <sub>2</sub>		
-	10022.01	0,1-0,5	1,2	2	12	20	0,30	05103, 05160 S. 152/153
01080	01080.01	0,5-1,0	1,6	3,2	15	25	0,90	12600/N, 12601, 05180 page no. 152
01081	01081.01	1,5-2,5	2,3	4	15	25	1,15	12858/05160/61/62 page no. 153
01082	01082.01	4-6	3,6	5,8	15	27	2,50	12430, 12408, 12425 page no. 158/59

**Insulated butt connectors 0,5-6 mm<sup>2</sup>**

with flared insulation sleeve

Material: Cu-ETP tinned

Insulation sleeve: PC, free of halogen

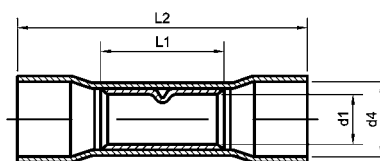
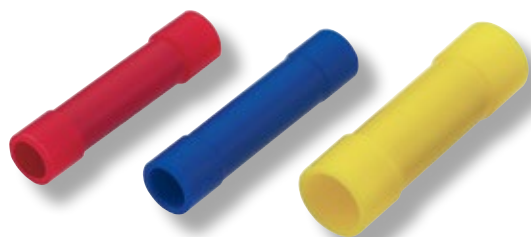

Part-No.	cross-section mm <sup>2</sup>	d <sub>1</sub>	dimensions mm		weight kg/% pcs.	crimping-tools/page no.	
			d <sub>4</sub>	L <sub>1</sub>	L <sub>2</sub>		
01080.02	0,5-1,0	1,6	4,1	15	25	1,10	12600/N, 12601, 05180 page no. 152
01081.02	1,5-2,5	2,3	4,5	15	26	1,20	12858/05160/61/62 page no. 153
01082.02	4-6	3,6	6,4	15	27	2,60	12430, 12408, 12425 page no. 158/59

**Insulated parallel-connectors 0,1-6 mm<sup>2</sup>**

Material: Cu-ETP, tinned

Insulation sleeve: PVC or PA, free of halogen

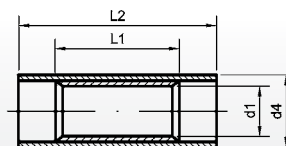
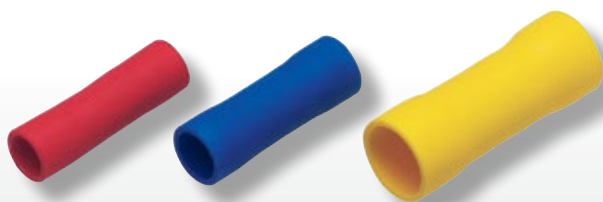

Part-No.		cross-section mm <sup>2</sup>	dimensions mm				weight kg/% pcs.	crimping-tools/page no.
PVC	PA		d <sub>1</sub>	d <sub>4</sub>	L <sub>1</sub>	L <sub>2</sub>		
-	10024.01	0,1-0,5	1,2	2,0	5	13	0,15	05103, 05160 S. 152/153
01083	01083.01	0,5-1,0	1,6	3,2	7	17	0,40	12600/N, 12601, 05180 page no. 152
01084	01084.01	1,5-2,5	2,3	4,6	7	17	0,50	12858/05160/61/62 page no. 153
01085	01085.01	4-6	3,6	6,4	7	21	0,90	12430, 12408, 12425 page no. 158/59

**Insulated receptacles 0,5-6 mm<sup>2</sup>**

in acc. with DIN 46245 part 1-3 and special design

with add. metallic insulation enclosure

Material: brass, tinned

Insulation sleeve: PVC

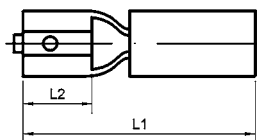

Part-No.	cross-section mm <sup>2</sup>	tab-width mm	tab-thickness mm	DIN-size	dimensions mm		weight kg/‰ pcs.	crimping-tools/page no.
					L <sub>1</sub>	L <sub>2</sub>		
01100	0,5-1,0	2,8	0,5	A 2,8 - 1	17,5	8	0,33	12600/N, 12601, 05180 page no. 152 12858, 05160/61/62 page no. 153 12430, 12408 page no. 158 12425 page no. 159 12230 page no. 156
01101			0,8	B 2,8 - 1			0,33	
01102	0,5-1,0	4,8	0,5	-	18	6	0,50	
01103	1,5-2,5			-			0,48	
01104	0,5-1,0	4,8	0,8	4,8 - 1			0,50	
01105	1,5-2,5			4,8 - 2,5			0,48	
01106	0,5-1,0	6,3	0,8	6,3 - 1	22	7,4	0,82	
01107	1,5-2,5			6,3 - 2,5			0,92	
01108	4-6			6,3 - 6			0,98	
01109	0,5-1,0	7,7	0,8	-	25	9,5	1,07	
01110	1,5-2,5			-			1,16	
01111	4-6	9,5	1,2	-	27	12	1,50	

**Insulated receptacles 0,5-6 mm<sup>2</sup>**

in acc. with DIN 46245 part 1-3

with flared insulation sleeve without metallic insulation enclosure

Material: brass, tinned

Insulation sleeve: PC, free of halogen

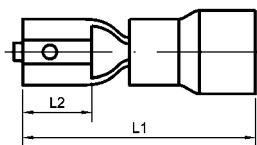
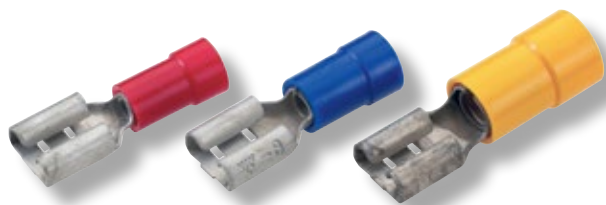

Part-No.	cross-section mm <sup>2</sup>	tab-width mm	DIN-size	tab-thickness mm	dimensions mm		weight kg/‰ pcs.	crimping-tools/page no.
					L <sub>1</sub>	L <sub>2</sub>		
30024	0,5-1,0	2,8	A 2,8 - 1	0,5	18,6	8	0,60	12600/N, 12601, 05180 page no. 152 12858, 05160/61/62 page no. 153 12430, 12408 page no. 158 12425 page no. 159 12230 page no. 156
30025			B 2,8 - 1	0,8			0,60	
30026	0,5-1,0	6,3	6,3 - 1	0,8	20	7,4	0,96	
30028	1,5-2,5		6,3 - 2,5				1,06	
30029	4-6		6,3 - 6		24		1,83	

**Fully insulated receptacles 0,5-2,5 mm<sup>2</sup>**

with add. metallic insulation enclosure

Material: brass, tinned

Insulation sleeve: PVC

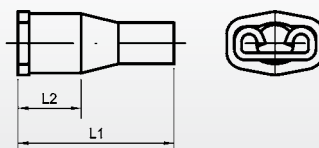
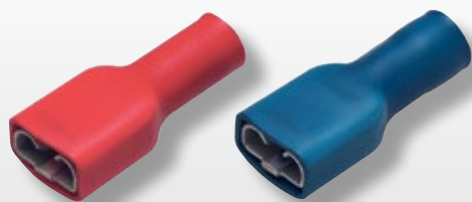

Part-No.	cross-section mm <sup>2</sup>	tab-width mm	tab-thickness mm	dimensions mm		weight kg/‰ pcs.	crimping-tools/page no.
				L <sub>1</sub>	L <sub>2</sub>		
30001	0,5-1,0	6,3	0,8	21	7,4	0,82	pages no. 152, 153, 156-159
30002	1,5-2,5					0,91	

**Fully insulated receptacles 0,5-6 mm<sup>2</sup>**

without metallic insulation enclosure

Material: brass, tinned

Insulation sleeve: PA or PC, free of halogen

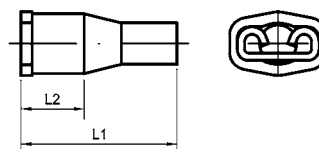

Part-No.	cross-section mm <sup>2</sup>	tab-width mm	tab-thickness mm	dimensions mm		weight kg/‰ pcs.	crimping-tools/page no.
				L <sub>1</sub>	L <sub>2</sub>		
30003	0,5 - 1,0	2,8	0,5	19,3	8	1,10	12600/N, 12601, 05180 page no. 152 12858, 05160/61/62 page no. 153 12430, 12408 page no. 158 12425 page no. 159
30010			0,8			1,10	
30011	0,5 - 1,0	4,8	0,5	20,2	6	1,15	
30013	1,5 - 2,5					1,20	
30012	0,5 - 1,0		0,8			1,15	
30014	1,5 - 2,5					1,20	
30018	0,5 - 1,0	6,3	0,8	21	7,4	1,23	
30020	1,5 - 2,5					1,32	
30022	4 - 6			26		2,15	

**Insulated multiple tabs 0,5-2,5 mm<sup>2</sup>**

with add. metallic insulation enclosure

Material: brass, tinned

Insulation sleeve: PVC

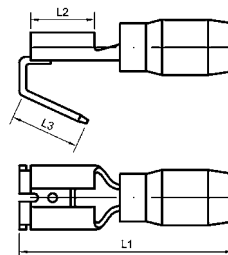
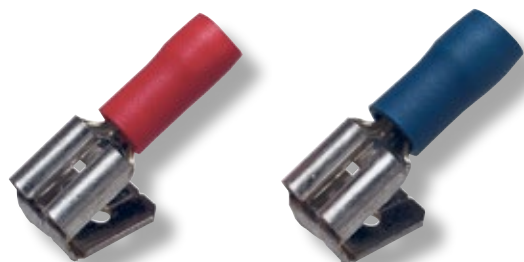

Part-No.	cross-section mm <sup>2</sup>	tab-width mm	tab-thickness mm	dimensions mm			weight kg/‰ pcs.	crimping-tools/page no.
				L <sub>1</sub>	L <sub>2</sub>	L <sub>3</sub>		
01117	0,5 - 1,0	6,3	0,8	22	7,5	8	1,12	pages no. 152, 153, 156-159
01118	1,5 - 2,5						1,12	

**Insulated tabs 0,5-6 mm<sup>2</sup>**

with add. metallic insulation enclosure

Material: brass, tinned

Insulation sleeve: PVC

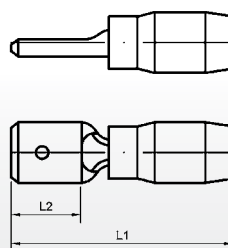

Part-No.	cross-section mm <sup>2</sup>	tab-width mm	tab-thickness mm	dimensions mm		weight kg/‰ pcs.	crimping-tools/page no.
				L <sub>1</sub>	L <sub>2</sub>		
01120	0,5 - 1,0	2,8	0,8	14,6	5,5	0,24	pages no. 152, 153, 156-159
01122	0,5 - 1,0	6,3	0,8	22	8	0,58	
01123	1,5 - 2,5					0,66	
01124	4 - 6					0,77	

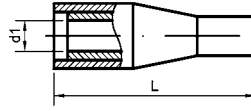
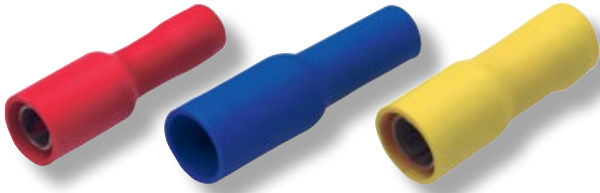

**Insulated female bullets 0,5-6 mm<sup>2</sup>**

 Material: bronze, tinned  
 Insulation sleeve: PVC

Part-No.	cross-section mm <sup>2</sup>	dimensions mm		weight kg/‰ pcs.	crimping-tools/page no.
		d <sub>1</sub>	L		
01130	0,5 - 1,0	4	22	0,56	12600/N, 12601, 05180 page no. 152 12858/05160/61/62 page no. 153 12430, 12408, 12425 page no. 158-159 12230 page no. 156
10005	1,5 - 2,5			1,20	
01131	1,5 - 2,5	5	22	1,20	
01133	4 - 6			1,24	

**Insulated male bullets 0,5-6 mm<sup>2</sup>**

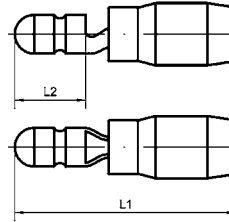
 Material: brass, tinned  
 Insulation sleeve: PVC

Part-No.	cross-section mm <sup>2</sup>	pin - Ø mm	dimensions mm		weight kg/‰ pcs.	crimping-tools/page no.
			L <sub>1</sub>	L <sub>2</sub>		
01140	0,5 - 1,0	4	22	9	0,60	12600/N, 12601, 05180 page no. 152 12858/05160/61/62 page no. 153 12430, 12408, 12425 page no. 158/59 12230 page no. 156
10015	1,5 - 2,5				1,50	
01141	1,5 - 2,5	5	22	9	0,75	
01142	4 - 6				0,89	

**Insulated receptacles and tabs 0,5-6 mm<sup>2</sup>**

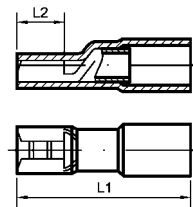
 shrinkable, with adhesive  
 Material: Cu-ETP, tinned  
 Insulation sleeve free of halogen

type I / receptacle

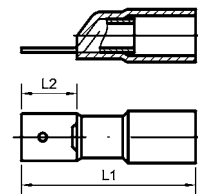

type II / tab

Part-No.	cross-section mm <sup>2</sup>	type	tab-width mm	tab-thickness mm	dimensions mm		weight kg/‰ pcs.	crimping-tools/page no.
					L <sub>1</sub>	L <sub>2</sub>		
11020	0,5 - 1,0	I	6,3	0,8	34,5	7,9	1,0	12601 page no. 152
11021	1,5 - 2,5				34,5		1,3	
11022	4 - 6				36,5		1,9	
11040	0,5 - 1,0	II	6,3	0,8	24,0	7,8	0,9	
11041	1,5 - 2,5				24,0		1,1	
11042	4 - 6				26,0		1,7	

Suitable to ensure waterproof connections. Shrink-ratio: 3:1, Shrinktemperature: &gt; + 100° C, operating temperature: -55° C up to + 125° C.

**Insulated cable lugs 0,5-6 mm<sup>2</sup> Ringtype,**

shrinkable with adhesive

Material: Cu-ETP, tinned

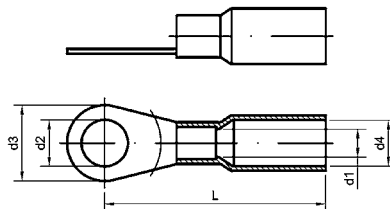

Part-No.	cross-section mm <sup>2</sup>	drilling M	dimensions mm					weight kg/% pcs.	crimping-tools/page no.
			d <sub>1</sub>	d <sub>2</sub>	d <sub>3</sub>	d <sub>4</sub>	L		
01172	0,5 - 1,0	4	1,6	4,3	8		24	1,5	12601 page no. 152
01173		5		5,3	10		23	1,0	
01174		6		6,4	11		27	1,1	
01175		8		8,4	14		23	1,2	
01176		10		10,5	17		17	1,1	
01179	1,5 - 2,5	4	2,3	4,3	8		24	1,0	
01180		5		5,3	10		26	1,1	
01181		6		6,5	11		27	1,3	
01182		8		8,4	14		28	1,6	
01183		10		10,5	18		30	2,2	
01186	4 - 6	4	3,6	4,3	8		30	1,9	
01187		5		5,3	10		31	2,0	
01188		6		6,5	11		32	2,1	
01189		8		8,4	14		34	2,6	
01190		10		10,5	18		35	3,1	

Suitable to ensure waterproof connections. Shrink-ratio: 3:1, Shrinktemperature: > + 100° C, operating temperature: -55° C up to + 125° C.  
Insulation sleeve free of halogen

**Insulated cable lugs 0,5-6 mm<sup>2</sup> Forktype,**

shrinkable with adhesive

Material: Cu-ETP, tinned

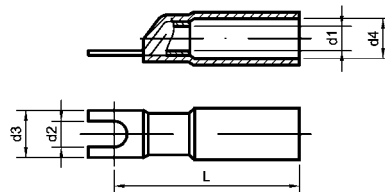

Part-No.	cross-section mm <sup>2</sup>	drilling M	dimensions mm					weight kg/% pcs.	crimping-tools/page no.
			d <sub>1</sub>	d <sub>2</sub>	d <sub>3</sub>	d <sub>4</sub>	L		
11000	0,5 - 1,0	4	1,6	4,3	6,4	4,8	23	0,8	12601 page no. 152
11001		5		5,3	9,5		24,2	0,9	
11004	1,5 - 2,5	4	2,3	4,3	6,4	5,5	23,5	0,9	
11005		5		5,3	9,4		25,6	1,1	
11008	4 - 6	4	3,6	4,3	9,5	7	27,5	2,0	
11009		5		5,3	9,5		27,5	2,1	

Suitable to ensure waterproof connections. Shrink-ratio: 3:1, Shrinktemperature: > + 100° C, operating temperature: -55° C up to + 125° C.  
Insulation sleeve free of halogen

**Insulated butt-connectors 0,1-6 mm<sup>2</sup>**

shrinkable with adhesive

Material: Cu-ETP, tinned

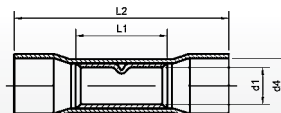
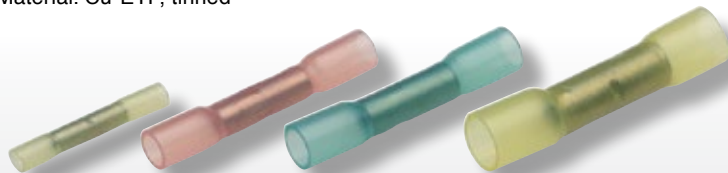

Part-No.	cross-section mm <sup>2</sup>	dimensions mm				weight kg/% pcs.	crimping-tools/page no.
		d <sub>1</sub>	d <sub>2</sub>	L <sub>1</sub>	L <sub>2</sub>		
01094	0,1 - 0,3	1,2	3,2	12,0	31,0	0,6	12601 page no. 152
01095	0,5 - 1,0	1,6	3,2	14,5	37,5	1,2	
01096	1,5 - 2,5	2,3	3,9	14,5	37,5	1,6	
01097	4 - 6	3,6	5,6	14,5	42,5	2,6	

Suitable to ensure waterproof connections. Shrink-ratio: 3:1, Shrinktemperature: > + 100° C, operating temperature: -55° C up to + 125° C.  
Insulation sleeve free of halogen

### Solder splices 0,3-6 mm<sup>2</sup>

shrinkable with adhesive

to ensure airtight and waterproof cable connections

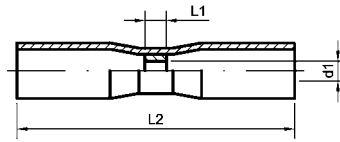
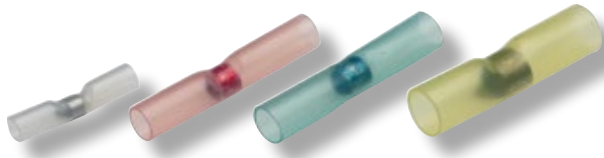

Part-No.	cross-section mm <sup>2</sup>	d <sub>1</sub>	dimensions mm			operating temperature	weight kg/ % Stck
			L <sub>1</sub>	L <sub>2</sub>			
01194	0,3 - 0,8	1,7	2,0	26	- 55° C bis + 95° C	0,22	
01195	0,8 - 2,0	2,7	3,4	42		0,66	
01196	2 - 4	4,5	4,0	42		0,76	
01197	4 - 6	6	4,5	42		1,36	

Solder splices with heat shrinkable tubing and adhesive. Suitable to ensure airtight and waterproof cable connections. The articles offer a combination out of solder and shrinkable connector and are outstandingly suitable to repair faulty cables in the field of the electro- and electronic industrie. The reliable protection against moisture and environmental prevent a corrosion and guarantee connections with an optimal electrical resistance. By using components under vibration a break of the cable caused through corrosion are excluded. So the solder splices offer tremendous advantages compared with usual repairing of damaged cables by using electrical tapes etc. By heating the solder splices you get the cable connection and the shrinking of the insulation tube with the adhesive in one handling operation. Caused by this one step process it is possible to reduce the repair costs. The pull out strength of the connection is 2,5 times higher compared with a pressed design.

#### Technical Data

Shrink ratio: 3:1  
 Shrink temperature: > + 120° C  
 Melting temp. solder alloy: + 126° C up to + 145° C  
 Dielectric strength of the insulation: 15 kV/mm

### Solder splice mounting-set



Part-No.	content	
01198	50 pcs. solder splices	0,3-0,8 mm <sup>2</sup> /01194
	25 pcs. "	0,8-2,0 mm <sup>2</sup> /01195
	20 pcs. "	1,5-2,5 mm <sup>2</sup> /01196
	10 pcs. "	2,0-4,0 mm <sup>2</sup> /01197
	1 pcs. soldering-iron (butane-gas) with reflector	
01199	Butane-fuel, 250 ml canister	

### Assortment boxes out of varnished steel sheet



Part-No.	dimensions mm	description
01316	245 x 160 x 45	Box without content without carry-grip with 6 little and 1 tool-partition
01317	350 x 160 x 35	Box without content with carry-grip, 7 little and 1 tool partition
01318	350 x 160 x 35	Box without content with carry-grip, 12 little and 1 tool-partition
01319	375 x 235 x 55	Box without content with carry-grip, 19 little and 1 tool-partition



# 1. ELECTRICAL CONNECTION- AND INSTALLATION TECHNIQUE

## 1.2 Uninsulated cable lugs and connectors

druseidt cable lugs and connectors acc. to the described chapter 1.2 are manufactured acc. to DIN 46234, DIN 46230 and DIN 46341 design A + B as well as usual in trade designs. They are applicable for stranded, fine stranded and also extremely fine stranded conductors. The cable lugs can be delivered in ring-type, fork-type, pin-type, as well as flag type design.

The connectors as parallel – but also as butt connectors. All terminals are manufactured out of copper with the highest conductivity. They are punched and the connecting sleeves are hard soldered. The tin plated surface offers a protection against oxidation and environmental influences. The crimping procedure should be done by a so called indent-crimping process acc. to the adjoining examples. Please pay attention to the fact that the indentor crimps the connectors only on the soldered seamed side of the crimping sleeves. In the cross-section range of 10 mm<sup>2</sup> or bigger it is necessary that the used tool left a visible cross-section stamping on the crimping sleeve. Also when working with multi-range tools the stamping has to mark the right range of the conductor cross-section on the crimping sleeve too.

Please notice that the crimpings will be done only with the right and suitable tools and die-sets.



Crimping design:  
Indent-crimping

**Cable lugs 0,1-35 mm<sup>2</sup>**  
 DIN 46234 and special design  
 Material: Cu-HCP, tinned

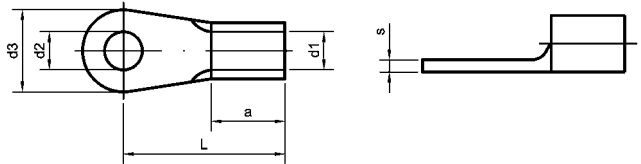

Part-No.	cross-section mm <sup>2</sup>	drilling M	DIN size	d <sub>1</sub>	d <sub>2</sub>	dimensions mm				weight kg/% pcs.	crimping-tools/page no.
						d <sub>3</sub>	L	a	s		
01340	0,1 - 0,5	2	2 - 0,5	1	2,2	5	10	4	0,5	0,21	05103 page no. 158 12645/N page no 158; 12858, 05160 page no 153 30445 page no 158
01341		3	3 - 0,5		3,2	5	10			0,19	
01342		4	4 - 0,5		4,3	6,5	12			0,24	
01343		5	5 - 0,5		5,3	8	11			0,24	
01345	0,5 - 1	2	-	1,6	2,2	6	11	5	0,8	0,59	
01346		2,5	2,5 - 1		2,7	6	11	5		0,58	
01347		3	3 - 1		3,2	6	11	5		0,56	
01349		3,5	3,5 - 1		3,7	6	11	5		0,55	
01351		4	-		4,3	6,5	8	4		0,42	
01352		4	-		4,3	7	11	5		0,58	
01353		4	4 - 1		4,3	8	12	5		0,70	
01354		5	-		5,3	8	12	5		0,65	
01355		5	5 - 1		5,3	10	13	5		0,90	
01356		6	-		6,5	10	13	5		0,85	
01357		6	-		6,5	12	17	5		1,10	
01358		8	-		8,4	12	17	5		1,00	
01359	1,5 - 2,5	3	3 - 2,5	2,3	3,2	6	11	5	0,8	0,63	
01360		3,5	3,5 - 2,5		3,7	6	11			0,62	
01362		4	-		4,3	6,8	11			0,63	
01363		4	4 - 2,5		4,3	8	12			0,78	
01364		5	-		5,3	8	12			0,70	
01365		5	5 - 2,5		5,3	10	14			0,90	
01366		6	-		6,5	10	14			0,85	
01367		6	6 - 2,5		6,5	11	16			1,06	
01368		8	8 - 2,5		8,4	14	17			1,30	
01369		10	-		10,5	18	20			2,00	
01370		12	-		13	18	20			1,70	
01371	4 - 6	4	4 - 6	3,6	4,3	8	14	6	1,0	1,40	
01372		5	5 - 6		5,3	10	15			1,60	
01373		6	6 - 6		6,5	11	16			1,70	
01374		8	8 - 6		8,4	14	19			2,20	
01375		10	10 - 6		10,5	18	21			2,80	
01376		12	-		13	18	21			2,50	
01377	10	4	-	4,5	4,3	10	16	8	1,1	2,30	
01378		5	5 - 10		5,3	10	16			2,25	
01379		6	6 - 10		6,5	11	17			2,40	
01380		8	8 - 10		8,4	14	20			2,90	
01381		10	10 - 10		10,5	18	21			3,40	
01382		12	12 - 10		13	22	23			4,20	
01383	16	5	5 - 16	5,8	5,3	11	20	10	1,2	3,90	
01384		6	6 - 16		6,5	11	20			3,80	
01385		8	8 - 16		8,4	14	22			4,30	
01386		10	10 - 16		10,5	18	24			5,00	
01387		12	12 - 16		13	22	26			6,00	
01388	25	5	5 - 25	7,5	5,3	12	25	11	1,5	7,00	
01389		6	6 - 25		6,5	12	25			6,90	
01390		8	8 - 25		8,4	16	25			7,50	
01391		10	10 - 25		10,5	18	26			8,00	
01392		12	12 - 25		13	22	31			9,20	
10080		16	16 - 25		17	28	35			12,50	
01393	35	6	6 - 35	9	6,5	15	26	12	1,6	10,10	
01394		8	8 - 35		8,4	16	26			9,80	
01395		10	10 - 35		10,5	18	27			10,00	
01396		12	12 - 35		13	22	31			12,60	
10085		16	16 - 35		17	28	36			14,70	

Tools with exchangeable crimping dies, pages no. 167 - 200

12650 page no 164; 12655 page no 165

05126 page no 153

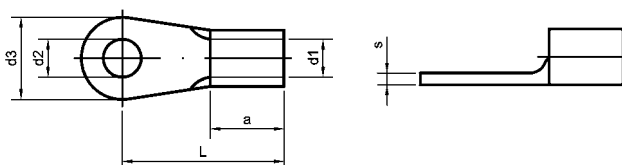
Cable lugs DIN 46234 50-240 mm<sup>2</sup>

Part-No.	cross-section mm <sup>2</sup>	drilling M	DIN size	dimensions mm						weight kg/‰ pcs.	crimping-tools/page no.					
				d <sub>1</sub>	d <sub>2</sub>	d <sub>3</sub>	L	a	s							
10090	50	6	6 - 50	11	6,5	18	34	16	1,8	17,00	12965/S, 12968 page no. 173; 13551/25, 13551/42, 13537 page no. 183; 12485, 12486, 12487 page no. 199; 12837 page no. 200	30460 page no. 167; 12930, 12933 page no. 171; 12748 page no. 179; 14242 page no. 177				
01397		8	8 - 50		8,4	18	34			16,50						
01398		10	10 - 50		10,5	18	34			16,00						
01399		12	12 - 50		13	22	36			18,00						
01400		16	16 - 50		17	28	40			21,00						
10091	70	6	-	13	6,5	22	38	18	2	26,00			31460 page no. 169	14240/41 page no. 177; 13552 page no. 181; 12836 page no. 199		
01401		8	8 - 70		8,4	22	38			26,00						
01402		10	10 - 70		10,5	22	38			25,00						
01403		12	12 - 70		13	22	38			24,00						
01404		16	16 - 70		17	28	42			27,00						
10092	95	8	8 - 95	15	8,4	24	42	20	2,5	41,00						
01405		10	10 - 95		10,5	24	42			41,00						
01406		12	12 - 95		13	24	42			39,00						
01407		16	16 - 95		17	28	44			41,00						
10093		120	8	8 - 120	17	8,4	24	44		22					3	56,00
01408	10		10 - 120		10,5	24	44		56,00							
01409	12		12 - 120		13	24	44		54,00							
01410	16		16 - 120		17	28	48		58,00							
10095	150		10	10 - 150	19	10,5	30	50	24	3,2			77,00			
01411		12	12 - 150		13	30	50		76,00							
01412		16	16 - 150		17	30	50		75,00							
10097	185	10	-	21	10,5	36	50	28	3,5	147,00						
01413		12	12 - 185		13	36	50			147,00						
01414		16	16 - 185		17	36	50			143,00						
01416		240	12	12 - 240	23,5	13	38	56		32			4		235,00	
01417	16		16 - 240		17	38	56		234,00							

Cable lugs 0,1-16 mm<sup>2</sup>

Fork-Type,

Material: Cu-HCP tinned

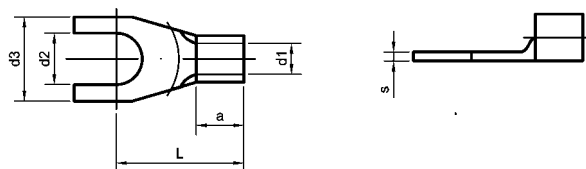

Part-No.	cross-section mm <sup>2</sup>	drilling M	dimensions mm						weight kg/‰ pcs.	crimping-tools/page no.				
			d <sub>1</sub>	d <sub>2</sub>	d <sub>3</sub>	L	a	s						
01430	0,1 - 0,5	3	1	3,2	5	10	4	0,5	0,21	05103 page no. 158	05182 page no. 158; 12430, 12408, 12425 pages no. 158/159			
01431	0,5 - 1,0	3	1,6	3,2	6	11	5	0,8	0,56			30446 from 1,5 mm <sup>2</sup> page no. 158		
01432		3		3,2	6,5	8	4		0,56					
01433	3,5		3,7	6	11	5		0,56						
01434	3,5		3,7	6,5	8	4		0,70						
01435	1,5 - 2,5	4		4,3	6,8	11	5		0,70				30445 page no. 160	12645/N page no. 158; 12858, 05160 page no. 160
01436		4		4,3	8	12	5		0,70					
01437		5		5,3	10	13	5		0,90					
01438		6		6,5	12	17	5		0,76					
01439	4 - 6	3	2,3	3,2	6	11	5	0,8	0,63					
01440		3,5		3,7	6,8	11			0,63					
01441		4		4,3	6,8	11			0,78					
01442		4		4,3	8	12			0,78					
01443		5		5,3	10	14			0,90					
01444		6		6,5	11	16			1,06					
01445		10	4	3,6	4,3	8	14	6	1,0	1,40	05126 page no. 160			
01446			5		5,3	10	15			1,60				
01447	6			6,5	11	16			1,70					
01448	8			8,4	14	19			2,20					
01449	16	5	4,5	5,3	10	16	8	1,1	3,90					
01450		6		6,5	11	17			3,80					
01452		6		5,8	6,5	11	20	10	1,2				3,80	
01453	8		8,4	14	22			5,00						



**Cable lugs 10-300 mm<sup>2</sup>**

Material: Cu-HCP, tinned

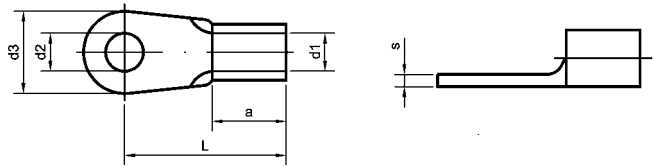

Part-No.	cross-section mm <sup>2</sup>	size	dimensions mm						weight kg/% pcs.	crimping-tools/page no.
			d <sub>1</sub>	d <sub>2</sub>	d <sub>3</sub>	a	L	s		
01501	10	6 x 4,3	4,3	6,4	11	10	21	1	2,52	on request
01502		8 x 4,3		8,4	15		24		3,18	
01503		10 x 4,3		10,5	19		26		4,10	
01504		12 x 4,3		13	22		28		4,50	
01506	16	6 x 5,4	5,4	6,4	11	11,5	24	1	3,46	
01507		8 x 5,4		8,4	15		27		4,20	
01508		10 x 5,4		10,5	19		29		4,90	
01509		12 x 5,4		13	22		31		5,50	
01510	25	6 x 6,8	6,8	6,4	13	13,5	27	1,2	5,91	
01511		8 x 6,8		8,4	15		30		6,50	
01512		10 x 6,8		10,5	19		32		7,50	
01513		12 x 6,8		13	22		35		8,40	
01516	35	8 x 8,2	8,2	8,4	15	16	33	1,5	10,64	
01517		10 x 8,2		10,5	19		35		11,70	
01518		12 x 8,2		13	22		38		13,50	
01521	50	8 x 9,5	9,5	8,4	17	19	36	1,8	16,89	
01522		10 x 9,5		10,5	19		38		17,50	
01523		12 x 9,5		13	22		41		18,90	
01525	70	8 x 11,2	11,2	8,4	21	24	44	2	27,70	
01526		10 x 11,2		10,5	21		44		27,50	
01527		12 x 11,2		13	22		47		29,60	
01528		16 x 11,2		17	28		50		33,10	
01530	95	10 x 13,5	13,5	10,5	21	24	44	2,5	39,20	
01531		12 x 13,5		13	22		47		40,70	
01533	120	12 x 15	15	13	24	29	53	3	63,10	
01534		16 x 15		17	28		55		65,30	
01536	150	12 x 16,5	16,5	13	28	29	55	3,5	84,50	
01537		16 x 16,5		17	28		55		83,20	
01538	185	12 x 18,5	18,5	13	28	34	61	4	116,80	
01539		16 x 18,5		17	28		61		114,40	
01540	240	12 x 21	21	13	30	40	68	5	189,00	
01541		16 x 21		17	30		68		186,00	
01542	300	12 x 23,5	23,5	13	30	40	68	5	200,40	
01543		16 x 23,5		17	30		68		200,40	

**Parallel connectors 0,5-150 mm<sup>2</sup>**

DIN 46341 part 1, design A

Material: Cu-HCP, tinned

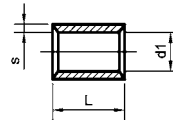

Part-No.	cross-section mm <sup>2</sup>	DIN size	dimensions mm			weight kg/% pcs.	crimping-tools/page no.
			d <sub>1</sub>	L	s		
01760	0,5 - 1,0	A - 1	1,6	7	0,8	0,40	crimping-tools page no. 153, 156, 157, 158, 159, 164, 165, 167, 169, 181, 183, 199
01761	1,5 - 2,5	A - 2,5	2,3	7	0,8	0,50	
01762	4 - 6	A - 6	3,6	7	1	0,90	
01763	10	A - 10	4,6	9	1,1	1,64	
01764	16	A - 16	5,9	10	1,2	2,52	
01765	25	A - 25	7,7	12,5	1,5	5,17	
01766	35	A - 35	9,2	14	1,6	7,22	
01767	50	A - 50	11,2	17,5	1,8	12,56	
01768	70	A - 70	13,5	18	2	16,56	
01769	95	A - 95	15	19	2,5	24,43	
01770	120	A - 120	16,7	21	3	37,70	
01771	150	A - 150	19	25	3,2	50,24	

**Butt connectors 0,5-150 mm<sup>2</sup>**

DIN 46341 part 1, design B

Material: Cu-HCP, tinned

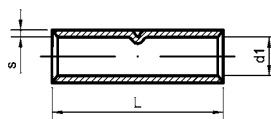

Part-No.	cross-section mm <sup>2</sup>	DIN size	dimensions mm			weight kg/‰ pcs.	crimping-tools/page no.
			d <sub>1</sub>	L	s		
01740	0,5-1,0	B - 1	1,6	15	0,8	0,90	crimping-tools page no. 153, 156, 157, 158, 159, 164, 165, 167, 169, 171, 177, 181, 183, 199
01741	1,5-2,5	B - 2,5	2,3	15	0,8	1,10	
01742	4-6	B - 6	3,6	15	1	2,60	
01743	10	B - 10	4,6	20	1,1	3,64	
01744	16	B - 16	5,9	26	1,2	6,14	
01745	25	B - 25	7,7	29	1,5	11,33	
01746	35	B - 35	9,2	32	1,6	15,34	
01747	50	B - 50	11,2	38	1,8	24,44	
01748	70	B - 70	13,5	42	2	37,36	
01749	95	B - 95	15	48	2,5	60,80	
01750	120	B - 120	16,7	52	3	86,68	
01751	150	B - 150	19	56	3,2	112,50	

**Solder tags 0,5-95 mm<sup>2</sup>**

DIN 46211 design A and special design

Material: brass, tinned

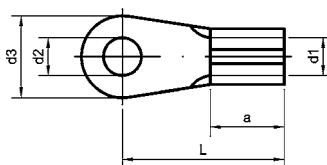

Part-No.	cross-section mm <sup>2</sup>	drilling M	DIN size	dimensions mm					weight kg/‰ pcs.
				d <sub>1</sub>	d <sub>2</sub>	d <sub>3</sub>	a	L	
03331	0,5-1,0	3	3 x 1,4	1,4	3,2	6	3,5	10	0,25
03332		4	4 x 1,4		4,3	8		11,5	0,32
03333		5	5 x 1,4		5,3	10		13	0,42
03336	1,5-2,5	4	4 x 2,3	2,3	4,3	8	6	14,5	0,90
03337		5	5 x 2,3		5,3	10		16	1,10
03338		6	6 x 2,3		6,5	11		17	1,14
03339		8	8 x 2,3		8,4	15		20	1,65
03341	4-6	5	5 x 3,4	3,4	5,3	10	8	18	1,80
03342		6	6 x 3,4		6,5	11		19	1,90
03343		8	8 x 3,4		8,4	15		23	2,70
03344		10	10 x 3,4		10,5	19		24	3,30
03346	10	5	5 x 4,3	4,3	5,3	10	10	19	3,00
03347		6	6 x 4,3		6,5	11		21	3,10
03348		8	8 x 4,3		8,4	15		24	4,00
03349		10	10 x 4,3		10,5	19		26	4,90
03351	16	6	6 x 5,4	5,4	6,5	11	11,5	24	5,10
03352		8	8 x 5,4		8,4	15		27	6,10
03353		10	10 x 5,4		10,5	19		29	7,30
03354		12	12 x 5,4		13	22		31	8,50
03355	25	6	6 x 6,8	6,8	6,5	13	13,5	27	9,00
03356		8	8 x 6,8		8,4	15		30	10,00
03357		10	10 x 6,8		10,5	19		32	11,10
03358		12	12 x 6,8		13	22		35	12,50
03360	35	8	8 x 8,2	8,2	8,4	15	16	33	14,50
03361		10	10 x 8,2		10,5	19		35	15,70
03362		12	12 x 8,2		13	22		38	17,40
03365	50	8	8 x 9,5	9,5	8,4	17	19	36	23,60
03366		10	10 x 9,5		10,5	19		38	24,50
03367		12	12 x 9,5		13	22		41	26,70
03369	70	10	10 x 11,2	11,2	10,5	21	24	44	42,50
03370		12	12 x 11,2		13	22		47	43,50
03372	95	10	10 x 13,5	13,5	10,5	21	24	44	54,40
03373		12	12 x 13,5		13	22		47	55,40

**Pin connectors 0,5-95 mm<sup>2</sup>**

DIN 46230 and special design

Material: Cu-ETP, tinned

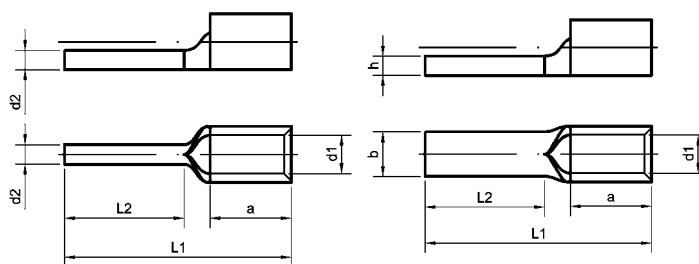

01779-01783

01784-01792

Part-No.	cross-section mm <sup>2</sup>	DIN size	dimensions							weight kg/% pcs.	crimping-tools/page no.
			d <sub>1</sub>	d <sub>2</sub>	b	h	a	L <sub>1</sub>	L <sub>2</sub>		
01779	0,1-0,5	A 0,5	1	1,4	-	-	4	14	8	0,20	crimping-tools page no. 153, 156, 157, 158, 159, 164, 165, 167, 169, 171, 177, 181, 183, 199
01780	0,5-1,0	A 1	1,6	1,9	-	-	5	17	10	0,60	
01781	1,5-2,5	-	2,3	1,9	-	-	5	13,5	5	0,54	
01782	1,5-2,5	A 2,5	2,3	1,9	-	-	5	17	10	0,65	
01783	4-6	A 6	3,6	2,7	-	-	6	20	11	1,61	
01784	10	-	4,5	-	4,3	2,4	10	24,5	11	2,63	
01785	10	B 10	4,5	-	4,5	2	8	22	12	2,60	
01786	16	-	5,4	-	5,5	2	11,5	29,5	15	3,89	
01787	16	B 16	5,8	-	5,5	2,6	10	26	13	4,40	
01788	25	-	6,7	-	6,8	2,4	13,5	33,5	15	6,30	
01789	35	-	8,4	-	8	3,2	16	40,5	20	11,70	
01790	50	-	9,5	-	9,5	3,6	19	45	20	17,87	
01791	70	-	11,2	-	11	4	24	55	23	29,20	
01792	95	-	13,5	-	12,5	5	24	55	23	42,90	

**Flag type cable lugs 10-150 mm<sup>2</sup>**

Material : Cu-ETP, tinned and soldered

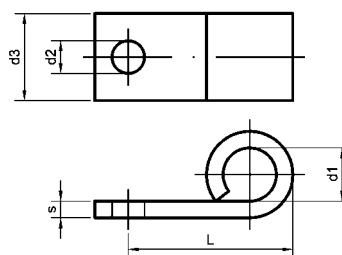

Part-No.	cross-section mm <sup>2</sup>	drilling M	dimensions mm					weight kg/% pcs.	crimping-tools/page no.	
			d <sub>1</sub>	d <sub>2</sub>	d <sub>3</sub>	L	s			
10118	10	5	5	5,3	10,5	20	1,2	0,45	on request	
01553		6		6,5	10,5	17		0,41		
01554		8		8,4	17	17		0,34		
01555	16	6	5,5	6,5	16	19	1,2	0,75		
01556		8		8,4	16	19		0,72		
01557		10		10,5	21	20		1,00		
01558		12		13	21	20		0,95		
01559	25	6	7	6,5	18	21	1,5	1,15		
01560		8		8,4	18	23		1,20		
10120		10		10,5	24	23		1,94		
01561	35	8	8,5	8,4	20	23	1,7	1,56		
01562		10		10,5	20	26		1,70		
01563		12		13	20	26		1,62		
01564	50	8	10	8,4	23	30	2	2,82		
01565		10		10,5	23	30		2,64		
10125		12		13	23	28		2,40		
01566	70	8	12	8,4	26	32	2,5	4,00		
01567		10		10,5	26	32		3,60		
01568		12		13	26	33		3,40		
01569	95	12		13,5	13	27	36	2,5		5,25
01570	120	12		15	13	27	40	3		7,20
01571	150	12		17	13	30	40	3,2		8,40
01572		16		17	30	40		8,35		



# 1. ELECTRICAL CONNECTION- AND INSTALLATION TECHNIQUE

## 1.3 Uninsulated tubular cable lugs and connectors, druseidt standard design

druseidt delivers tubular cable lugs and connectors made out of copper in different tube dimensions. So the following described standard design, made out of copper tube HCP resp. ETP acc. to DIN 13600, are delivered since decades. The surface of all terminals are tin plated and protect them against environmental influences and corrosion.

Material with exact dimension (diameter/thickness) and the manufacturing of correct fitted connectors guarantee an optimal and safety processability of all druseidt cable lugs. The crimping procedure should be done by a so called WM-crimping. This crimping design enables an intensive compressing to the center of the conductor, also when working with fine stranded cables.

Please notice that the crimping procedures will be done only with the right tools suitable for druseidt tubular cable lugs and connectors in standard design.

The number of the crimping procedures depends on the crimping width resp. the cross-section and the length of the connector sleeve. More detailed information are given on the catalogue page 202. druseidt tubular cable lugs and connectors are suitable for application up to a temperature of + 120° C (cf DIN 46234 too).



Crimping design:  
WM-crimping

**Tubular cable lugs 0,75-50 mm<sup>2</sup>**

druseidt standard design,  
Material: Cu-HCP DIN EN 13600  
Surface: tinned

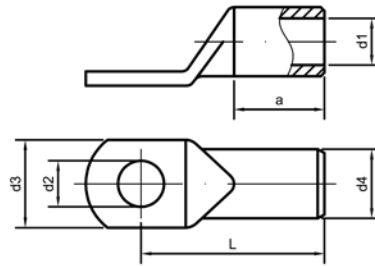

Part-No.		cross-section mm <sup>2</sup>	drilling M	dimensions mm						weight kg/% pcs.	crimping-tools/page no.	
without inspection hole	with inspection hole			d <sub>1</sub>	d <sub>2</sub>	d <sub>3</sub>	d <sub>4</sub>	L	a			
01580	-	0,75	3	1,4	3,2	6,5	3	12,5	6	0,71	30445 0,75-10 mm <sup>2</sup> 30446 1,5-16 mm <sup>2</sup> page no. 160	
01581	-		4		4,3	8,5		14		0,80		
01582	-		5		5,3	10		15		1,00		
01583	-	1,5	3	1,9	3,2	6,5	3,9	14	6	1,18		
01584	-		4		4,3	8,5		15		1,34		
01585	-		5		5,3	10		16		1,45		
01586	-		6		6,4	11		18		1,69		
01588	-	2,5	4	2,4	4,3	8,5	4,4	15	6,5	1,57		
01589	-		5		5,3	10		16		1,72		
01590	-		6		6,4	11		18		1,92		
01591	-		8		8,4	13		20		2,20		
01592	-	4	4	3	4,3	8,5	5	17	8	2,20		
01593	-		5		5,3	10		18		2,40		
01594	-		6		6,4	11		20		2,60		
01595	-		8		8,4	14		22		3,00		
01596	-	6	4	3,7	4,3	8,5	5,5	17,5	8	2,40		
01597	-		5		5,3	10		19		2,60		
01598	-		6		6,4	11		21		2,80		
01599	-		8		8,4	14		23		3,00		
10129	10156	10	4	4,3	4,3	10	6,7	19,5	10	4,10		12375, 12376 page no. 161; 12655 page no. 165
01600	01680		5		5,3	10		20,5		4,30		
01601	01681		6		6,4	11		22,5		4,80		
01602	01682		8		8,4	15		25		5,30		
01603	01683		10		10,5	18		27,5		5,70		
01604	01684		12		13	19		28,5		5,80		
01605	01685	16	5	5,4	5,3	12	7,8	22,5	11	5,70		
01606	01686		6		6,4	12		24,5		6,40		
01607	01687		8		8,4	15		26,5		6,70		
01608	01688		10		10,5	18		29		7,20		
01609	01689		12		13	20		30		7,20		
10130	-	25	5	6,9	5,3	14	9,4	25	13	8,70		
01610	01690		6		6,4	14		27		9,50		
01611	01691		8		8,4	15		29		10,10		
01612	01692		10		10,5	18		31,5		10,90		
01613	01693		12		13	20		32,5		10,80		
10132	10158		14		15	22		34,5		11,60		
10133	10159	35	5	8,3	5,3	16,5	11,3	32,5	16	16,00		
01614	01694		6		6,4	16,5		32,5		16,00		
01615	01695		8		8,4	16,5		33		16,20		
01616	01696		10		10,5	18		35,5		18,00		
01617	01697		12		13	20		36,5		17,00		
10134	10160		14		15	22		39		18,70		
10135	10162		16		17	26		41,5		19,70		
10140	10163	50	6	9,6	6,4	19	13,1	36	18	23,50		
01618	01698		8		8,4	19		37		24,10		
01619	01699		10		10,5	20		39		25,30		
01620	01700		12		13	23		40,5		26,10		
10136	10164		14		15	25		42,5		27,90		
01621	01701		16		17	27		45,5		29,40		
10137	10165		20		21	28		50		35,70		

12377 page no. 161; 12869 page no. 162; 12724 page no. 190; 30460 page no. 167; 31460 page no. 169;  
12930, 12933 page no. 171;  
12766 page no. 172; 12965/S, 12968 page no. 173; 14240/41 page no. 177; 12748 page no. 179;  
13552 page no. 181; 13551/25, 13557 page no. 183; 12725 page no. 186; 12728 page no. 188;  
12836, 12485-87, 05256 page no. 199; 12837 page no. 200

**Tubular cable lugs 70-630 mm<sup>2</sup>**

druseidt standard design,

Material: Cu-HCP DIN EN 13600

Surface: tinned

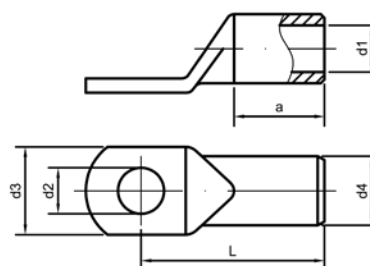

Part-No.		cross-section mm <sup>2</sup>	drilling M	dimensions mm						weight kg/‰ pcs.	crimping-tools/page no.								
without inspection hole	with inspection hole			d <sub>1</sub>	d <sub>2</sub>	d <sub>3</sub>	d <sub>4</sub>	L	a										
10138	10166	70	6	11,5	6,4	22,5	15,3	41	21	34,60	05256 page no. 199	12869 page no. 162	12766 page no. 172; 12965/S; 12968 page no. 173; 14240/41 page no. 177; 12748 page no. 179; 13552 page no. 181; 12724 page no. 190 13551/25; 13551/42; 13537 page no. 183; 12836; 12485-87 page no. 199; 12837 page no. 200	12377 page no. 161; 30460 page no. 167; 12725 page no. 186	31460 page no. 169; 12930; 12933 page no. 171; 12728 page no. 188				
01622	01702		8		8,4	22,5		41		34,60									
01623	01703		10			10,5	22,5		42,5							36,30			
01624	01704		12			13	23		43,5							36,40			
10139	10167		14			15	26		46							39,30			
01625	01705		16			17	28		48,5							40,20			
10141	10168	20			21	29		53		42,10									
10143	10169	95	6	13,5	6,4	25	17,5	46	23	47,10									
01626	01706		8		8,4	25		45,5								47,60			
01627	01707		10		10,5	25		47								48,20			
01628	01708		12		13	26		47								48,20			
10144	10170		14		15	26		49								51,60			
01629	01709		16		17	28		50								51,50			
10146	10171	20		21	31		54,5			56,60									
10147	10172	120	8	15,5	8,4	29	20	50,5	26	66,00									
01630	01710		10		10,5	29		53								71,30			
01631	01711		12		13	29		52,5								71,40			
10148	10173		14		15	29		53,5								72,40			
01632	01712		16		17	29		55								73,10			
01633	01713		20		21	35		60								78,10			
01634	01714	150	10	16,8	10,5	31	21,3	56,5	29	83,40									
01635	01715		12		13	31		56			81,80								
10149	10174		14		15	31		57			83,30								
01636	01716		16		17	31		58			85,00								
01637	01717		20		21	35		63			88,40								
10145	10175		185	10	19	10,5	35	24	59	30	106,10								
01638	01718	12			13	35		58,5			106,10								
10151	10176	14			15	35		61			107,20								
01639	01719	16			17	35		63			108,60								
01640	01720	20			21	35		66			113,30								
10152	10177	240		10	21	10,5	38	26	67	35	129,70								
01641	01721		12		13	38		67			130,20								
10153	10178		14		15	38		69			133,60								
01642	01722		16		17	38		69,5			138,40								
01643	01723		20		21	38		71			139,50								
01644	01724		300	12	24	13	44	30	82	42	217,20								
10154	10190	14			15	44		84			221,90								
01645	01725	16			17	44		85			219,40								
01646	01726	20			21	44		85			229,20								
10155	-	400		10	27,5	10,5	49	33,5	92	47	279,00								
10150	-			12		13	49		92			279,00							
01647	-		16		17	49		92			279,00								
01648	-		20		21	49		92			281,90								
01649	-		500	16	31	17	55,5	38	113	70	493,80								
01650	-			20		21	55,5		113			485,60							
01651	-	630	16	34	17	60	41	115	70	513,50									
01652	-		20		21	60		115			506,00								



**Tubular cable lugs 0,75-150 mm<sup>2</sup> druseidt standard design Angle type 90°**

Material: Cu-HCP DIN EN 13600 Surface: tinned

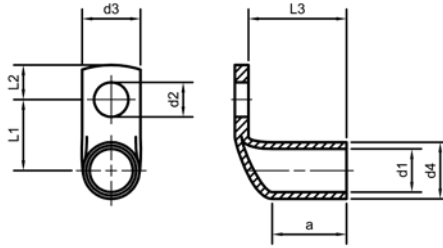

Part-No.		cross-section mm <sup>2</sup>	drilling M	dimensions mm								weight kg/% pcs.	crimping-tools/page no.
without inspection hole	with inspection hole			d <sub>1</sub>	d <sub>2</sub>	d <sub>3</sub>	d <sub>4</sub>	L <sub>1</sub>	L <sub>2</sub>	L <sub>3</sub>	a		
10400	-	0,5-0,75	3	1,4	3,2	6,5	3	7,5	4	9,5	5	0,90	30445 0,75-10 mm <sup>2</sup> , 30446 1,5-16 mm <sup>2</sup> page no. 160
10402	-		4		4,3	8,5		8,5	5			1,00	
10404	-		5		5,3	10		9,5	5,5			1,00	
10406	-	1-1,5	3	1,9	3,2	6,5	3,9	8	4	9,5	5	1,60	
10408	-		4		4,3	8,5		9	5			1,60	
10410	-		5		5,3	10		10	5,5			1,60	
10412	-		6		6,4	11		12	7,5			1,60	
10414	-	2,5	4	2,4	4,3	8,5	4,4	9,2	5	9,5	5,5	1,83	
10416	-		5		5,3	10		10,2	5,5			1,84	
10418	-		6		6,4	11		12,2	7,5			2,20	
10420	-		8		8,4	14		14,2	10			2,30	
10422	-	4	4	3	4,3	8,5	5	9,5	5	10,5	7	2,50	
10424	-		5		5,3	10		10,5	5,5			2,41	
10426	-		6		6,4	11		12,5	7,5			2,90	
10428	-		8		8,4	14		14,5	10	11,5		3,00	
10430	-	6	4	3,7	4,3	8,5	5,5	9,8	5	10,5	7	2,70	
10432	-		5		5,3	10		10,8	5,5			2,52	
10434	-		6		6,4	11		12,8	7,5			2,82	
10436	-		8		8,4	14		14,8	10			3,40	
10438	10838	10	5	4,3	5,3	10	6,7	11,4	5,5	15	9	4,90	
01800	01850		6		6,4	11		13,4	7,5			5,30	
01801	01851		8		8,4	15		15,4	10			5,40	
01802	01852		10		10,5	18		17,4	12			6,30	
01803	01853		12		13	20		18,4	13			5,61	
10440	10840	16	5	5,4	5,3	11	7,8	11,9	5,5	16,5	10	6,55	
01804	01854		6		6,4	11,5		13,9	7,5			6,96	
01805	01855		8		8,4	15		15,9	10			8,20	
01806	01856		10		10,5	18		17,9	12			8,20	
01807	01857		12		13	20		18,9	13			7,78	
01808	01858	25	6	6,9	6,4	14	9,4	14,7	7,5	21	12	11,27	
01809	01859		8		8,4	15		16,7	10			12,15	
01810	01860		10		10,5	18		18,7	12			11,84	
01811	01861		12		13	20		19,7	13			12,40	
01812	01862	35	6	8,3	6,4	16,5	11,3	16,2	7,5	21	15	17,64	
01813	01863		8		8,4	16,5		18,2	10			17,26	
01814	01864		10		10,5	18		20,2	12			18,00	
01815	01865		12		13	20		21,2	13			18,00	
10441	10841	50	6	9,6	6,4	19	13,1	17,1	7,5	26	17	26,28	
01816	01866		8		8,4	19		19,1	10			26,70	
01817	01867		10		10,5	20		21,1	12			29,90	
01818	01868		12		13	23		23,5	13			30,00	
10442	10842		16		17	27		25,1	16			30,00	
01819	01869	70	8	11,5	8,4	22	15,3	20,2	10	23,9	20	36,56	
01820	01870		10		10,5	22		22,2	12			38,38	
01821	01871		12		13	23		23,2	13			38,30	
10443	10843		16		17	27		26,2	16			39,46	
01822	01872	95	8	13,5	8,4	25	17,5	21,3	10	28	22	48,69	
01823	01873		10		10,5	25		23,3	12			52,70	
01824	01874		12		13	25		24,3	13			50,63	
10444	10844		16		17	28		27,3	16			52,51	
01825	01875	120	10	15,5	10,5	29	20	25	12	32	25	74,00	
01826	01876		12		13	29		26	13			73,25	
01827	01877		16		17	29		28,5	16			72,95	
01828	01878	150	10	16,8	10,5	31	21,3	25,7	12	34	28	80,70	
01829	01879		12		13	31		26,7	13			82,90	
01830	01880		16		17	31		29,7	16			85,00	
10445	10845		20		21	35		33,7	19			88,90	

12376 page no. 161

12375 page no. 159; 12655 page no. 165

12377 page no. 161; 30460 page no. 167; 12725 page no. 186

31460 page no. 169; 12930, 12933 page no. 171; 12766 page no. 172; 12869 page no. 162; 12724 page no. 190,  
12965/S; 12968 page no. 173; 14240/41 page no. 177; 12748 page no. 179; 13552 page no. 181;  
13551/25; 13551/42; 13537 page no. 183; 12728 page no. 188; 12836; 12485-87; 05256 page no. 199; 12837 page no. 200

**Tubular cable lugs 185-300 mm<sup>2</sup> druseidt standard design Angle type 90°**

Material: Cu-HCP DIN EN 13600 Surface: tinned

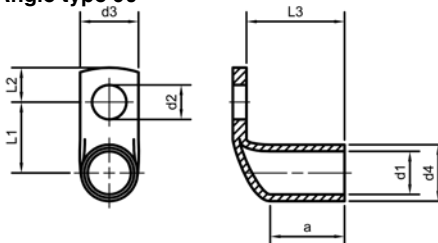

Part-No.		cross-section mm <sup>2</sup>	drilling M	dimensions mm								weight kg/‰ pcs.	crimping-tools/page no.
without inspection hole	with inspection hole			d <sub>1</sub>	d <sub>2</sub>	d <sub>3</sub>	d <sub>4</sub>	L <sub>1</sub>	L <sub>2</sub>	L <sub>3</sub>	a		
10446	10846	185	10	19	10,5	35	24	27	12	34,8	29	99,00	31460 page no. 169; 12930, 12933 page no. 171; 12766 page no. 172; 12965/S, 12968 page no. 173; 14240/41 page no. 177; 12748 page no. 179; 13552 page no. 181; 13551/25, 13551/42, 13537 page no. 183; 12728 page no. 188; 12836, 12485-87, 05256 page no. 199; 12837 page no. 200 12869 page no. 162 12724 page no. 190
01831	01881		12		13	35		28	13			101,40	
01832	01882		16		17	35		31	16			111,50	
01833	01883		20		21	35		35	19			115,80	
01834	01884	240	12	21	13	38	26	29	13	43	34	126,85	
01835	01885		16		17	38		32	16			134,55	
01836	01886		20		21	38		36	19			140,25	
01838	01888	300	12	24	13	43	30	31	13	51	41	198,20	
01840	01890		16		17	43		34	16			209,00	
01842	01892		20		21	43		38	19			218,10	

**Tubular cable lugs 10-240 mm<sup>2</sup> druseidt standard design Angle type 45°**

Material: Cu-HCP DIN EN 13600 Surface: tinned

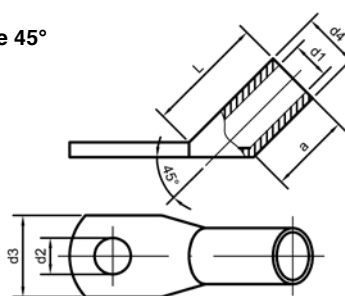

Part-No.	cross-section mm <sup>2</sup>	drilling M	d <sub>1</sub>	d <sub>2</sub>	dimensions mm		L	a	weight kg/‰ pcs.	crimping-tools/page no.
					d <sub>3</sub>	d <sub>4</sub>				
10438/S-45	10	5	4,3	5,3	10	6,7	15	9	4,90	31460 page no. 169; 12930, 12933 page no. 171; 12766 page no. 172; 12965/S, 12968 page no. 173; 14240/41 page no. 177; 12748 page no. 179; 13552 page no. 181; 13551/25, 13551/42, 13537 page no. 183; 12728 page no. 188; 12836, 12485-87, 05256 page no. 199; 12837 page no. 200; 12869 page no. 162; 12724 page no. 190
01800/S-45		6		6,4	11				5,40	
01801/S-45		8		8,4	15				5,90	
01804/S-45	16	6	5,4	6,4	11,5	7,8	16,5	10	6,90	
01805/S-45		8		8,4	15				7,08	
01806/S-45		10		10,5	18				8,20	
01808/S-45	25	6	6,9	6,4	14	9,4	20	12	10,44	
01809/S-45		8		8,4	15				11,30	
01810/S-45		10		10,5	18				11,97	
01811/S-45		12		13	20				12,17	
01812/S-45	35	6	8,3	6,4	16,5	11,3	24,5	15	18,09	
01813/S-45		8		8,4	16,5				18,75	
01814/S-45		10		10,5	18				19,51	
01815/S-45		12		13	20				19,73	
01816/S-45	50	8	9,6	8,4	19	13,1	28,5	17	28,50	
01817/S-45		10		10,5	20				32,70	
01818/S-45		12		13	23				34,14	
01819/S-45	70	8	11,5	8,4	22	15,3	33	20	40,24	
01820/S-45		10		10,5	22				42,96	
01821/S-45		12		13	23				42,48	
01822/S-45	95	8	13,5	8,4	25	17,5	38	22	53,80	
01823/S-45		10		10,5	25				56,80	
01824/S-45		12		13	25				57,40	
01825/S-45	120	10	15,5	10,5	29	20	43,5	25	83,25	
01826/S-45		12		13	29				81,50	
01827/S-45		16		17	29				85,92	
01828/S-45	150	10	16,8	10,5	31	21,3	47,5	28	98,70	
01829/S-45		12		13	31				96,80	
01830/S-45		16		17	31				101,20	
01831/S-45	185	12	19	13	35	24	51	29	122,90	
01832/S-45		16		17	35				119,60	
01833/S-45		20		21	35				139,90	
01834/S-45	240	12	21	13	38	26	61	34	155,80	
01835/S-45		16		17	38				165,10	
01836/S-45		20		21	38				170,40	

**Tubular cable lugs 0,5-16 mm<sup>2</sup>**

**druseidt standard design, Forktype**

Material: Cu-ETP resp. HCP DIN EN 13600 Surface: tinned

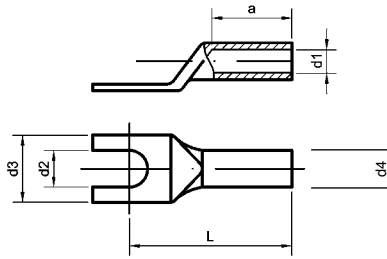

Part-No.	cross-section mm <sup>2</sup>	drilling M	dimensions mm				L	a	weight kg/‰ pcs.	crimping-tools/page no.
			d <sub>1</sub>	d <sub>2</sub>	d <sub>3</sub>	d <sub>4</sub>				
02100	0,5-0,75	3	1,4	3,2	6,5	3	12,5	6	0,70	30445 page no. 160 30446 page no. 160 12655 page no. 165 30460 page no. 167; 31460 page no. 169; 12930, 12933 page no. 171; 12725 p.no. 186; 12869 p.no. 162 12728 p.no. 188; 12724 p.no. 190
02101		4		4,3	8,5		14		0,70	
02102		5		5,3	10		15		0,75	
02105	1,0-1,5	4	1,9	4,3	8,5	3,9	15	6	1,17	
02106		5		5,3	10		16		1,30	
02107		6		6,4	11		18		1,39	
02110	2,5	4	2,4	4,3	8,5	4,4	15	6,5	1,48	
02111		5		5,3	10		16		1,55	
02112		6		6,4	11		18		1,63	
02113		8		8,4	13		20		1,91	
02115	4	4	3	4,3	8,5	5	17	8	1,81	
02116		5		5,3	10		18		2,06	
02117		6		6,4	11		20		2,16	
02118		8		8,4	14		22		2,31	
02121	6	4	3,7	4,3	8,5	5,5	17,5	8	2,07	
02122		5		5,3	10		19		2,25	
02123		6		6,4	11		21		2,49	
02124		8		8,4	14		23		2,58	
02127	10	5	4,3	5,3	10	6,7	20,5	10	3,96	
02128		6		6,4	11		22,5		4,17	
02129		8		8,4	15		25		4,57	
02132	16	5	5,4	5,3	12	7,8	22,5	11	5,25	
02133		6		6,4	12		24,5		5,56	
02134		8		8,4	15		26,5		6,00	
02137	16f	5	6	5,3	14	9	25,5	13	8,24	
02138		6		6,4	14		27		8,60	
02139		8		8,4	15		29,5		9,37	

**Butt connectors 0,5-630 mm<sup>2</sup>**

**druseidt standard design**

Material: Cu-ETP resp. HCP DIN EN 13600

Surface: tinned

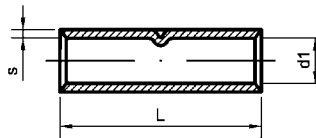

Part-No.	cross-section mm <sup>2</sup>	dimensions mm			weight kg/‰ pcs.	crimping-tools/page no.
		d <sub>1</sub>	L	s		
13686	0,5-0,75	1,4	15	0,8	0,80	page no. 160-162 165-200
13687	1,0-1,5	1,9	15	1	1,20	
13688	2,5	2,4	16	1	1,50	
13689	4	3	19	1	2,10	
13690	6	3,7	19	0,9	2,20	
13691	10	4,3	30	1,2	5,52	
13692	16	5,4	35	1,2	8,00	
13693	25	6,9	40	1,25	11,74	
13694	35	8,3	45	1,5	19,12	
13695	50	9,6	50	1,75	27,00	
13696	70	11,5	55	1,9	39,00	
13697	95	13,5	60	2	50,00	
13698	120	15,5	65	2,25	71,90	
13699	150	16,8	70	2,25	86,50	
01752	185	19	75	2,5	116,25	
01753	240	21	85	2,5	142,20	
01754	300	24	100	3	224,00	
01755	400	27,5	100	3	261,70	
01756	500	31	140	3,5	473,00	
01757	630	34	160	3,5	617,50	

# 1. ELECTRICAL CONNECTION- AND INSTALLATION TECHNIQUE

## 1.4 Uninsulated tubular cable lugs and connectors for fine stranded cables

Highly flexible, fine stranded copper cables and conductors are needed to transfer the current inside of smaller and smaller designed switch gears or switch devices as well as inside of plants under cramped conditions (conductors similar to our highly flexible silicone insulated leadings acc. to the following catalogue page 40).

Such conductors consist out of single wires with a diameter of 0,07-0,10 mm and have therefore some thousands thin wires inside. So the outside diameters of the stripped cables are bigger compared with standard conductors. To realize crimping-operations with cable lugs which have the same cross-section than the leadings, druseidt offers a serie of cable lugs and connectors especially coordinated with the dimension of such fine stranded leadings. Additionally to the straight designed cable lugs druseidt offers angle-types as well as cable lugs with smaller flange too.

Combined with our highly flexible silicone insulated leadings we offer the possibility to work with small and flexible connections also under extremely cramped conditions. We recommend to crimp such cable lugs with our special WM-crimping compression dies. This crimping design enables an intensive compressing to the center of the conductor, especially when working with fine stranded cables.

Please notice that the crimping procedures will be done only with the right tools and the right compression dies suitable for druseidt tubular cable lugs and connectors for fine stranded cables.

Crimping design:  
WM-crimping





**Tubular cable lugs 10f-240f mm<sup>2</sup>  
for fine stranded cables**

Material: Cu-HCP DIN EN 13600  
Surface: tinned

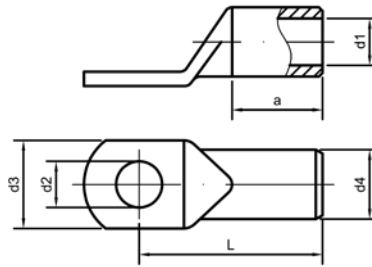

E 485326 up to 240f

Part-No.		cross-section mm <sup>2</sup>	drilling M	dimensions mm							weight kg/% pcs.	crimping-tools/page no.
without inspection hole	with inspection hole			d <sub>1</sub>	d <sub>2</sub>	d <sub>3</sub>	d <sub>4</sub>	L	a			
13650	13650/S	10f	5	5	5,3	12	8	23	12	7,00	12930, 12933, page no. 171; 12728 page no. 188, 12869 page no. 162	12374 page no. 162
13651	13651/S		6		6,4	12		25		7,60		
13652	13652/S		8		8,4	15		28		8,90		
13653	13653/S		10		10,5	18		31		9,70		
13654	13654/S		12		13	20		32		10,00		
10700	10700/S	16f	5	6	5,3	14	9	25,5	13	9,40		
13655	13655/S		6		6,4	14		27		10,10		
13656	13656/S		8		8,4	15		29,5		11,20		
13657	13657/S		10		10,5	18		32		11,20		
13658	13658/S		12		13	20		33		11,80		
13659	13659/S	25f	6	7,7	6,4	16	10,7	32	16	14,70		
13660	13660/S		8		8,4	16		34		14,30		
13661	13661/S		10		10,5	18		35		15,30		
13662	13662/S		12		13	20		36		16,10		
10702	10702/S	35f	6	9,2	6,4	18	12,4	36	18	20,70		
13663	13663/S		8		8,4	18		36		20,70		
13664	13664/S		10		10,5	18		38		21,40		
13665	13665/S		12		13	23		40		22,20		
13666	13666/S		16		17	28		45		22,10		
10704	10704/S	50f	6	11,2	6,4	22	14,8	42	21	32,00		
13667	13667/S		8		8,4	22		42		32,20		
13668	13668/S		10		10,5	22		43		33,10		
13669	13669/S		12		13	23		44		33,60		
13670	13670/S		16		17	28		48,5		36,50		
13671	13671/S	70f	8	13,5	8,4	25	17,5	45,5	23	48,00		
13672	13672/S		10		10,5	25		47		48,40		
13673	13673/S		12		13	26		47		48,40		
13674	13674/S		16		17	28		50		50,50		
10706	10706/S		20		21	31		54,5		55,20		
10707	10707/S	95f	8	15,5	8,4	29	20	50,5	26	65,60		
13675	13675/S		10		10,5	29		53		71,50		
13676	13676/S		12		13	29		52,5		69,80		
13677	13677/S		16		17	29		55		71,90		
13678	13678/S		20		21	35		60		76,10		
13679	13679/S	120f	10	16,8	10,5	31	21,3	56,5	29	80,70		
13680	13680/S		12		13	31		56		80,70		
13681	13681/S		16		17	31		58		83,60		
13682	13682/S		20		21	35		63		87,50		
10708	10708/S	150f	10	19	10,5	35	24	59	30	104,00		
13683	13683/S		12		13	35		58,5		107,00		
13684	13684/S		16		17	35		63		111,10		
13685	13685/S		20		21	35		66		119,60		
10710	10710/S	185f	10	21	10,5	38	26	67	29	135,90		
10711	10711/S		12		13	38		67		121,50		
10712	10712/S		16		17	38		69,5		129,80		
10713	10713/S		20		21	38		71		134,50		
10714	10714/S	240f	12	24	13	44	30	82	42	212,60		
10715	10715/S		16		17	44		82		219,40		
10716	10716/S		20		21	44		82		222,00		
10718	-	300f	12	27,5	13	49	33,5	92	47	279,00		
10719	-		16		17	49		92		279,00		
10720	-		20		21	49		92		281,90		

## Tubular cable lugs 10f-240f mm<sup>2</sup> Angle type 90° for fine stranded cables

Material: Cu-HCP DIN EN 13600

Surface: tinned

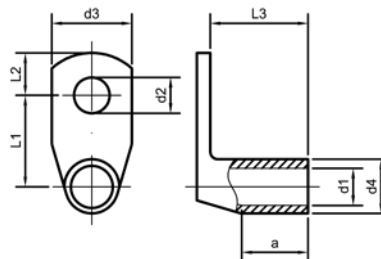

E 485326 up to 240f

Part-No.	cross-section mm <sup>2</sup>	drilling M	dimensions mm								weight kg/% pcs.	crimping-tools/page no.				
			d <sub>1</sub>	d <sub>2</sub>	d <sub>3</sub>	d <sub>4</sub>	L <sub>1</sub>	L <sub>2</sub>	L <sub>3</sub>	a						
03410	10f	5	5	5,3	12	8	12	5,5	17	11	8,60	12930, 12933, page no. 171; 12728 page no. 188; 12869 page no. 162	12766 page no. 172; 12965S/12968 page no. 173; 14240/41 page no. 177; 12748 page no. 179; 13552 page no. 181; 13551/25, 13551/42, 13537 page no. 183; 12836, 12485-87, 05256 page no. 199; 12837 page no. 200; 12724 page no. 190	31460 page no. 169	30460 page no. 167; 12725 page no. 186	12374 page no. 162
03412		6		6,4	13		14	7,5			8,70					
03414		8		8,4	15		16	10			9,40					
03416		10		10,5	18		18	12			9,70					
03418		12		13	20		19	13			9,80					
03420	16f	5	6	5,3	15	9	12,5	5,5	17	12	9,40					
03422		6		6,4	15		14,5	7,5			10,50					
03424		8		8,4	15		16,5	10			11,80					
03426		10		10,5	18		18,5	12			12,50					
03428		12		13	20		19,5	13			14,30					
03430	25f	6	7,7	6,4	16	10,7	15,9	7,5	20,8	15	15,50					
03432		8		8,4	16		17,9	10			18,00					
03434		10		10,5	18		19,9	12			18,80					
03436		12		13	20		20,9	13			16,90					
03440	35f	6	9,2	6,4	18	12,4	16,7	7,5	21,5	17	19,70					
03442		8		8,4	18		18,7	10			22,00					
03444		10		10,5	18,5		20,7	12			23,40					
03446		12		13	23		21,7	13			22,30					
03448		16		17	28		24,7	16			22,50					
03450	50f	6	11,2	6,4	22	14,8	17,9	7,5	24,5	20	29,00					
03452		8		8,4	22		19,9	10			31,50					
03454		10		10,5	22		21,9	12			33,00					
03456		12		13	23		22,9	13			33,80					
03458		16		17	28		25,9	16			35,70					
03460	70f	8	13,5	8,4	25	17,5	21,3	10	28	22	45,30					
03462		10		10,5	25		23,3	12			48,20					
03464		12		13	25		24,3	13			50,63					
03466		16		17	28		27,3	16			51,00					
03468		20		21	31		31,3	19			54,00					
03470	95f	10	15,5	10,5	29	20	25	12	32	25	75,00					
03472		12		13	29		26	13			72,20					
03474		16		17	29		28,5	16			75,00					
03476		20		21	35		32,5	19			77,00					
03480	120f	10	16,8	10,5	31	21,3	25,7	12	34	28	78,60					
03482		12		13	31		26,7	13			80,20					
03484		16		17	31		29,7	16			83,30					
03486		20		21	35		33,7	19			86,10					
03490	150f	10	19	10,5	35	24	27	12	34,8	29	100,60					
03492		12		13	35		28	13			107,00					
03494		16		17	35		31	16			110,40					
03496		20		21	35		35	19			119,60					
03497	185f	12	21	13	38	26	29	13	43	34	126,90					
03498		16		17	38		32	16			134,60					
03499		20		21	38		36	19			140,20					
03500	240f	12	24	13	43	30	31	13	51	41	199,20					
03501		16		17	43		34	16			209,00					
03502		20		21	43		38	19			218,10					
03504	300f	12	27,5	13	49	33,5	34,8	14,5	58	46	313,00					
03505		16		17	49						313,00					
03506		20		21	49						313,00					

**Butt connectors 10f-240f mm<sup>2</sup>  
for fine stranded cables**

Material: Cu-HCP DIN EN 13600  
Surface: tinned

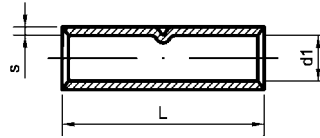

E 485326 up to 240f

Part-No.	cross-section mm <sup>2</sup>	dimensions mm			weight kg/‰/pcs.	crimping-tools/page no.
		d <sub>1</sub>	L	s		
03800	10 f	5	30	1,5	8,30	crimping-tools pages no. 162-200
03801	16 f	6	35	1,5	11,00	
03802	25 f	7,7	40	1,5	15,00	
03803	35 f	9,2	45	1,6	21,80	
03804	50 f	11,2	50	1,8	32,40	
03805	70 f	13,5	60	2	51,00	
03806	95 f	15,5	65	2,25	74,90	
03807	120 f	16,8	65	2,25	84,40	
03808	150 f	19	70	2,5	105,60	
03809	185 f	21	85	2,5	140,10	
03810	240 f	24	100	3	227,30	

**Tubular cable lugs 35f-240f mm<sup>2</sup>  
with narrow flange for fine stranded cables**

Material: Cu-HCP DIN EN 13600  
Surface: tinned

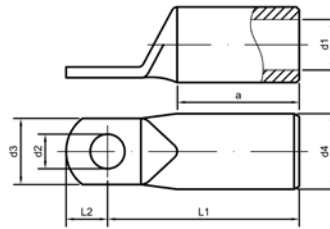

E 485326 up to 240f

Part-No.	cross-section mm <sup>2</sup>	drilling M	dimensions mm						weight kg/‰ pcs.	crimping-tools/page no.	
			d <sub>1</sub>	d <sub>2</sub>	d <sub>3</sub>	d <sub>4</sub>	L <sub>1</sub>	L <sub>2</sub>			a
10850	35f	6	9,2	6,4	15	12,4	35	7,5	18	17,70	12374 page no. 162 30460 page no. 167; 12725 page no. 186 31460 page no. 169
10852	50f	6	11,0	6,4	15	14,8	38,5	7,5	21	26,90	
10853		8		8,4	17		41	10		30,00	
10854		10		10,5	19		45,5	12		33,10	
10855		12		13	19		46,5	13		33,10	
10856	70f	6	13,4	6,4	18	17,5	47,5	7,5	23	45,10	
10857		8		8,4	18		48	10		47,00	
10858		10		10,5	19		50	12		47,40	
10859		12		13	22		51	13		46,30	
10861	95f	6	14,9	6,4	19	20	50	7,5	26	59,50	
10862		8		8,4	19		51	10		62,90	
10863		10		10,5	19		53,5	12		65,40	
10864		12		13	22		55	13		65,50	
10866	120f	6	16,3	6,4	19	21,3	53	7,5	29	68,40	
10867		8		8,4	19		55	10		71,10	
10868		10		10,5	19		57	12		73,40	
10869		12		13	22		58	13		76,30	
10871	150f	6	18,7	6,4	26	24	56	7,5	30	85,70	
10872		8		8,4	26		58	10		91,80	
10873		10		10,5	26		60	12		97,30	
10874		12		13	26		59,5	13		93,90	
10875		16		17	26		62,5	16		105,00	
10876	185f	10	21	10,5	30	26	65	12	35	117,20	
10877		12		13	30		65	13		112,70	
10878		16		17	30		68	16		117,60	
10880	240f	10	23,5	10,5	30	30	76	12	42	185,90	
10881		12		13	30		79	13		200,80	
10882		16		17	30		81	16		202,30	

The dimensions of the cable lugs are coordinated with the dimensions of our fine stranded ropes and silicone insulated leadings. In conjunction with such leadings it is possible to realize connetions also under cramped conditions. Cable lugs with narrow flange for normal stranded cables are described on page 44.

## Tubular cable lugs 35f-240f mm<sup>2</sup> with narrow flange for fine stranded cables

Angle type 90°

Material: Cu-HCP DIN EN 13600

Surface: tinned

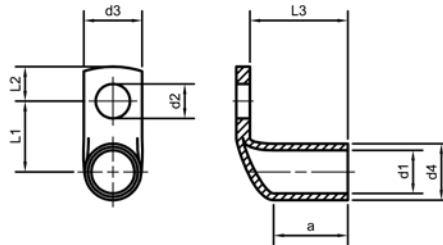

E 485326 up to 240f

Part-No.	cross-section mm <sup>2</sup>	drilling M	dimensions mm								weight kg/‰/pcs.	crimping-tools/page no.
			d <sub>1</sub>	d <sub>2</sub>	d <sub>3</sub>	d <sub>4</sub>	L <sub>1</sub>	L <sub>2</sub>	L <sub>3</sub>	a		
03960	35f	6	9,2	6,4	15	12,4	16,7	7,5	21,5	17	18,00	crimping-tools pages no. 162-200
03961	50f	6	11	6,4	15	14,8	17,9	7,5	24,5	20	26,00	
03962		8		8,4	17		19,9	10			29,00	
03963		10		10,5	19		21,9	12			30,00	
03964	70f	6	13,4	6,4	18	17,5	20	7,5	31	22	43,00	
03965		8		8,4	18		22	10			45,00	
03966		10		10,5	19		24	12			48,00	
03967		12		13	22		27	13			48,00	
03968	95f	6	14,9	6,4	19	20	21	7,5	34	25	64,00	
03969		8		8,4	19		23	10			67,00	
03970		10		10,5	19		25	12			70,00	
03971		12		13	22		26	13			69,00	
03972	120f	6	16,3	6,4	19	21,3	21,7	7,5	37	28	73,00	
03973		8		8,4	19		23,7	10			77,00	
03974		10		10,5	19		25,7	12			79,00	
03975		12		13	22		26,7	13			78,00	
03976	150f	6	18,7	6,4	26	24	23	7,5	37,5	29	92,00	
03977		8		8,4	26		25	10			98,00	
03978		10		10,5	26		27	12			99,60	
03979		12		13	26		28	13			102,00	
03980		16		17	26		31	16			105,00	
03981	185f	10	21	10,5	30	26	28	12	43	34	119,00	
03982		12		13	30		29	13			119,00	
03983		16		17	30		32	16			123,00	
03984	240f	10	23,5	10,5	30	30	30	12	50	41	186,00	
03985		12		13	30		31	13			187,00	
03986		16		17	30		34	16			192,00	

The dimensions of the cable lugs are coordinated with the dimensions of our fine stranded ropes and silicone insulated leadings. In conjunction with such leadings it is possible to realize connetions also under cramped conditions.

### In comparison cable lugs with narrow flange with cable lugs in standard- or Euro-type design

50 mm<sup>2</sup>70 mm<sup>2</sup>95 mm<sup>2</sup>

The use of cable lugs with a narrow flange realize connections and an installation also into smaller places. In combination with our highly flexible silicone insulated leadings according to the following page 40 they offer excellent solutions for high current connections inside of small switch gears or similar application.



**Silicone insulated copper cables 4-300 mm<sup>2</sup> 1,8/3 kV, single insulated**  
highly flexible, free of halogen, self-extinguishing, with UL-Style

- Highest flexibility for high current transfer
- Crimped with our cable lugs with smaller flange acc. to the catalogue pages 38 + 39 well suited for installation works in confined spaces
- With reinforced insulation, mechanically stable and stress resistant
- Free of halogen and self-extinguishing
- Temperature resistant - 50 °C up to + 180 °C shortly up to + 250 °C bis + 300 °C
- Testing voltage 10 kV (Sparktest)
- Dielectric strength 20 kV/mm
- Short circuit resistance SiR + 350° C
- Approvals and fire tests  
UL-Style 3858  
DIN EN 60332-1-2/VDE 0482-332-1-2  
DIN EN 60332-3-24/VDE 0482-332-3-24  
DIN EN 61034-2/VDE 0482-1034-2  
DIN EN 50305/VDE 0260-305 section 9.2
- Delivery: Optionally in rings, on spools or wooden drums

	Part-No.	Technical data								
		Cross-section mm <sup>2</sup>	Dimensions mm			Current load in dependence of the conductor heat in °C				
			Diameter and No. of wires	Outer-Ø ca.	Insulation thickness ca.	45 °C	80 °C	90 °C	100 °C	130 °C
1,5/1,5	15014	4,0	1036 x 0,07	4,8	1,1	30 A	50 A	<b>55 A</b>	60 A	70 A
	15016	6,0	1568 x 0,07	5,6	1,1	40 A	65 A	<b>70 A</b>	78 A	90 A
1,8/3 kV, single insulated	15020	10,0	2562 x 0,07	8,5	2,0	50 A	90 A	<b>98 A</b>	107 A	120 A
	15022	16,0	4116 x 0,07	10,0	2,0	70 A	125 A	<b>132 A</b>	143 A	160 A
	15024	25,0	3234 x 0,10	12,0	2,3	95 A	160 A	<b>176 A</b>	187 A	215 A
	15026	35,0	4508 x 0,10	13,8	2,5	115 A	200 A	<b>218 A</b>	230 A	260 A
	15028	50,0	6468 x 0,10	15,5	2,5	145 A	245 A	<b>276 A</b>	287 A	325 A
	15030	70,0	8967 x 0,10	18,0	2,5	175 A	305 A	<b>347 A</b>	352 A	400 A
	15032	95,0	12201 x 0,10	20,0	2,5	215 A	370 A	<b>416 A</b>	425 A	485 A
	15034	120,0	15435 x 0,10	21,5	2,5	245 A	425 A	<b>488 A</b>	495 A	560 A
	15036	150,0	19404 x 0,10	23,5	2,5	285 A	490 A	<b>566 A</b>	575 A	640 A
	15038	185,0	23580 x 0,10	26,0	2,5	320 A	555 A	<b>644 A</b>	655 A	730 A
	15040	240,0	30600 x 0,10	28,5	2,5	380 A	650 A	<b>775 A</b>	790 A	855 A
	15042	300,0	38200 x 0,10	32,5	2,5	435 A	750 A	<b>898 A</b>	915 A	985 A

**Remark:** All information about current load are approximate values in consideration of the cables heat for single laying of air cooled cables and ambient temperature + 30 °C. The values of a conductor heat of + 90 °C are in accordance with VDE 0298 part 4 table 15. By changing the ambient temperature or the kind of laying reducing factors are to be considered. Nature colour is standard but on request it is also possible to manufacture cables with colours like black, red, blue, yellow/green etc. or with reduced insulation thickness and other operating voltages. Minimum quantity on request. The outside diameter of our highly flexible copper conductors are manufactured in consideration with cable lugs acc. to DIN 46234/DIN 46341 and druseidt tubular cable lugs for fine stranded cables.



# 1. ELECTRICAL CONNECTION- AND INSTALLATION TECHNIQUE

## 1.5 Uninsulated tubular cable lugs and connectors, druseidt EURO-design

Caused by the fact that the German DIN-standardization for cable lugs and connectors cannot cover the whole range of electrical leadings and cables on the market, with their various kinds of conductor constructions and strandings, it is not possible to create an official standard for all designs.

Therefore different designs acc. to the specifications of the cable lug manufacturers have been established on the market. To activate as much as possible customers, druseidt offers, additionally to his approved cable lugs in standard design, a new so called Euro-design with changed tube dimension in the cross-section range of 6-120 mm<sup>2</sup>. So it is possible to cover an additional section of cable lugs circulating in the market. Now customers, owning only tools for connectors acc. to the Euro-design, can buy the cable lugs by our company without making any changes in their tool assortment.

Cable lugs and connectors in Euro-design are deliverable in straight as well as different angled - or designs with narrow flange. We recommend to compress cable lugs in Euro-design with a WM-crimping. Suitable tools and compression die-sets especially for connectors acc. to the Euro-design, are described on the catalogue pages 159 ff.

Please notice, that the crimping procedures will be done only with the right tools in combination with the right compression dies suitable for cable lugs and connectors in Euro-design.

Crimping design:  
WM-crimping



**Tubular cable lugs 0,5-50 mm<sup>2</sup>  
druseidt Euro-Series**

Material: Cu-HCP DIN EN 13600  
Surface: tinned

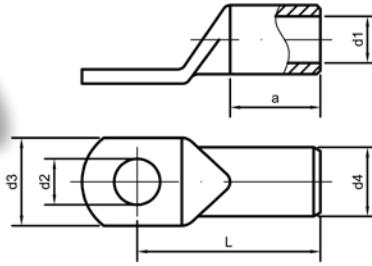

E 485326 from 6 mm<sup>2</sup>

Part-No.		cross-section mm <sup>2</sup>	drilling M	dimensions mm						weight kg/% pcs.	crimping-tools/page no.
without inspection hole	with inspection hole			d <sub>1</sub>	d <sub>2</sub>	d <sub>3</sub>	d <sub>4</sub>	L	a		
01580	-	0,5 - 0,75	3	1,4	3,2	6,5	3	12,5	6	0,71	30446 0,75-10 mm <sup>2</sup> , 30446 1,5-16 mm <sup>2</sup> page no. 160
01581	-		4		4,3	8,5		14		0,80	
01582	-		5		5,3	10		15		1,00	
01583	-	1 - 1,5	3	1,9	3,2	6,5	3,9	14	6	1,20	
01584	-		4		4,3	8,5		15		1,40	
01585	-		5		5,3	10		16		1,50	
01586	-	6		6,4	11		18		1,70		
01588	-	2,5	4	2,4	4,3	8,5	4,4	15	6,5	1,57	
01589	-		5		5,3	10		16		1,72	
01590	-		6		6,4	11		18		1,92	
01591	-	8		8,4	13		20		2,20		
01592	-	4	4	3	4,3	8,5	5	17	8	2,20	
01593	-		5		5,3	10		18		2,40	
01594	-		6		6,4	11		20		2,60	
01595	-	8		8,4	14		22		3,00		
03196	03196/S	6	4	3,5	4,3	10	6,5	19	9	4,60	12372/50, 12372 page no. 161; 12655 page no. 165
03197	03197/S		5		5,3	10		20		4,70	
03198	03198/S		6		6,4	11		21,5		5,40	
03199	03199/S	8		8,4	15		24		5,90		
03200	03200/S	10		10,5	18		26		6,40		
03201	03201/S	12		13	19		27,5		6,40		
03202	03202/S	10	4	4,5	4,3	12	7	20	10	4,30	
03203	03203/S		5		5,3	12		21		4,90	
03204	03204/S		6		6,4	12		22,5		5,10	
03205	03205/S	8		8,4	15		25		5,80		
03206	03206/S	10		10,5	18		27		6,30		
03207	03207/S	12		13	20		28,5		6,30		
03208	03208/S	16	4	5,5	4,3	12	8,5	24	13	8,20	
03209	03209/S		5		5,3	12		25		8,80	
03210	03210/S		6		6,4	12		26,5		9,60	
03211	03211/S	8		8,4	15		29		10,30		
03212	03212/S	10		10,5	18		31		11,00		
03213	03213/S	12		13	19		32		10,80		
03214	03214/S	25	5	7	5,3	15	10	33,5	15	13,50	
03215	03215/S		6		6,4	15		31,5		13,10	
03216	03216/S		8		8,4	16		33		12,90	
03217	03217/S	10		10,5	18		34,5		14,60		
03218	03218/S	12		13	20		36		15,50		
03219	03219/S	14		15	22		39		16,60		
03220	03220/S	16		17	24		42		16,00		
03221	03221/S	35	6	8,5	6,4	17	12	33	17	20,70	
03222	03222/S		8		8,4	17		34		21,80	
03223	03223/S		10		10,5	20		36,5		21,90	
03224	03224/S	12		13	22		37,5		23,30		
03225	03225/S	14		15	23		40		24,40		
03226	03226/S	16		17	28		44		26,00		
03227	03227/S	50	6	10	6,4	20	14	37	19	30,10	
03228	03228/S		8		8,4	20		39		30,40	
03229	03229/S		10		10,5	20		40,5		31,30	
03230	03230/S	12		13	23		42		31,30		
03231	03231/S	14		15	23		44		35,10		
03232	03232/S	16		17	27		46		35,50		
03233	03233/S	20		21	30,5		52,5		38,90		

The dimensions of the Euro-series and the druseidt standard design according to catalogue page 30 are in the cross section range of 0,5-4 mm<sup>2</sup> identically constructed.

Tubular cable lugs 70-630 mm<sup>2</sup>

## druseidt Euro-Series

Material: Cu-HCP DIN EN 13600

Surface: tinned

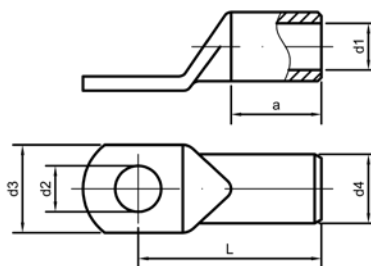
E 485326 up to 500 mm<sup>2</sup>

Part-No.		cross-section mm <sup>2</sup>	drilling M	dimensions mm						weight kg/% pcs.	crimping-tools/page no.		
without inspection hole	with inspection hole			d1	d2	d3	d4	L	a				
03234	03234/S	70	6	12	6,4	24	16,5	40,5	21	41,10	05256 page no. 199	12373 page no. 161; 30460 page no. 167; 12725 page no. 186 31460 page no. 169; 12930, 12933 page no. 171; 12728 page no. 188; 12869 page no. 162 12766 page no. 172; 12965/S, 12968 page no. 173; 14240/41 page no. 177; 12748 page no. 179; 13552 page no. 181; 13551/25, 13551/42, 13537 page no. 183; 12836, 12485-87 page no. 199; 12837 page no. 200; 12724 page no. 190	
03235	03235/S		8		8,4	24			42,5				44,60
03236	03236/S		10		10,5	24			43,5				46,40
03237	03237/S		12		13	24			45				46,40
03238	03238/S		14		15	25			46				49,10
03239	03239/S		16		17	28			48,5				49,60
03240	03240/S		20		21	29			52				51,80
03241	03241/S	95	6	13,5	6,4	26	18	43	23	49,50			
03242	03242/S		8		8,4	26			46				53,60
03243	03243/S		10		10,5	26			47				55,10
03244	03244/S		12		13	26			48				53,50
03245	03245/S		14		15	26			51,5				58,90
03246	03246/S		16		17	28			51				59,70
03247	03247/S		20		21	30			55				61,30
03248	03248/S	120	8	15	8,4	29	20	49,5	26	68,80			
03249	03249/S		10		10,5	29			52				74,20
03250	03250/S		12		13	29			51,5				78,40
03251	03251/S		14		15	30			53				79,90
03252	03252/S		16		17	30			55				80,70
03253	03253/S		20		21	35			60				89,00
03254	03254/S		150	8	16,8	8,4	31	21,3	55,5	29			78,90
01634	01714	10			10,5	31			56,5				81,90
01635	01715	12			13	31			56				80,70
10149	10174	14			15	31			57				80,00
01636	01716	16			17	31			58				83,60
01637	01717	20			21	35			63				87,50
10145	10175	185		10	19	10,5	35	24	59	30			106,10
01638	01718		12		13	35			58,5				106,00
10151	10176		14		15	35			61		107,20		
01639	01719		16		17	35			63		108,60		
01640	01720		20		21	35			66		113,30		
10152	10177		240	10	21	10,5	38	26	67	35	129,70		
01641	01721			12		13	38			67		130,20	
10153	10178	14			15	38			69		133,60		
01642	01722	16			17	38			69,5		138,40		
01643	01723	20			21	38			71		138,00		
01644	01724	300		12	24	13	44	30	82	42	217,20		
10154	10190			14		15	44			84		221,90	
01645	01725		16		17	44			85		219,40		
01646	01726		20		21	44			85		229,20		
10155	-		400	10	27,5	10,5	49	33,5	92	47	279,00		
10150	-			12		13	49			92		279,00	
01647	-			16		17	49			92		279,00	
01648	-	20			21	49			92		281,90		
01649	-	500	16	31	17	55,5	38	113	70	493,80			
01650	-		20		21	55,5			113		485,60		
01651	-	630	16	34	17	60	41	115	70	513,50			
01652	-		20		21	60			115		506,00		

The dimensions of the Euro-Series and the druseidt standard design according to catalogue page 31 are in the cross section range of 150-630 mm<sup>2</sup> identically constructed.



## Tubular cable lugs 35-300 mm<sup>2</sup> with narrow flange druseidt Euro-Series

Material: Cu-HCP DIN EN 13600

Surface: tinned

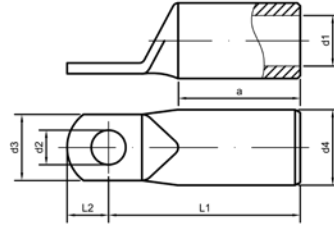

E 485326

Part-No.	cross-section mm <sup>2</sup>	drilling M	dimensions mm							weight kg/‰ pcs.	crimping-tools/page no.
			d <sub>1</sub>	d <sub>2</sub>	d <sub>3</sub>	d <sub>4</sub>	L <sub>1</sub>	L <sub>2</sub>	a		
03900	35	6	8,5	6,4	15	12	33	7,5	17	18,00	1237250.pno.161 12655.pno.165 12372 page no. 161 12373 page no. 161; 30460 page no. 167; 12725 page no. 186 31460 page no. 169; 12930, 12933 page no. 171; 12728 page no. 188; 12869 page no. 162 12766 page no. 172; 12965/S, 12968 page no. 173; 14240/41 page no. 177; 12748 page no. 179; 13552 page no. 181; 13551/25, 13551/42, 13537 page no. 183; 12836, 12485-87, 05256 page no. 199; 12837 page no. 200; 12724 page no. 190
03901		8		8,4	15		35	10		21,60	
03902	50	6	10	6,4	15	14	37	7,5	19	27,30	
03903		8		8,4	17		39	10		28,30	
03904		10		10,5	17		41	12		29,90	
03905	70	6	11,8	6,4	17	16,5	41	7,5	21	40,60	
03906		8		8,4	17		43	10		43,00	
03907		10		10,5	17		45	12		44,00	
03908		12		13	19		46	13		44,80	
03909	95	6	13,5	6,4	19	18	43	7,5	23	46,70	
03910		8		8,4	19		45	10		49,00	
03911		10		10,5	19		47	12		51,00	
03912		12		13	19		48	13		52,00	
03913	120	6	14,7	6,4	20	20	49	7,5	26	64,30	
03914		8		8,4	20		51	10		67,30	
03915		10		10,5	20		53	12		67,00	
03916		12		13	20		54	13		73,40	
03917	150	6	16,3	6,4	19	21,3	53	7,5	29	70,10	
03918		8		8,4	19		55	10		73,10	
03919		10		10,5	19		56	12		76,30	
03920		12		13	22		59	13		76,30	
03921	185	10	18,7	10,5	26	24	60	12	30	104,70	
03922		12		13	26		59,5	13		103,60	
03923		16		17	26		64	16		111,40	
03924	240	10	21	10,5	30	26	65	12	35	119,50	
03925		12		13	30		65	13		121,90	
03926		16		17	30		68	16		122,60	
03927	300	10	23,5	10,5	30	30	76	12	42	196,60	
03928		12		13	30		79	13		200,80	
03929		16		17	30		81	16		206,00	

Designs with inspection hole or 90° angled on request.

Tubular cable lugs 0,5-35 mm<sup>2</sup>

Angle type 90°

druseidt Euro-Series

Material: Cu-HCP DIN EN 13600

Surface: tinned

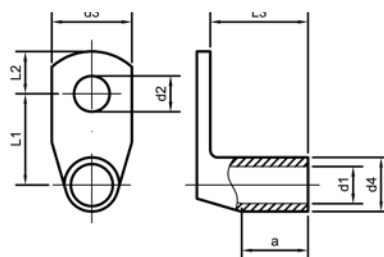
E 485326 from 6 mm<sup>2</sup>

Part-No.	cross-section mm <sup>2</sup>	drilling M	dimensions mm									weight kg/‰ pcs.	crimping-tools/page no.
			d <sub>1</sub>	d <sub>2</sub>	d <sub>3</sub>	d <sub>4</sub>	L <sub>1</sub>	L <sub>2</sub>	L <sub>3</sub>	a			
10400	0,5-0,75	3	1,4	3,2	6,5	3	7,5	4	9,5	5	0,90	30445 0,75-10 mm <sup>2</sup> , 30446 1,5-16 mm <sup>2</sup> page no. 160  12372/50, 12372 page no. 161; 12655 page no. 165	
10402		4		4,3	8,5		8,5	5			1,00		
10404		5		5,3	10		9,5	5,5			1,00		
10406	1-1,5	3	1,9	3,2	6,5	3,9	8	4	9,5	5	1,60		
10408		4		4,3	8,5		9	5			1,60		
10410		5		5,3	10		10	5,5			1,60		
10412		6		6,4	11		12	7,5			1,60		
10414	2,5	4	2,4	4,3	8,5	4,4	9,2	5	9,5	5,5	1,83		
10416		5		5,3	10		10,2	5,5			1,84		
10418		6		6,4	11		12,2	7,5			2,20		
10420		8		8,4	14		14,2	10			2,30		
10422	4	4	3	4,3	8,5	5	9,5	5	10,5	7	2,50		
10424		5		5,3	10		10,5	5,5			2,41		
10426		6		6,4	11		12,5	7,5			2,90		
10428		8		8,4	14		14,5	10			3,00		
03815	6	4	3,5	4,3	10	6,5	10,3	5	13,5	8	6,00		
03816		5		5,3	11		11,2	5,5			5,60		
03817		6		6,4	11		13,3	7,5			6,20		
03818		8		8,4	15		15,3	10			6,40		
03819		10		10,5	18		17,2	12			6,80		
03820		12		13	20		18,2	13			6,60		
03821	10	5	4,5	5,3	12	7	11,5	5,5	15	9	5,40		
03822		6		6,4	12		12,5	7,5			5,90		
03823		8		8,4	15		15,5	10			6,70		
03824		10		10,5	18		17,5	12			7,00		
03825		12		13	20		18,5	13			7,00		
03826	16	5	5,5	5,3	12	8,5	13	5,5	21	12	10,70		
03827		6		6,4	12		14,3	7,5			11,50		
03828		8		8,4	15		16,3	10			12,00		
03829		10		10,5	18		18,3	12			12,30		
03830		12		13	20		19,3	13			12,30		
03831	25	6	7	6,4	15	10	15,5	7,5	18	14	13,50		
03832		8		8,4	16		17,5	10			14,30		
03833		10		10,5	18		19,5	12			16,80		
03834		12		13	20		20,5	13			15,10		
03835		14		15	22		22,5	15			16,90		
03836	35	6	8,5	6,4	17	12	16,5	7,5	19,5	16	21,00		
03837		8		8,4	17		18,5	10			23,10		
03838		10		10,5	20		20,5	12			23,60		
03839		12		13	22		21,5	13			23,70		
03840		14		15	23		23,5	15			24,80		
03841		16		17	28		24,5	16			24,80		

The dimensions of the Euro-Series and the druseidt standard design according to catalogue page 32 are in the cross section range of 0,5-4 mm<sup>2</sup> identically constructed.

**Tubular cable lugs 50-300 mm<sup>2</sup>**
**Angle type 90°**
**druseidt Euro-Series**

Material: Cu-HCP DIN EN 13600

Surface: tinned

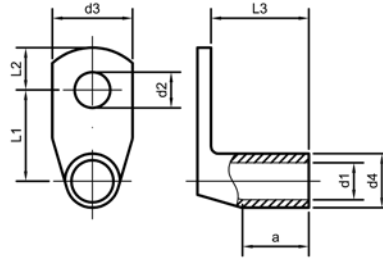

E 485326

Part-No.	cross-section mm <sup>2</sup>	drilling M	dimensions mm								weight kg/% pcs.	crimping-tools/page no.
			d <sub>1</sub>	d <sub>2</sub>	d <sub>3</sub>	d <sub>4</sub>	L <sub>1</sub>	L <sub>2</sub>	L <sub>3</sub>	a		
03842	50	6	10	6,4	20	14	17,5	7,5	21,5	18	30,00	12869 page no. 162
03843		8		8,4	20		19,5	10			32,20	
03844		10		10,5	20		21,5	12			33,20	
03845		12		13	23		22,5	13			32,80	
03846		14		15	23		24,5	15			33,70	
03847		16		17	27		28,5	16			36,30	
03848		20		21	30		32,5	19			38,90	
03849	70	6	12	6,4	24	16,5	18,8	7,5	26	20	44,10	
03850		8		8,4	24		20,8	10			49,20	
03851		10		10,5	24		22,8	12			50,60	
03852		12		13	24		23,8	13			48,70	
03853		14		15	25		25,8	15			48,40	
03854		16		17	28		26,8	16			51,10	
03855		20		21	29		30,8	19			52,60	
03856	95	8	13,5	8,4	26	18	21,5	10	26,4	22	53,30	
03857		10		10,5	26		23,5	12			55,90	
03858		12		13	26		24,5	13			55,30	
03859		14		15	26		26,5	15			58,90	
03860		16		17	28		27,5	16			60,00	
03861	120	8	15	8,4	29	20	22,5	10	32	25	76,30	
03862		10		10,5	29		24,5	12			80,70	
03863		12		13	29		25,5	13			80,10	
03864		16		17	30		28,5	16			84,60	
03865	150	8	16,8	8,4	31	21,3	25,7	10	34	28	80,30	
03866		10		10,5	31		25,7	12			80,70	
03867		12		13	31		26,7	13			82,90	
03868		16		17	31		29,7	16			85,00	
03869		20		21	35		33,7	19			88,90	
03870	185	10	19	10,5	35	24	27	12	42	29	114,10	
03871		12		13	35		28	13			120,40	
03872		16		17	35		31	16			124,80	
03873		20		21	35		35	19			127,00	
03874	240	10	21	10,5	38	26	28	12	44	34	133,20	
03875		12		13	38		29	13			132,80	
03876		16		17	38		32	16			137,80	
03877		20		21	38		36	19			141,50	
01838	300	12	24	13	43	30	31	13	51	41	199,20	
01840		16		17	43		34	16			209,00	
01842		20		21	43		38	19			218,10	

 The dimensions of the Euro-Series and the druseidt standard design according to catalogue page 33 are in the cross section range of 300 mm<sup>2</sup> identically constructed.

Tubular cable lugs 10-300 mm<sup>2</sup>

## Angle type 45°

## druseidt Euro-Series

Material: Cu-HCP DIN EN 13600

Surface: tinned

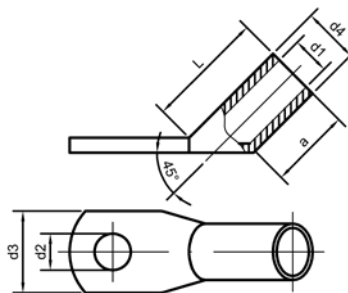

Part-No.	cross-section mm <sup>2</sup>	drilling M	dimensions mm				L	a	weight kg/‰ pcs.	crimping-tools/page no.	
			d <sub>1</sub>	d <sub>2</sub>	d <sub>3</sub>	d <sub>4</sub>					
03821/S-45	10	5	4,5	5,3	12	7	13,5	9	5,50	12766	30446
03822/S-45		6		6,4	12		13,5		5,80	13551/25	30446
03823/S-45		8		8,4	15		13,8		6,50	12372	30446
03824/S-45		10		10,5	18		13,8		6,60	12372/50	30446
03826/S-45	16	5	5,5	5,3	12	8,5	17,5	12	9,50	12373	12655
03827/S-45		6		6,4	12		17,5		10,20	12373	12655
03828/S-45		8		8,4	15		17,7		11,70	12373	12655
03829/S-45		10		10,5	18		18		11,70	12373	12655
03831/S-45	25	6	7	6,4	15	10	20,7	14	13,90	12373	12655
03832/S-45		8		8,4	16		20,9		15,10	12373	12655
03833/S-45		10		10,5	18		21,1		16,60	12373	12655
03834/S-45		12		13	20		21,2		17,00	12373	12655
03836/S-45	35	6	8,5	6,4	17	12	24,2	16	21,70	12373	12655
03837/S-45		8		8,4	17		24,2		22,30	12373	12655
03838/S-45		10		10,5	20		24,5		23,40	12373	12655
03839/S-45		12		13	22		24,7		24,00	12373	12655
03842/S-45	50	6	10	6,4	20	14	27,7	18	29,40	12373	12655
03843/S-45		8		8,4	20		27,7		33,40	12373	12655
03844/S-45		10		10,5	20		27,7		36,50	12373	12655
03845/S-45		12		13	23		28,1		36,50	12373	12655
03850/S-45	70	8	12	8,4	24	16,5	31,9	20	49,00	12373	12655
03851/S-45		10		10,5	24		33		52,30	12373	12655
03852/S-45		12		13	24		31,9		51,70	12373	12655
03856/S-45	95	8	13,5	8,4	26	18	35,5	22	63,20	12373	12655
03857/S-45		10		10,5	26		35		62,00	12373	12655
03858/S-45		12		13	26		35,5		62,00	12373	12655
03859/S-45		16		17	28		35,5		68,00	12373	12655
03861/S-45	120	8	15	8,4	29	20	40,1	25	78,00	12373	12655
03862/S-45		10		10,5	29		40,1		89,00	12373	12655
03863/S-45		12		13	29		40,1		89,10	12373	12655
03864/S-45		16		17	30		40,2		93,10	12373	12655
03865/S-45	150	8	16,8	8,4	31	21,3	47,5	28	102,00	12373	12655
03866/S-45		10		10,5	31		47,5		98,00	12373	12655
03867/S-45		12		13	31		47,5		96,80	12373	12655
03868/S-45		16		17	31		47,5		101,20	12373	12655
03869/S-45		20		21	35		48,2		101,20	12373	12655
01831/S-45	185	12	19	13	35	24	51	29	122,90	12373	12655
01832/S-45		16		17	35		51		119,60	12373	12655
01833/S-45		20		21	35		51		139,90	12373	12655
01834/S-45	240	12	21	13	38	26	61	34	154,60	12373	12655
01835/S-45		16		17	38		61		165,10	12373	12655
01836/S-45		20		21	38		61		170,40	12373	12655
03880/S-45	300	16	24	17	43	30	69	41	256,80	12373	12655
03881/S-45		20		21	43				273,00	12373	12655

The dimensions of the Euro-Series and the druseidt standard design according to catalogue page 33 are in the cross section range of 185 and 240 mm<sup>2</sup> identically constructed.



**Butt connectors**

**druseidt Euro-Series**

Material: Cu-HCP or ETP DIN EN 13600

Surface: tinned

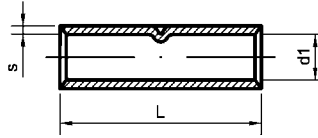

E 485326 from 6 up to 400 mm<sup>2</sup>

Part-No.	cross-section mm <sup>2</sup>	dimensions mm			weight kg/‰ pcs.	crimping-tools/page no.
		d <sub>1</sub>	L	s		
13686	0,5-0,75	1,4	15	0,8	0,80	pages no. 160-162 165-200
13687	1-1,5	1,9	15	1	1,20	
13688	2,5	2,4	16	1	1,50	
13689	4	3	19	1	2,10	
03165	6	3,5	25	1,5	5,10	
03166	10	4,5	30	1,25	6,00	
03167	16	5,5	35	1,5	10,00	
03168	25	7	40	1,5	14,10	
03169	35	8,5	45	1,75	21,60	
03170	50	10	50	2	33,20	
03171	70	12	55	2,25	49,10	
03172	95	13,5	60	2,25	60,90	
03173	120	15	65	2,5	78,80	
13699	150	16,8	70	2,25	86,50	
01752	185	19	75	2,5	116,25	
01753	240	21	85	2,5	142,20	
01754	300	24	100	3	224,00	
01755	400	27,5	100	3	261,70	
01756	500	31	140	3,5	473,00	
01757	630	34	160	3,5	617,50	

The dimensions of the Euro-Series and the druseidt standard design according to catalogue page 34 are in the cross section range of 0,5 -4 mm<sup>2</sup> and 150-630 mm<sup>2</sup> identically constructed.

**Tubular T-connectors 1-300 mm<sup>2</sup>**

**druseidt Euro-Series**

Material: Cu-HCP or ETP DIN EN 13600

Surface: tinned

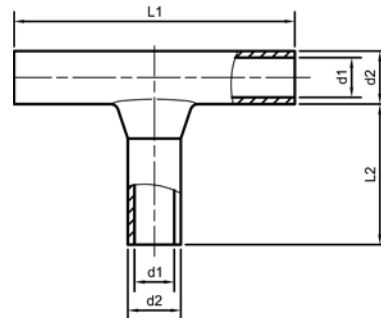

E 485326 from 6 mm<sup>2</sup>

Part-No.	cross-section mm <sup>2</sup>	dimensions mm				weight kg/‰ pcs.	crimping-tools/page no.
		d <sub>1</sub>	d <sub>2</sub>	L <sub>1</sub>	L <sub>2</sub>		
03941	1-1,5	1,9	3,9	30	6	3,60	30445 up to 10 mm <sup>2</sup> page no. 160 30446 up to 16 mm <sup>2</sup> page no. 160 12373/50 page no. 161; 12655 page no. 165 12372 page no. 161 12373 p.no. 161; 30460 p.no. 169; 12725 p.no. 186 12930, 12933 page no. 171; 12728 page no. 188 14240/42 page no. 177; 12748 page no. 179
03942	2,5	2,4	4,4	30	16	4,50	
03943	4	3	5	35	16,5	5,70	
03944	6	3,5	6,5	35	17	10,80	
03945	10	4,5	7	45	25	14,00	
03946	16	5,5	8,5	50	26	23,00	
03947	25	7	10	50	27	24,00	
03948	35	8,5	12	60	31	45,00	
03949	50	10	14	72	35	72,00	
03950	70	12	16,5	77	37	103,50	
03951	95	13,5	18	88	45	127,00	
03952	120	15	20	106	53	178,00	
03953	150	16,8	21,3	120	58	234,20	
03954	185	19	24	110	42	256,20	
03955	240	21	26	135	55	339,40	
03956	300	24	30	140	55	477,00	

# 1. ELECTRICAL CONNECTION- AND INSTALLATION TECHNIQUE

## 1.6 Tubular compression lugs and connectors as well as reduction sleeves and H-shaped connectors

Such tubular cable lugs and connectors out of copper are manufactured acc. to DIN 46235 and DIN 46267 part 1. We deliver a tin-plated as well as an uncoated design. Basically all terminals are applicable for crimping stranded or fine stranded conductors. Caused by the relative long designed connecting sleeve they are often used for crimping stranded copper conductors acc. to DIN 48201 part 1 or similar.

All cable lugs and connectors are equipped with a graven code number and lines, which shows the necessary numbers of crimping procedures. The right crimping design is a hexagonal crimping executed with suitable tools which dies have the same code-number like the cable connectors. To realize a crimping of conductors with a different cross-section range we deliver reduction sleeves, which can be used for non tension connections. To realize a branch off conductors with the same cross-section range of 70-120 mm<sup>2</sup> we deliver H-shaped connecting clamps and on request C-shaped branch off clamps too.

Please notice, that the crimping procedure will be done only with the right tools in combination with the right compression dies suitable for the described tubular compression connectors.

Crimping design:  
Hexagonal-crimping

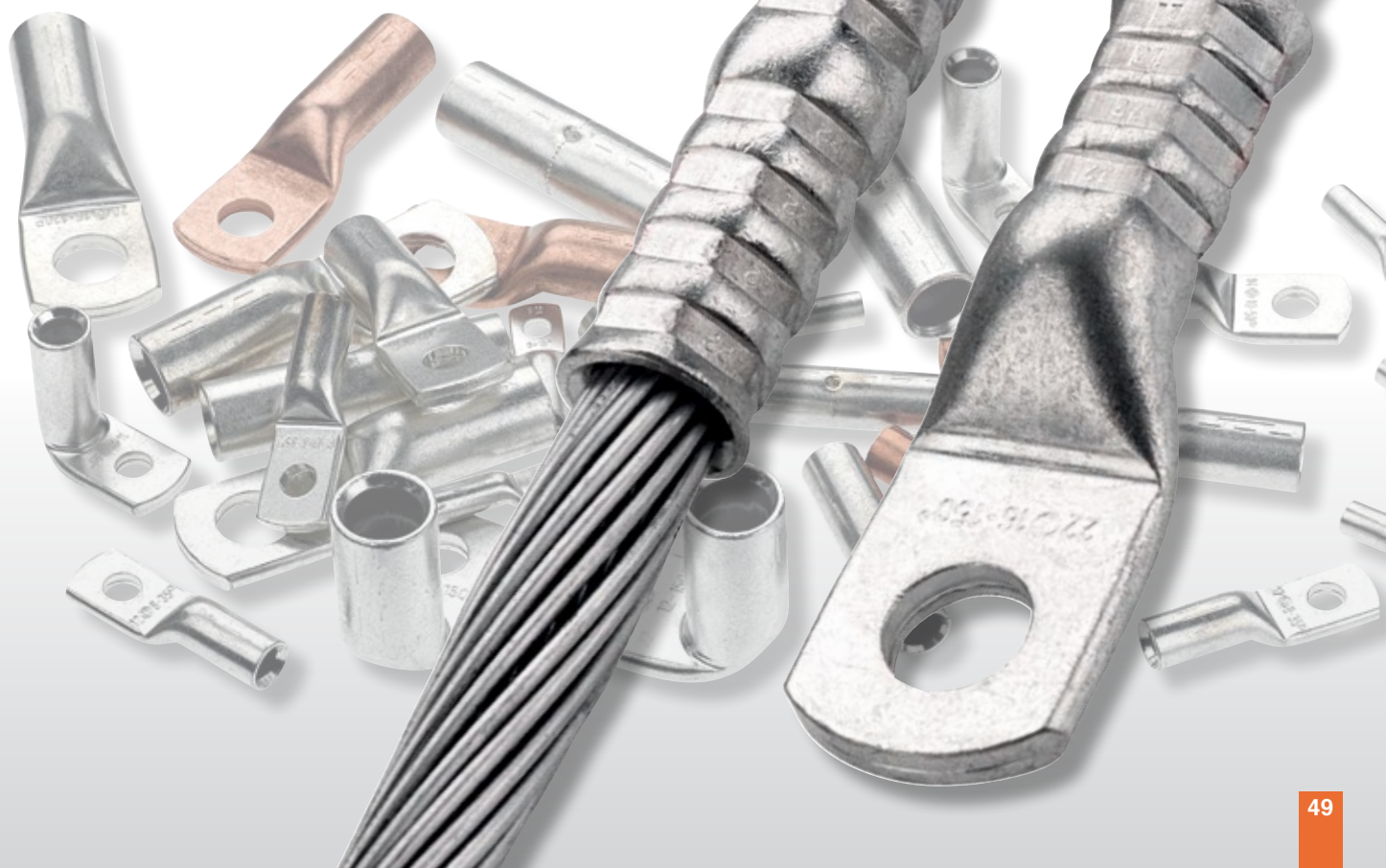

**Tubular cable lugs 6-240 mm<sup>2</sup>  
DIN 46235 and special design**

Material: Cu-HCP DIN EN 13600

Surface: tinned or uncoated

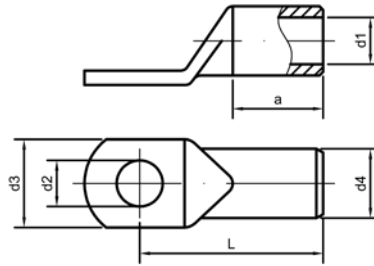
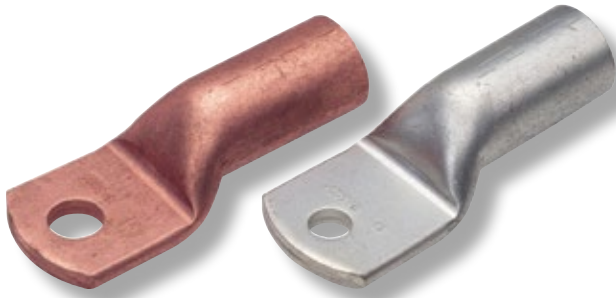

Part-No.		cross-section mm <sup>2</sup>	drilling M	index-no.	dimensions mm						weight kg/% pcs.	crimping-tools/page no.				
tinned	uncoated				d <sub>1</sub>	d <sub>2</sub>	d <sub>3</sub>	d <sub>4</sub>	L	a						
01917	01917 bl	6	5	5	3,7	5,3	8,5	5,5	24	10	3,10	12766 page no. 172; 12740/41 page no. 177; 13552 page no. 181; 12836 page no. 199; 12869 page no. 162; 12724 page no. 190	12370/50 page no. 162; 12655 page no. 165			
01918	01918 bl		6		6,4	9	24	3,40								
10300	10300 bl		8		8,4	13	26	3,50								
01919	01919 bl	10	5	6	4,4	5,3	10	6	27	10	3,50			12371 page no. 162; 30460 page no. 168; 12725 page no. 186	31460 page no. 169; 12930, 12933 page no. 171; 12965/S, 12968 page no. 173; 12748 page no. 179; 13551/25, 13551/42, 13537 page no. 183; 12728 page no. 188 (up to 185 mm <sup>2</sup> ); 12485-87, 12837, 05256 page no. 199	
01920	01920 bl		6		6,4	10	27	3,70								
01921	01921 bl		8		8,4	13	28	3,80								
10302	10302 bl		10		10,5	15	29	3,80								
10304	10304 bl	16	5	8	5,5	5,3	13	8,5	36	20	12,20					05256 page no. 199
01922	01922 bl		6		6,4	13	36	12,70								
01923	01923 bl		8		8,4	13	37	13,00								
01924	01924 bl		10		10,5	16,5	38	13,40								
01925	01925 bl		12		13	19	40	13,60								
01926	01926 bl		25		6	10	7	6,4	14	10	39	20	16,20			
01927	01927 bl	8		8,4	17		39	17,30								
01928	01928 bl	10		10,5	17		40,5	17,70								
01929	01929 bl	12		13	18		40,5	17,30								
10306	10306 bl	35	6	12	8,2	6,4	17,5	12,5	42,5	20	31,60	12370/50 page no. 162; 12655 page no. 165				
01930	01930 bl		8		8,4	18	42	31,90								
01931	01931 bl		10		10,5	20	42,5	31,20								
01932	01932 bl		12		13	21	44	31,70								
10308	10308 bl		16		17	28	47	31,40								
10310	10310 bl		50		6	14	9,8	6,4	20	14,5	52		28	45,90		
01933	01933 bl				8		8,4	20	52	49,50						
01934	01934 bl	10		10,5	22		52	48,10								
01935	01935 bl	12		13	24		52	47,20								
01936	01936 bl	16		17	28		55,5	50,00								
13285	13285 bl	70		8	16		11,3	8,4	24	16,5	56		28	65,40		
01937	01937 bl		10	10,5		24	56	65,90								
01938	01938 bl		12	13		24	56,5	60,10								
01939	01939 bl		16	17		29	57	64,10								
10312	10312 bl		95	8		18	13,5	8,4	28	19	65	35	93,60			
01940	01940 bl	10		10,5	28		65,5	95,50								
01941	01941 bl	12		13	28		65,5	94,50								
01942	01942 bl	16		17	30		65,5	94,40								
10314	10314 bl	20		21	33		71	98,60								
10316	10316 bl	120		8	20		15,5	8,4	31	21	70	35	113,50			
13286	13286 bl			10			10,5	31	70	114,00						
01943	01943 bl			12			13	31	70,5	114,70						
01944	01944 bl		16	17		31,5	70	111,50								
01945	01945 bl		20	21		36	72	115,10								
13287	13287 bl	150	10	22	17	10,5	34	23,5	79	35	164,10					
01946	01946 bl		12		13	34	78,5	165,30								
01947	01947 bl		16		17	34	78	163,50								
01948	01948 bl		20		21	38	78	159,80								
13288	13288 bl		185		10	25	19	10,5	37	25,5	83	40	185,00			
01949	01949 bl				12		13	37	82,5	189,60						
01950	01950 bl	16		17	37		82	187,80								
01951	01951 bl	20		21	40		83	189,00								
10318	10318 bl	240		10	28		21,5	10,5	42	29	92	40	271,00			
01952	01952 bl		12	13		42,5	92	266,50								
01953	01953 bl		16	17		42,5	92	274,50								
01954	01954 bl		20	21		45	92	268,00								

The tin plated design is standard in our stock.

## Tubular cable lugs 300-1000 mm<sup>2</sup>

### DIN 46235 and special design

Material: Cu-HCP DIN EN 13600

Surface: tinned or uncoated

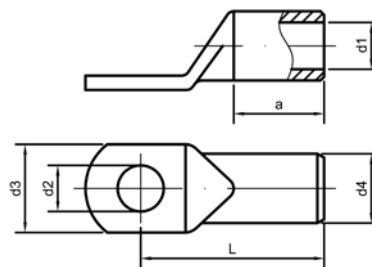
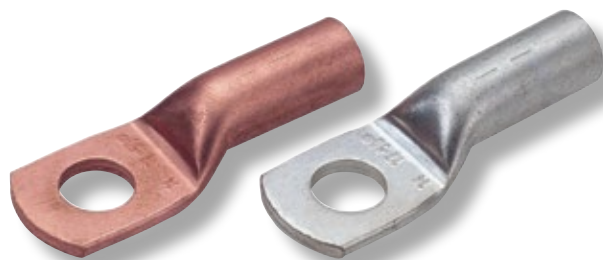

Part-No.		cross-section mm <sup>2</sup>	drilling M	index-no.	dimensions mm						weight kg/% pcs.	crimping-tools/page no.		
tinned	uncoated				d <sub>1</sub>	d <sub>2</sub>	d <sub>3</sub>	d <sub>4</sub>	L	a				
10320	10320 bl	300	12	32	24,5	13	48,5	32	104	50	336,50	pages no. 172-199		
01955	01955 bl		16			17							100	337,20
01956	01956 bl		20			21							100	344,60
01957	01957 bl	400	12	38	27,5	13	55	38,5	117	70	717,00			
01958	01958 bl		16			17							117	702,80
01959	01959 bl		20			21							117	706,00
01960	01960 bl	500	12	42	31	13	60	42	130	70	869,20			
01961	01961 bl		16			17							130	892,70
01962	01962 bl		20			21							130	881,40
01963	01963 bl	625	20	44	34,5	21	63	44	135	80	820,50			
02002	02002 bl		16			17						165	1430,00	
02004	02004 bl		20			21						165	1455,50	
02006	02006 bl	1000	20	58	44	21	83	58	167	100	1890,00			

The tin plated design is standard in our stock.

## Cable lugs 10-150 mm<sup>2</sup>

### hooked design, longitudinally sealed

Material: Cu-ETP DIN EN 13601

Surface: tinned or uncoated

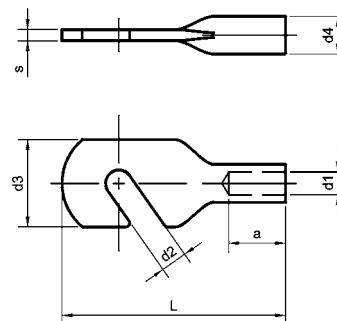
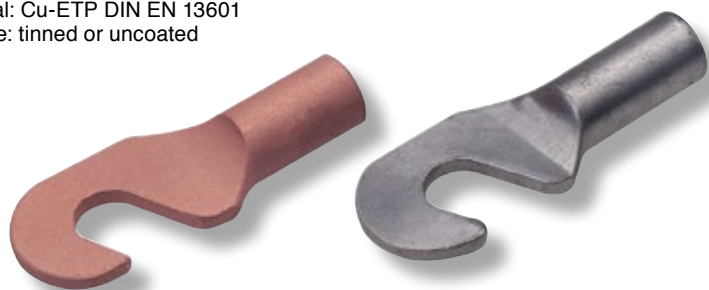

Part-No.		cross-section mm <sup>2</sup>	drilling M	dimensions mm						weight kg/% pcs.	crimping-tools/page no.	
uncoated	tinned			d <sub>1</sub>	d <sub>2</sub>	d <sub>3</sub>	d <sub>4</sub>	L	a			s
10210	10210 vz	10	6	5	7	22	10	55	15	3	3,90	on request
10211	10211 vz	16	8	6	9	22,5	10	60	15	3	4,20	
10212	10212 vz	25	8	8	9	25	12	60	15	3	6,10	
10213	10213 vz		10		11			65			6,60	
10212/35	10212/35 vz	35	8	9	9	25	12	60	15	3	6,10	
10213/35	10213/35 vz											
10214	10214 vz	50	10	11	11	30	15	70	20	3	11,00	
10215	10215 vz											
10216	10216 vz	70	10	13	11	35	18	80	22	4	18,10	
10217	10217 vz											
10218	10218 vz	95	12	15	13	40	20	90	25	5	25,20	
10219	10219 vz											
10220	10220 vz	120	12	17	13	40	25	100	25	7	43,70	
10221	10221 vz											
10222	10222 vz	150	12	19	13	40	25	100	25	7	43,70	
10223	10223 vz											

This cable lugs in hooked design offer a quick and safe connecting of our binding posts acc. to catalogue pages 116 and 117, 10210 for 63 A, 10211/10212/10213/35 for 100 A, 10217/10218 for 200 A and 10221/10223 for 400 A.



### Tubular cable lugs 10-300 mm<sup>2</sup>

#### Angle type 90°

Dimensions of the tube in acc. with DIN 46235

Material: Cu-HCP DIN EN 13600

Surface: tinned or uncoated

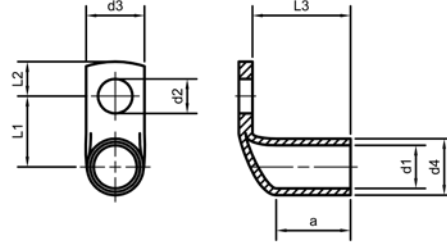
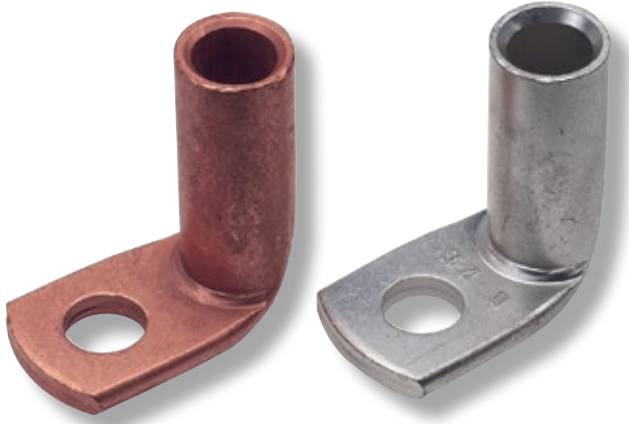

Part-No.		cross-section mm <sup>2</sup>	drilling M	index-no.	dimensions mm								weight kg/‰ pcs.	crimping-tools/page no.
tinned	uncoated				d <sub>1</sub>	d <sub>2</sub>	d <sub>3</sub>	d <sub>4</sub>	L <sub>1</sub>	L <sub>2</sub>	L <sub>3</sub>	a		
13124	13124 bl	10	6	6	4,4	6,4	10	6	13	7,7	14	10	3,50	12766 page no. 172; 12965/S, 12968; page no. 173; 14240/41 page no. 177; 12748 page no. 179; 13552 page no. 181; 13551/25, 13551/42, 13537 page no. 183; 12836, 12485-87; 05256 page no. 199; 12724 page no. 190; 12837 page no. 200
13126	13126 bl		8			8,4	13		15	10			3,70	
13128	13128 bl	16	6	8	5,5	6,4	13	8,5	14,3	9	23	20	12,70	
13130	13130 bl		8			8,4	13		16,3	11,5	23		13,00	
13132	13132 bl		10			10,5	16,5		18,3	13,5	24		14,10	
13134	13134 bl		12			13	19		19,3	14,5	24		13,80	
13136	13136 bl	25	6	10	7	6,4	15	10	15,5	9	23,8	20	16,80	
13138	13138 bl		8			8,4	16		17,5	11,5			17,60	
13140	13140 bl		10			10,5	16		19,5	13,5			18,40	
13142	13142 bl		12			13	19		20,5	14,5			17,20	
13143	13143 bl	35	6	12	8,2	6,4	17	12,5	16,8	9	23,8	20	27,40	
13144	13144 bl		8			8,4	17		18,8	11,5			30,40	
13146	13146 bl		10			10,5	19		20,8	13,5			31,20	
13148	13148 bl		12			13	21		21,8	14,5			32,60	
13150	13150 bl	50	8	14	9,8	8,4	20	14,5	19,8	11,5	33	28	46,20	
13152	13152 bl		10			10,5	22		21,8	13,5	32		48,20	
13154	13154 bl		12			13	24		22,8	14,5	32		48,30	
13156	13156 bl		16			17	27		25,8	17,5	32		50,60	
13157	13157 bl	70	8	16	11,3	8,4	24	16,5	20,8	11,5	34	28	59,30	
13158	13158 bl		10			10,5	24		22,8	13,5			65,10	
13160	13160 bl		12			13	24		23,8	14,5			65,60	
13162	13162 bl		16			17	29		26,8	17,5			63,10	
13163	13163 bl	95	8	18	13,5	8,4	28	19	22	10	42	35	85,00	
13164	13164 bl		10			10,5	28		24	13,5			93,70	
13166	13166 bl		12			13	28		25	14,5			94,90	
13168	13168 bl		16			17	32		28	17,5			96,70	
13170	13170 bl	120	10	20	15,5	10,5	32	21	25,5	13,5	42	35	108,40	
13172	13172 bl		12			13	32		32	14,5			110,00	
13174	13174 bl		16			17	32		29,5	17,5			111,60	
13176	13176 bl		20			21	38		33,5	20,5			123,90	
13177	13177 bl	150	10	22	17	10,5	34	23,5	26,8	13,5	42	35	141,60	
13178	13178 bl		12			13	34		27,8	14,5			144,10	
13180	13180 bl		16			17	34		30,8	17,5			148,30	
13182	13182 bl		20			21	34		34,8	20,5			155,10	
13184	13184 bl	185	10	25	19	10,5	37	25,5	27,8	13,5	48	40	168,10	
13186	13186 bl		12			13	37		28,8	14,5			172,90	
13188	13188 bl		16			17	37		31,8	17,5			171,80	
13190	13190 bl		20			21	40		35,8	20,5			202,00	
13192	13192 bl	240	12	28	21,5	13	42	29	30,5	14,5	52	40	226,10	
13194	13194 bl		16			17	42		33,5	17,5			244,60	
13195	13195 bl		20			21	42		37,5	20,5			255,90	
13196	13196 bl	300	12	32	24,5	13	48,5	32	32	14,5	60	50	290,80	
13197	13197 bl		16			17	48,5		35	17,5			305,10	
13198	13198 bl		20			21	48,5		39	20,5			386,00	

**Compression lugs 6-1000 mm<sup>2</sup>****DIN 46267 part 1**

for non tension connections

Material: Cu-HCP DIN EN 13600

Surface: tinned

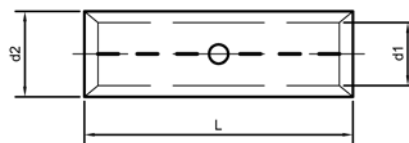

Part-No.	cross-section mm <sup>2</sup>	index-no.	dimensions mm			weight kg/‰ pcs.	crimping-tools/page no.
			d <sub>1</sub>	d <sub>2</sub>	L		
01964	6	5	3,7	5,5	30	3,50	pages no. 162-200
01965	10	6	4,4	6	30	3,50	
01966	16	8	5,5	8,5	50	15,30	
01967	25	10	7	10	50	18,60	
01968	35	12	8,2	12,5	50	32,30	
01969	50	14	9,8	14,5	56	44,90	
01970	70	16	11,3	16,5	56	56,40	
01971	95	18	13,5	19	70	89,80	
01972	120	20	15,5	21	70	102,70	
01973	150	22	17	23,5	80	150,30	
01974	185	25	19	25,5	85	167,80	
01975	240	28	21,5	29	90	232,00	
01976	300	32	24,5	32	100	295,00	
01977	400	38	27,5	38,5	150	767,00	
01978	500	42	31	42	160	920,80	
01979	625	44	34,5	44	160	868,20	
01988	800	52	40	52	200	1525,00	
01999	1000	58	44	58	200	1970,00	

**Compression connectors in H-shaped design**

for copper conductors acc. to DIN 48201

Material: Cu-ETP DIN EN 13601

Surface: tinned or uncoated

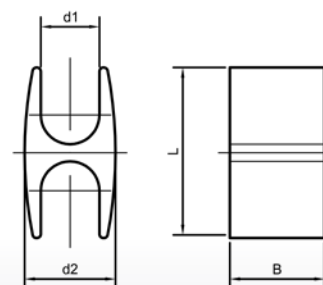
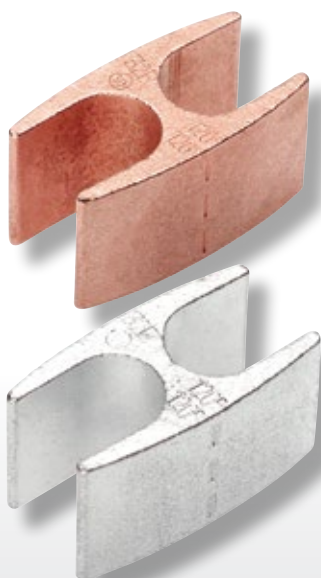

Part-No.		cross-section mm <sup>2</sup>		dimensions mm				weight kg/‰ pcs.	crimping-tools/page no.
uncoated	tinned	prime conductor	branch conductor	d <sub>1</sub>	d <sub>2</sub>	L	B		
03990	03990/vz	70	70	10,8	17	34	28	62,20	pages no. 173, 183, 199, 200
03991	03991/vz	95	95	13	22	40	30	97,60	
03992	03992/vz	120	120	15,5	24	45	25	102,40	

**Reduction sleeves**

for non tension connectors

acc. to DIN 46267 part 1 and similar

Material: E-copper

Surface: uncoated

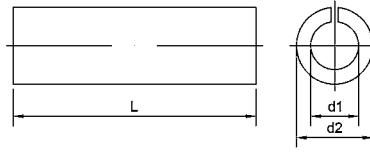
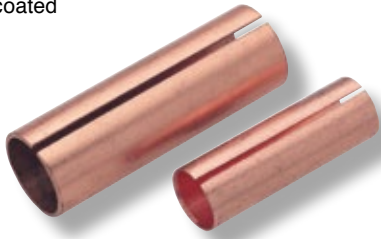

Part-No.	reduction		d <sub>1</sub>	dimensions mm		weight kg/% pcs.	crimping-tools/page no.
	from cross-section mm <sup>2</sup>	to cross-section mm <sup>2</sup>		d <sub>2</sub>	L		
02150	25	10	4,6	6,6	25	0,50	pages no. 162-200
02151		16	5,5			0,35	
02152	35	10	4,5	8	25	0,85	
02153		16	5,5			0,70	
02154		25	7			0,50	
02155	50	16	5,5	9,5	33	1,40	
02156		25	7			1,15	
02157		35	8,5			0,60	
02158	70	25	7	11	33	1,90	
02159		35	8,5			1,40	
02160		50	10			0,80	
02161	95	35	8,5	13	45	3,40	
02162		50	10			2,60	
02163		70	11,5			1,60	
02164	120	50	10	15	45	4,30	
02165		70	11,5			3,30	
02166		95	13,5			1,80	
02167	150	70	11,5	16,5	53	5,70	
02168		95	13,5			3,90	
02169		120	15,5			1,80	
02170	185	95	13,5	18,5	53	6,50	
02171		120	15,5			4,40	
02172		150	17			2,70	
02173	240	120	15,5	21	55	8,40	
02174		150	17			6,60	
02175		185	19			4,00	
02176	300	150	17	24	58	12,30	
02177		185	19			9,60	
02178		240	21,5			5,60	
02179	400	185	19	27	80	21,80	
02180		240	21,5			15,50	
02181		300	24,5			8,80	

By reduction of more than two cross-section-ranges we recommend to work with hydraulic tools with wide die sets acc. to our catalogue pages 206 or 207.

**Cable connectors in special design**

Additionally to our standardized program we are able to deliver cable lugs and connectors in special design acc. to your drawings or wishes. Following some examples:

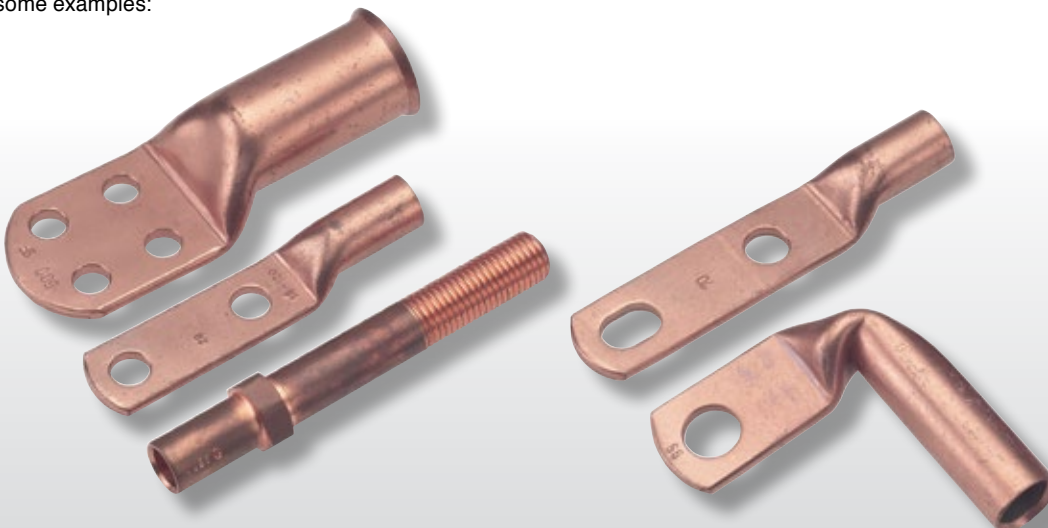

# 1. ELECTRICAL CONNECTION- AND INSTALLATION TECHNIQUE

## 1.7 Compression lugs and connectors made out of aluminium and bimetallic material

Our aluminium cable lugs are manufactured out of solid aluminium bars acc. to DIN 46329. Compared with tubular cable lugs they are longitudinally sealed. The aluminium compression connectors are acc. to DIN 46267 part 2.

To realize a connecting of copper- and aluminium conductors we offer bi-metallic cable lugs and connectors as well as bimetallic sheets and washers. All aluminium sleeves are filled with contact grease and protected against drying up. The cable lugs and connectors are grave with a code number acc. to the DIN-regulation and it is necessary to pay attention to crimp the connectors exclusively with the right tool and the right die-set which must have the same code number like the connector. The number of the necessary crimping operations depends on the lines on the connecting sleeves and the crimping width of the used compression dies. Additionally to the bimetallic cable lugs and connectors we deliver cut-outs of bimetallic sheets too.

Please notice, that the crimping operations will be done exclusively with the right tools and the right compression dies suitable for the used cable lugs or connectors.

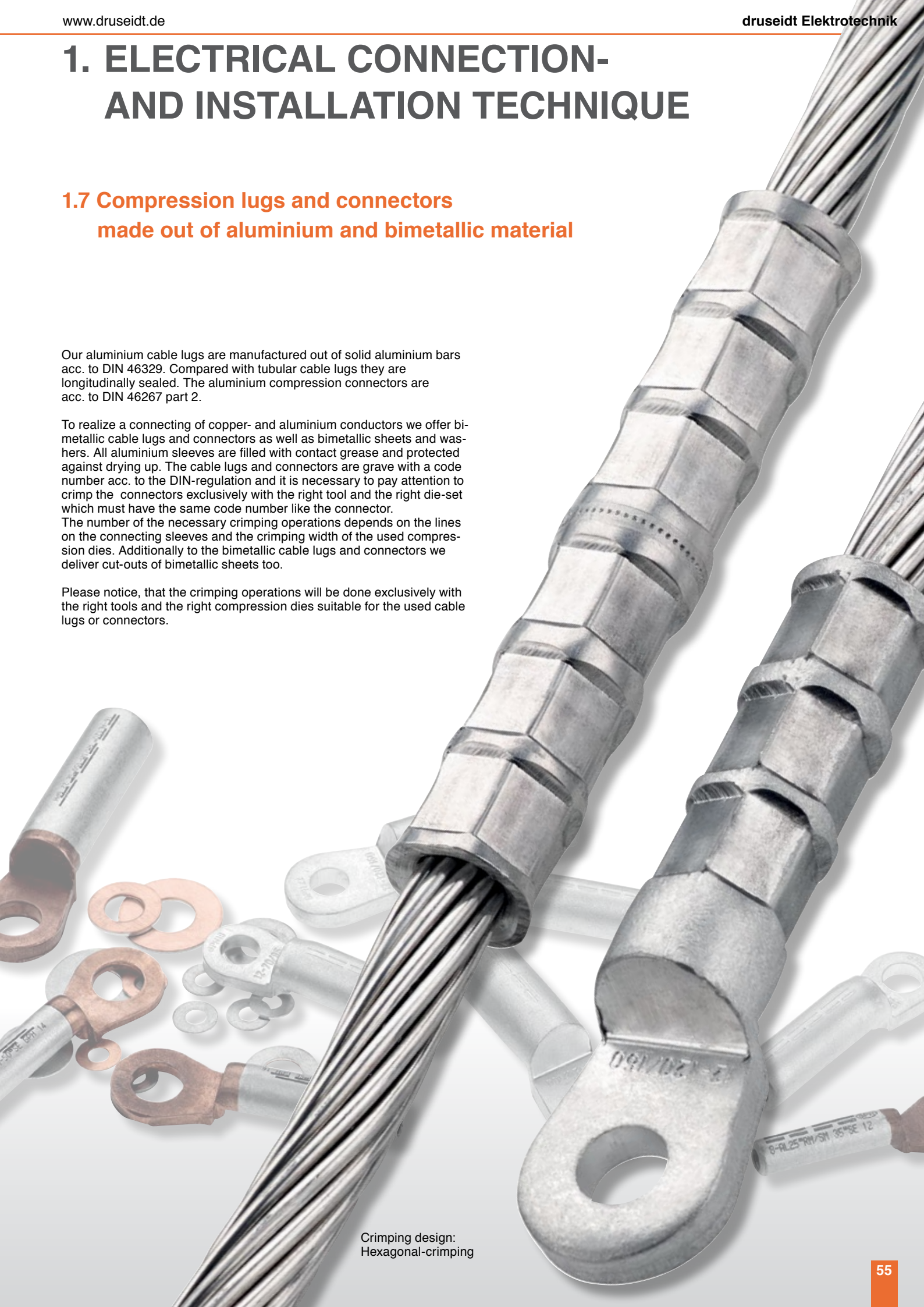

Crimping design:  
Hexagonal-crimping

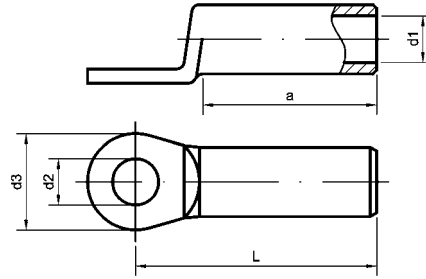

**Al-cable lugs 16-500 mm<sup>2</sup>  
longitudinally sealed acc. to DIN 46329**

 Material: Al 99,5  
 Surface: uncoated

Part-No.	cross-section mm <sup>2</sup>		drilling M	index-no.	dimensions mm					weight kg/% pcs.	crimping-tools/page no.
	rm/sm	se			d <sub>1</sub>	d <sub>2</sub>	d <sub>3</sub>	L	a		
40010	16	25	8	12	5,4	8,5	20	50	30	1,4	05256 page no. 199 12766 page no. 172; 12965/S, 12968 page no. 173; 14240-42 page no. 177; 12748 page no. 179; 13552 page no. 181; 13551/25; 13552/42; 13537 page no. 183; 12485-87; 12836, page no. 199; 12724 page no. 190; 12837/page no. 200 31460 page no. 169; 12728 page no. 188 12930, 12933 page no. 171, 12869 page no. 162 30460 page no. 167 12725 page no. 186 12655 page no. 165
40011			10			10,5				1,3	
40014	25	35	8	12	6,8	8,5	20	50	30	1,5	
40015			10			10,5	25			1,4	
40016			12			13	25			1,4	
40019	35	50	8	14	8	8,5	25	62	42	2,6	
40020			10			10,5				2,4	
40021			12			13				2,3	
40024	50	70	8	16	9,8	8,5	25	62	42	2,5	
40025			10			10,5				2,4	
40026			12			13				2,3	
40029	70	95	8	18	11,2	8,5	25	72	52	3,6	
40030			10			10,5				3,5	
40031			12			13				3,3	
40034	95	120	10	22	13,2	10,5	25	75	56	7,4	
40035			12			13				7,0	
40036			16			17	30	80		6,7	
40039	120	150	10	22	14,7	10,5	30	80	56	7,0	
40040			12			13				6,8	
40041			16			17				6,5	
40044	150	185	10	25	16,3	10,5	30	90	60	8,8	
40045			12			13				8,4	
40046			16			17				9,3	
40049	185	240	10	28	18,3	10,5	30	91	60	11,1	
40050			12			13				11,0	
40051			16			17				11,0	
40054	240	300	12	32	21	13	38	103	70	15,9	
40055			16			17				15,5	
40056			20			21				15,2	
40059	300	–	12	34	23,3	13	38	103	70	17,6	
40060			16			17				17,4	
40061			20			21				17,4	
40064	400	–	12	38	26	13	38	116	73	36,0	
40065			16			17				34,0	
40066			20			21				35,5	
40069	500	–	12	44	29	13	44	122	79	40,5	
40070			16			17				40,3	

Suitable for aluminium conductors acc. to DIN 48201 and aluminium cable conductors acc. to DIN VDE 0295. Sector shaped conductors must be rounded with special dies. All cable lugs are filled with contact grease and sealed in plastic. On request it is possible to deliver all dimensions in a tin plated design.

**Al-compression lugs 16-1000 mm<sup>2</sup>****DIN 46267 part 2**

for non tension connections 1-10 kV

Material: Al 99,5

Surface: uncoated

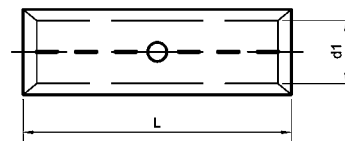

Part-No.	cross-section mm <sup>2</sup>		index-no.	dimensions mm		weight kg/% pcs.	crimping-tools/page no.
	rm/sm	se		d <sub>1</sub>	L		
02070	16	25	10	5,4	55	1,3	pages no. 165-200
02071	25	35	12	6,8	70	1,6	
02072	35	50	14	8	85	2,6	
02073	50	70	16	9,8	85	3,2	
02074	70	95	18	11,2	105	5,3	
02075	95	120	22	13,2	105	7,6	
02076	120	150	22	14,7	105	7,8	
02077	150	185	25	16,3	125	10,7	
02078	185	240	28	18,3	125	14,3	
02079	240	300	32	21	145	20,3	
02080	300	-	34	23,3	145	22,2	
10240	400	-	38	26	210	48,2	
10241	500	-	44	29	210	56,0	
10242	625	-	52	35	330	122,7	
10243	800	-	58	40	350	129,0	
10244	1000	-	60	44	350	142,0	

Suitable for aluminium and Al-alloy conductors acc. to DIN 48201 and aluminium cable conductors acc. to DIN VDE 0295. Sector shaped conductors must be rounded with special dies. All connectors are filled with contact grease and sealed in plastic.

**Al-compression lugs 16-300 mm<sup>2</sup>****with oil-stop**

for non tension connections 1-10 kV

Material: Al 99,5

Surface: uncoated

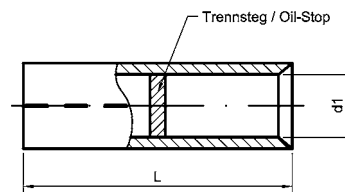

Part-No.	cross-section mm <sup>2</sup>		index-no.	dimensions mm		weight kg/% pcs.	crimping-tools/page no.
	rm/sm	se		d <sub>1</sub>	L		
10250	16	25	12	5,4	75	1,5	pages no. 165-200
10251	25	35	12	6,8	75	1,8	
10252	35	50	14	8	90	3,0	
10253	50	70	16	9,8	90	3,8	
10254	70	95	18	11,2	110	5,7	
10255	95	120	22	13,2	110	8,9	
10256	120	150	22	14,7	110	8,6	
10257	150	185	25	16,3	130	11,2	
10258	185	240	28	18,3	130	16,4	
10259	240	300	32	21	150	20,8	
10260	300	-	34	23,3	155	27,5	

Suitable for aluminium cables acc. to DIN VDE 0295. Sector shaped conductors must be rounded with special dies. All conductors are filled with contact grease and sealed in plastic. On request it is possible to deliver cross-sections up to 1000 mm<sup>2</sup>.

**Bimetallic cable lugs 16-300 mm<sup>2</sup>**

longitudinally sealed with solid copper palm

Material: barrel Al 99,5, palm Cu-HCP

Surface: uncoated

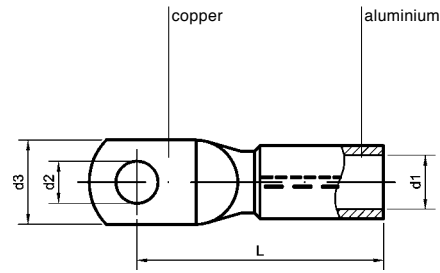

Part-No.	cross-section mm <sup>2</sup>		drilling M	index-no.	dimensions mm				weight kg/% pcs.	crimping-tools/page no.
	rm/sm	se			d <sub>1</sub>	d <sub>2</sub>	d <sub>3</sub>	L		
40100	16	25	8	12	5,4	8,5	25	63,5	2,8	12766 page no. 172; 12965/S; 12968 page no. 173; 14240-42 page no. 177; 12748 page no. 179; 13552 page no. 181; 13551/25, 13551/42, 13537 page no. 183; 12485-87, 12836, 05256, page no. 199; 12724 page no. 190; 12837 page no. 200
40101			10			10,5			2,6	
40102			12			13			2,5	
40106	25	35	8	12	6,8	8,5	25	63,5	3,0	12930, 12933 page no. 171, 12869 page no. 162
40107			10			10,5			2,8	
40108			12			13			2,8	
40112	35	50	8	14	8	8,5	25	74,5	5,2	31460 page no. 169; 12728 page no. 188
40113			10			10,5			4,8	
40114			12			13			4,6	
40115			16			17	30	79	5,0	12491 page no. 199
40119	50	70	8	16	9,8	8,5	25	75,5	5,0	
40120			10			10,5			4,8	
40121			12			13			4,8	30460 page no. 167
40122			16			17	30	80	5,5	
40126	70	95	8	18	11,2	8,5	25	83,5	7,0	
40127			10			10,5			7,0	12655 page no. 165
40128			12			13			6,5	
40129			16			17	30	88	6,5	
40134	95	120	10	22	13,2	10,5			14,8	12725 page no. 186
40135			12			13			14,0	
40136			16			17	30	91	14,4	
40142	120	150	12	22	14,7	13			13,6	12930, 12933 page no. 171, 12869 page no. 162
40143			16			17			13,4	
40149	150	185	12	25	16,3	13			17,6	
40150			16			17			16,8	31460 page no. 167
40151			20			21	38	109	18,6	
40155	185	240	10	28	18,3	10,5	30	107	22,2	
40156			12			13			22,0	12655 page no. 165
40157			16			17			20,2	
40158			20			21	38	111	22,4	
40162	240	300	10	32	21	10,5	38	120	32,0	12491 page no. 199
40163			12			13			31,8	
40164			16			17			31,0	
40165			20			21			32,4	12725 page no. 186
40169	300	-	12	34	23,3	13			33,7	
40170			16			17			32,9	
40171			20			21			32,0	

Suitable for aluminium conductors acc. to DIN 48201 and aluminium cable conductors acc. to DIN VDE 0295. Sector shaped conductors must be rounded. All cable lugs are filled with contact grease and sealed in plastic.

**Bimetallic compression lugs 25-300 mm<sup>2</sup>**

for non tension connections 1-10 kV

Material: Al 99,5 Cu-HCP

Surface: uncoated

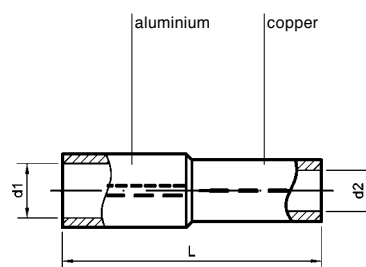
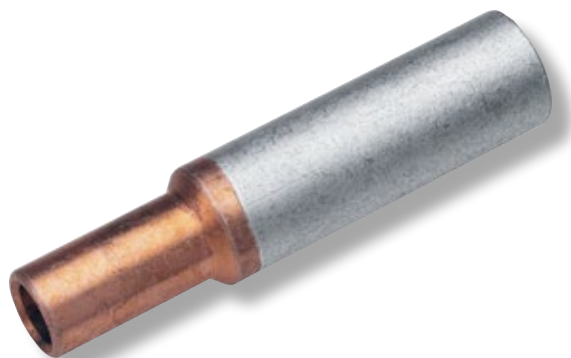

Part-No.	cross-section mm <sup>2</sup>			index-no.		dimensions mm			weight kg/% pcs.	crimping-tools/page no.
	rm/sm	Al se	Cu rm/sm	Al	Cu	d <sub>1</sub>	d <sub>2</sub>	L		
40201	25	35	10	12	6	6,8	4,5	72	1,4	12766 page no. 172; 12965/S; 12966 page no. 173; 14240-42 page no. 177; 12748 page no. 179; 13552 page no. 181; 13551/25; 13551/42; 13537 page no. 183; 12485-87; 12836; 05256; page no. 189; 12724 page no. 190; 12837 page no. 200
40202			16		8		5,5		1,7	
40203			25		10		7		1,9	
40204			35		12		8,2		3,5	
40208	35	50	16	14	8	8	5,5	80	2,5	
40209			25		10		7		2,7	
40210			35		12		8,2		3,3	
40211			50		14		10		3,5	
40215	50	70	16	16	8	9,8	5,5	82	2,9	
40216			25		10		7		3,2	
40217			35		12		8,2		3,8	
40218			50		14		10		4,6	
40222	70	95	50	18	14	11,2	10	94	5,7	
40223			70		16		11,5		7,3	
40224			95		18		13,5	101	9,4	
40228	95	120	50	22	14	13,2	10	99	8,1	
40229			70		16		11,5		8,2	
40230			95		18		13,5	105	10,4	
40231			120		20		15,5	105	11,6	
40235	120	150	70	22	16	14,7	11,5	98	8,5	
40236			95		18		13,5	106	11,0	
40237			120		20		15,5	106	11,9	
40241	150	185	70	25	16	16,3	11,5	113	10,4	
40242			95		18		13,5	117	12,7	
40243			120		20		15,5	117	13,9	
40244			150		22		17	123	16,7	
40248	185	240	95	28	18	18,3	13,5	119	14,5	
40249			120		20		15,5	119	15,9	
40250			150		22		17	125	19,6	
40251			185		25		19	127	21,0	
40255	240	300	95	32	18	21	13,5	126	19,0	
40256			120		20		15,5	126	20,5	
40257			150		22		17	132	23,3	
40258			185		25		19	134	25,5	
40259			240		28		21,5	140	30,1	
40261	300	-	120	34	20	23,3	15,5	136	27,8	
40262			150		22		17	136	31,1	
40263			185		25		19	138	32,7	
40264			240		28		21,5	144	37,5	
40265			300		32		24,5	150	41,7	

Suitable for aluminium and copper conductors acc. to DIN 48201 or Al- and copper-cable conductors acc. to DIN VDE 0295. Sector shaped conductors must be rounded. The Al-part is filled with contact grease and the connectors are sealed in plastic.



## Bimetallic sheets and washers

Bimetallic elements consist of copper plated aluminium sheets. Since the connection area of both metals is in the middle, it is kept away from air and humidity. This material enables a secure contact and a corrosion protected connection between copper and aluminium.

Besides bimetallic sheets and spacers we can also supply cut-outs with and without holes especially for your specific application.

### Bimetallic sheets

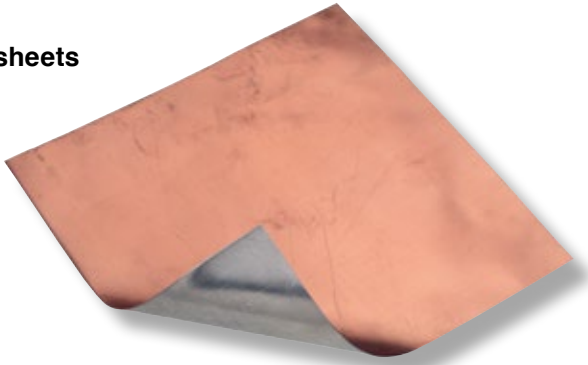

Part-No.	length mm	width mm	thickness mm	weight kg/Platte
02670	2000	500	1	4,70
02671			1,5	7,00
02672			2	9,35

### Bimetallic washers

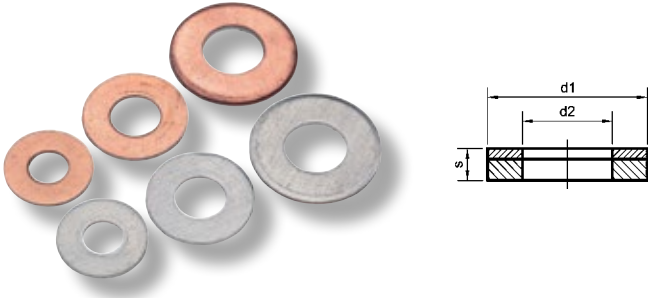

Part-No.	drilling M	dimensions mm			weight kg/% pcs.
		d <sub>1</sub>	d <sub>2</sub>	s	
13295	3	8	3,5	1	0,02
13296	4	10	4,5	1	0,03
13297	5	12	5,5	1	0,05
02675	6	15	6,5	1	0,07
02676	8	18	8,5	1	0,09
02677	10	22	10,5	1,5	0,18
02678	12	25	13	2	0,68
02679	12	28	13	2	0,44
02680	16	35	17	2	0,66

## Seal-contact-modules for high current transmission

Seal-contacts are constructed for high-current transmission with bus-bars and sheets (copper/copper, Alu/copper or Alu/Alu) in indoor as well as outdoor-installations. It is possible to connect uncoated, unmachined and uncleaned bus-bars or sheets also in corrosive atmospheres (e.g. sulphur dioxide, salt laden air, chlorine etc.). The modules are suitable for bolted joints in bus-bars according to DIN. By using these elements the high current transmission is made in hermetically sealed chambers, so that no oxidation or corrosion is possible.

So you get low loss over a long time of use. The torsion springlouver of the multilam permits the contact force as well as the electrical performance of the bus bar joint to remain constant even when the compression force drops to 50 % of its initial value. The torsion springlouver of the multilam get through the oxydlayer of the bus bar, so that a cleaning or coating of the contact areas is not necessary. So screw connections with low loss and without any servicing over a long time of use is guaranteed.

Part-No.	description	rated current	length mm	width mm	thickness mm
02696	contact module	800 A	40	13,33	1,4
02697	support module long	-	40	13,33	1,4
02698	support module short	-	13,33	13,33	1,4

Continous operating temperature up to + 100° C, short circuit current 1 s = 20 kA.

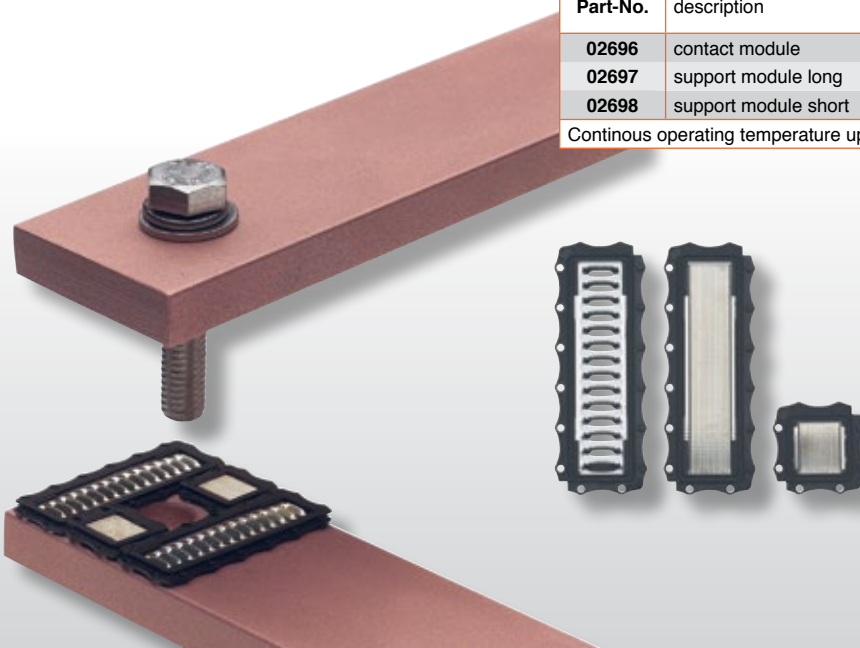

# 1. ELECTRICAL CONNECTION- AND INSTALLATION TECHNIQUE

## 1.8 Cable lugs and connectors in special design

To offer also cable lugs and connectors for ambitious application in matters of chemical and heat resistiveness too, druseidt delivers serial produced cable lugs consisting out of stainless steel or nickel material. Main application are in the range of electrical furnaces, steel-melting-plants, foundries, heating elements, anywhere where high temperatures are existent or due to the existence of chemical stress a working with copper- or aluminium connectors is not possible. Especially our cable lugs consisting out of stainless steel A4 offer a good resistance against oxidation, seawater, acids or cleaning materials. They are well suited also for application under highest hygiene requirements inside of the food- and medical production ranges. Even for chemical application where neither connectors consisting out of stainless-steel or consisting out of nickel are not resistant enough we manufacture in special design cable lugs consisting out of titan.

We recommend to crimp nickel- as well as stainless-steel connectors with an indent-crimping design. So we offer for the crimping of stainless steel lugs special compression dies. To make cable connections without crimping the conductors, we offer screwable cable lugs acc. to catalogue page 64.

Please notice, that the crimping operations will be done only with the right tools and suitable compression dies.

Crimping design:  
Indent-crimping



### Nickel cable lugs 0,5-16 mm<sup>2</sup>

Ring- and fork type

Material: Nickel tube, temperature stability up to ca. + 500° C

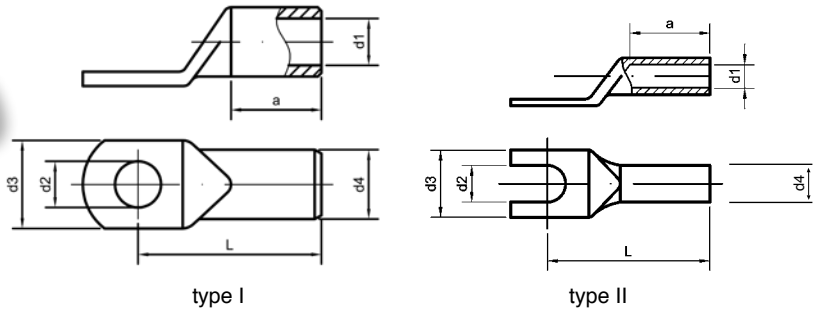

Best-Nr.		cross-section mm <sup>2</sup>	drilling M	dimensions mm				L	a	weight kg/ % pcs.	crimping-tools/page no.
type I	type II			d <sub>1</sub>	d <sub>2</sub>	d <sub>3</sub>	d <sub>4</sub>				
13254	-	0,5-1,0	3	1,6	3,2	6,5	3,2	12,5	6	0,73	30445 page no. 158 12655 page no. 163 12869 page no. 162 12724 page no. 190
13255	13265		4		4,3	7		13,5		0,84	
13256	13266		5		5,3	7,5		14,5		0,90	
13257	13267	1,5-2,5	4	2,3	4,3	7	3,9	14	6	1,14	
13258	13268		5		5,3	8,5		15,5		1,23	
13259	13269		6		6,4	9,5		17		1,33	
13260	13270	4-6	4	3,6	4,3	9,4	5,6	18	8	2,57	
13261	13271		5		5,3	10		18,5		2,66	
13262	13272		6		6,4	10,5		19,5		2,90	
13262/8	-		8		8,4	12,5		22		3,19	
13263	13273	10	5	4,5	5,3	10,8	6,5	20,5	10	3,40	
13264	13274		6		6,4	11,5		22,5		3,70	
13264/8	13274/8		8		8,4	13,3		25		4,20	
13414	13417	16	5	5,5	5,3	12,8	7,5	22,5	11	4,40	
13415	13418		6		6,4	13,6		24,5		4,80	
13416	13419		8		8,4	15,7		26,5		5,40	

### Nickel connectors 0,5-16 mm<sup>2</sup>

Material: Nickel tube, temperature stability up to ca. + 500° C

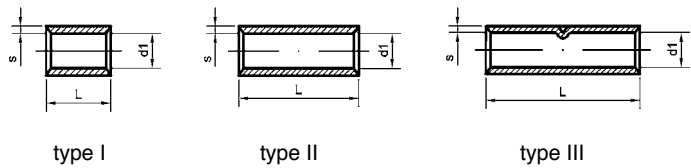

Part-No.	cross-section mm <sup>2</sup>	type	d <sub>1</sub>	dimensions mm		weight kg/ % pcs.	crimping-tools/page no.
				L	s		
<b>Parallel connectors</b>							
01980	0,5-1,0	I	1,6	7	0,8	0,40	30445 page no. 160
01981	1,5-2,5		2,3		0,8	0,50	
01982	4-6		3,6		1,0	0,90	
<b>Butt connectors without wire stop</b>							
01985	0,5-1,0	II	1,6	15	0,8	0,85	30445 page no. 160
01986	1,5-2,5		2,3		0,8	1,10	
01987	4-6		3,6		1,0	1,90	
<b>Butt connectors with wire stop</b>							
13275/15	0,5-1,0	III	1,6	15	0,8	0,82	12650, 12655 pages no. 164/165
13275				25	0,8	1,35	
13276/15	1,5-2,5	III	2,3	15	0,8	1,04	
13276				25	0,8	1,70	
13277/15	4-6	III	3,6	15	1,0	1,92	
13277				25	1,0	3,25	
13278	10	III	4,5	25	1,0	3,80	
13279	16			30	1,0	5,40	

## Tubular cable lugs 1,5-95 mm<sup>2</sup> out of stainless steel

Material: stainless steel 1.4571 (V4A)  
Temperature stability up to ca. + 400° C

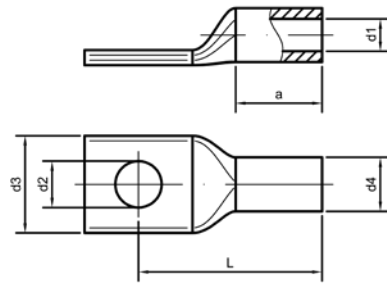

Part-No.	cross-section mm <sup>2</sup>	drilling M	dimensions mm				L	a	weight kg/‰ pcs.	crimping-tools/page no.
			d <sub>1</sub>	d <sub>2</sub>	d <sub>3</sub>	d <sub>4</sub>				
10905	1,5 - 2,5	4	3	4,3	9	5	22,5	8	2,70	12930, 12933 page no. 171; 14240/42 page no. 177; 12748 page no. 179; 12728 page no. 188  12965/S, 12968 page no. 179; 13551/25, 13551/42, 13537 page no. 183; 12485-87, 12837 page no. 199; 12869 page no. 162; 12724 page no. 190
10906		5		5,3	9		21,5		2,60	
10907		6		6,4	10		20		2,50	
10910	4 - 6	4	4	4,3	9	6	23,5	9	3,30	
10911		5		5,3	9		22,5		3,40	
10912		6		6,4	10		21		3,30	
10915	10	5	5	5,3	12	8	29	10	8,10	
10916		6		6,4	12		27,5		8,00	
10917		8		8,4	13		25		7,60	
10920	16	5	6	5,3	12	8	36	16	7,30	
10921		6		6,4	12		34,5		7,20	
10922		8		8,4	13		32		7,00	
10925	25	6	7	6,4	14	10	33,5	15	12,60	
10926		8		8,4	16		31		12,50	
10930	35	6	9	6,4	18	12	39,5	17	18,60	
10931		8		8,4	18		37		18,10	
10932		10		10,5	20		36		17,90	
10936	50	8	10	8,4	21	14	43	19	31,00	
10937		10		10,5	21		42		30,70	
10938		12		13	23		40		29,50	
10940	70	8	12	8,4	24	16	53	21	44,60	
10941		10		10,5	24		52		43,70	
10942		12		13	24		50		42,40	
10943		16		17	28		47		41,70	
10945	95	8	14	8,4	26	18	58	25	56,00	
10946		10		10,5	26		57		55,00	
10947		12		13	26		55		53,60	
10948		16		17	28		52		51,90	

## Cable lugs out of titanium

In cases where the chemical stability of our stainless steel or nickel connectors are insufficient we manufacture on request also cable lugs out of titanium material.



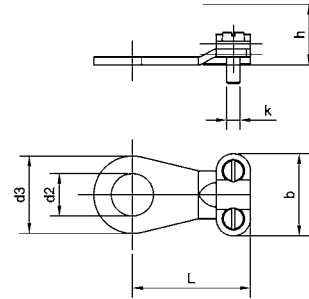

**Punched cable lugs 6-35 mm<sup>2</sup>**

 Material: Cu-ETP  
 Surface: uncoated

Part-No.		cross-section mm <sup>2</sup>	drilling M	drilling		dimensions mm				weight kg/%pcs.
with steel screws	with bronze screws			d <sub>2</sub>	d <sub>3</sub>	b	h	L	k	
02250	02270	6-10	6	6,5	15	18	10	23	M4	1,20
02251	02271	16	6	6,5	15	20,5	14	27	M5	1,90
02252	02272	16	8	8,5	15	20,5	14	27	M5	1,90
02253	02273	25	8	8,5	15	25	16	30	M5	2,90
02254	02274	35	8	8,5	18,5	24	19	25,5	M5	3,51

Tin plated designs on request.

**Punched cable lugs 25-240 mm<sup>2</sup>**

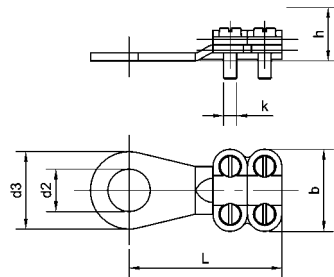
 Material: Cu-ETP  
 Surface: uncoated

Part-No.		cross-section mm <sup>2</sup>	drilling M	drilling		dimensions mm				weight kg/%pcs.
with steel screws	with bronze screws			d <sub>2</sub>	d <sub>3</sub>	b	h	L	k	
02255	02275	25	8	8,5	18,5	22,5	16	36	M5	4,10
02256	02276	25	10	10,5	19,5	22,5	16	37	M5	4,10
02257	02277	35	8	8,5	18,5	24	16	38,5	M5	4,40
02258	02278	35	10	10,5	21,5	24	16	42	M5	4,40
02259	02279	35	12	13	21,5	24	16	42	M5	4,40
02260	02280	50	10	10,5	19	28	19	46	M6	7,00
02261	02281	50	12	13	21	28	19	47	M6	7,00
02262	02282	70	10	10,5	23,5	31	19	51	M6	10,00
02263	02283	70	12	13	23,5	31	19	51	M6	10,00
02264	02284	95	10	10,5	24	34	25	57	M6	12,00
02265	02285	95	12	13	24	34	25	57	M6	12,00
02266		120	12	13	29	39	27	60	M7	17,40
10452	10453	150	16	17	30	42	29	61,5	M8	20,00
02267	02287	185 - 240	16	17	34	48,5	32	68,5	M8	27,00

Tin plated designs on request.

# 1. ELECTRICAL CONNECTION- AND INSTALLATION TECHNIQUE

## 1.9 Cable end sleeves

To prevent a fan out of wires especially when working with flexible or highly flexible leadings and to guarantee optimized electrical connections, it is necessary to crimp cable end sleeves at the conductor ends. Additionally to the designs acc. to DIN 46228 part 1 + 4 different kinds in special design are offered too.

Here we would like to point out our Twin-cable end sleeves for connecting two leadings in one sleeve or our cable end sleeves for short circuit proof cables with bigger insulation sleeve. To offer an economically processing we deliver up to a cross-section range of 2,5 mm<sup>2</sup> a strip-form design too. For such designs we recommend to work with our Quadro-tool acc. to the description on catalogue page 150. This tool enables a cutting, stripping and twisting of the conductors as well as a crimping of the cable end sleeves by using only one tool.

Possible crimping designs are the trapezoid-, square- as well as double W-crimping. Our wide crimping tool program is described on catalogue pages 147 ff.

Please notice, that all crimping operations will be done only with the right tools and suitable compression dies. Only the use of high quality tools guarantee an optimized and professional crimping result.

Crimping design:  
Trapezoid-, square-  
or double W-crimping

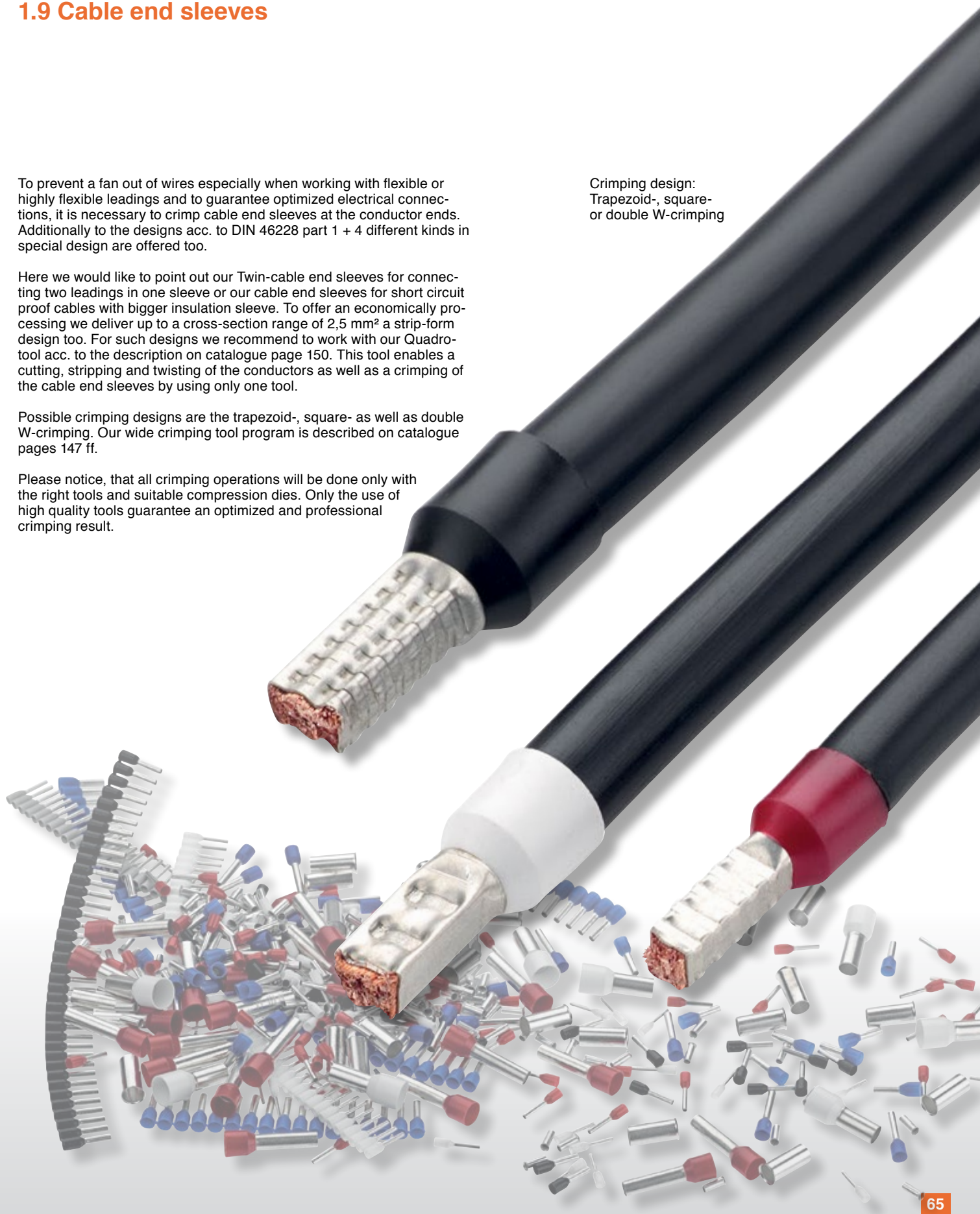

**Cable end sleeves 0,25-25 mm<sup>2</sup>**

 in acc. with DIN 46228 page 1  
 and special design

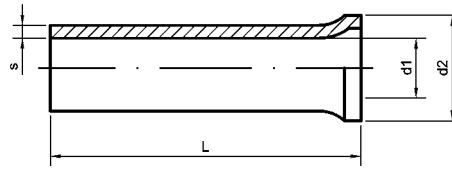
 Material: copper acc. to DIN 13600  
 Surface: tinned

Part-No.	cross-section mm <sup>2</sup>	size	dimensions mm				weight kg/‰ pcs.	crimping-tools/page no.
			d <sub>1</sub>	d <sub>2</sub>	L	s		
01206	0,25	5 - 0,25	0,75	1,7	5	0,15	0,02	
01207		7 - 0,25			7			
01208	0,34	5 - 0,34	0,85	1,8	5	0,15	0,02	
01209		7 - 0,34			7			
01210	0,5	6 - 0,5	1	2,1	6	0,15	0,03	
13199		8 - 0,5			8			
13200		10 - 0,5			10			
01211	0,75	6 - 0,75	1,2	2,3	6	0,15	0,04	
01212		8 - 0,75			8			
13201		10 - 0,75			10			
13600		15 - 0,75			15			
01213	1	6 - 1	1,4	2,5	6	0,15	0,05	
13601		8 - 1			8			
01214		10 - 1			10			
13602		12 - 1			12			
13603		15 - 1			15			
01215	1,5	7 - 1,5	1,7	2,8	7	0,15	0,06	
01216		10 - 1,5			10			
01217		12 - 1,5			12			
13604		15 - 1,5			15			
13202		18 - 1,5			18			
13605		20 - 1,5			20			
01218	2,5	7 - 2,5	2,2	3,4	7	0,15	0,08	
13203		10 - 2,5			10			
01219		12 - 2,5			12			
13607		15 - 2,5			15			
13204		18 - 2,5			18			
13608		20 - 2,5			20			
01220	4	9 - 4	2,8	4	9	0,2	0,16	
01221		12 - 4			12			
13205		15 - 4			15			
13206		18 - 4			18			
13609		20 - 4			20			
01222	6	10 - 6	3,5	4,7	10	0,2	0,23	
01223		12 - 6			12			
01224		15 - 6			15			
13207		18 - 6			18			
13610		20 - 6			20			
13611		25 - 6			25			
01225	10	12 - 10	4,5	5,8	12	0,2	0,33	
01226		15 - 10			15			
01227		18 - 10			18			
13612		20 - 10			20			
13613		25 - 10			25			
01228	16	12 - 16	5,8	7,5	12	0,2	0,43	
01229		15 - 16			15			
01230		18 - 16			18			
13208		25 - 16			25			
13209		32 - 16			32			
01231	25	15 - 25	7,3	9,5	15	0,2	0,79	
01232		18 - 25			18			
13614		20 - 25			20			
13615		25 - 25			25			
13616		28 - 25			28			

12230 page no. 156/157; Further tool-solutions are contained on pages no. 167 ff

12637 page no. 148

12430, 12408, 12425, pages no. 158/159, 05160 page no. 153, 12655 from 6 mm<sup>2</sup> page no. 164; 05184 from 10 mm<sup>2</sup> page no. 150

12648 page no. 150

12646 from 0,14 mm<sup>2</sup>; 05140 from 0,25 mm<sup>2</sup> page no. 149; 05124 from 0,5 mm<sup>2</sup> page no. 148

12640 from 0,08 mm<sup>2</sup> page no. 149; 05130 page no. 148

05144 from 0,08 mm<sup>2</sup>; 12641 from 2,5 mm<sup>2</sup> page no. 149; 05125, 12858 from 0,5 mm<sup>2</sup> pages no. 148/153, 05122 from 0,75 mm<sup>2</sup> page no. 148; 05131 page no. 148

12648 page no. 150

### Cable end sleeves 35-185 mm<sup>2</sup> in acc. with DIN 46228 page 1 and special design

Material: copper acc. to DIN 13600  
Surface: tinned

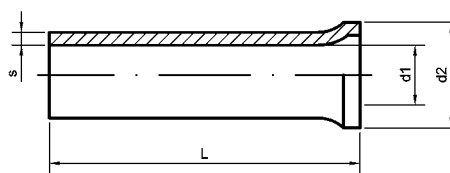

Part-No.	cross-section mm <sup>2</sup>	size	dimensions mm				weight kg/% pcs.	crimping-tools/page no.
			d <sub>1</sub>	d <sub>2</sub>	L	s		
01233	35	15 - 35	8,3	11	15	0,2	31460 pages no. 169/170; 12766 page no. 172; 12965/S; 12968 page no. 173; 14240/41 pages no. 176/177; 13552 pages no. 180/181; 13551/25; 13551/42; 13537, pages no. 182/183; 12836, 12485, 12486, 12487 page no. 199; 12837 page no. 200 30460 pages no. 167/168; 12930, 12933 page no. 171; 12748 pages no. 178/179; 12740/42 pages no. 176/177 12649, 05184 page no. 150; 05160 page no. 153; 12430, 12408, 12425 pages no. 158/159; 12230 page no. 156/157; 12655 pages no. 165/166	
01234		18 - 35			18			
01235		22 - 35			22			
01236		25 - 35			25			
01237		30 - 35			30			
01238		32 - 35			32			
13617	50	18 - 50	10,5	13	18	0,3		
13618		22 - 50			22			
13619		25 - 50			25			
13620		30 - 50			30			
13621		32 - 50			32			
13622	70	22 - 70	12,7	15	22	0,4		
13623		25 - 70			25			
13624		30 - 70			30			
13625		32 - 70			32			
13626	95	25 - 95	14,7	17	25	0,4		
13627		30 - 95			30			
13628		32 - 95			32			
13629		34 - 95			34			
13630	120	30 - 120	16,7	19	30	0,5		
13631		32 - 120			32			
13632		34 - 120			34			
13633		38 - 120			38			
13634		40 - 120			40			
13635	150	32 - 150	18,7	21	32	0,5		
13636		34 - 150			34			
13637		38 - 150			38			
13638		40 - 150			40			
13639	185	32 - 185	20,2	23,5	32	0,6		
13640		40 - 185			40			

### Assortment boxes

filled with uninsulated cable end sleeves  
in acc. with DIN 46228 page 1



Part-No.	content			Part-No.	content			Part-No.	content			
01300	500 St.	6 - 0,5	# 01210	01301	100 pcs.	9 - 4	# 01220	01302	unfilled with 5 partition			
	500 St.	6 - 0,75	# 01211		100 pcs.	10 - 6	# 01222		01303	unfilled with 4 partition		
	500 St.	6 - 1	# 01213		50 pcs.	18 - 10	# 01227					
	300 St.	7 - 1,5	# 01215		25 pcs.	18 - 16	# 01230					
	200 St.	7 - 2,5	# 01218									



### Insulated cable end sleeves 0,14-150 mm<sup>2</sup>

Colour: usual in trade design

Material: copper acc. to DIN EN 13600

Surface: tinned

Insulation sleeve: PP

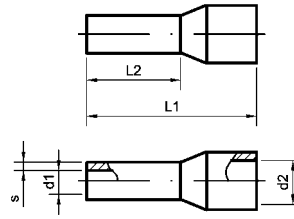

Part-No.	colour	Part-No.	colour	cross-section mm <sup>2</sup>	size	dimensions mm					weight kg/% pcs.	crimping-tools/page no.
						L <sub>1</sub>	L <sub>2</sub>	d <sub>1</sub>	d <sub>2</sub>	s		
55993	brown	56038	grey	0,14	6 - 0,14	10	6	0,7	1,6	0,15	0,047	12646 from 0,14 mm <sup>2</sup> ; 05140 from 0,25 mm <sup>2</sup> page no. 149; 05124 from 0,5 mm <sup>2</sup> page no. 148 12640 from 0,08 mm <sup>2</sup> page no. 149; 05130 page no. 148 05144 from 0,08 mm <sup>2</sup> ; 12641 from 2,5 mm <sup>2</sup> page no. 149; 05125; 12858 from 0,5 mm <sup>2</sup> page no. 148; 05122 from 0,75 mm <sup>2</sup> page no. 148; 05131 page no. 148 12430, 12408, 12425 pages no. 158/159; 05160 page no. 153; 12655 from 6 mm <sup>2</sup> pages no. 163/164; 05184 from 10 mm <sup>2</sup> page no. 150; 12230 page no. 156/157
55994		56039			8 - 0,14	12	8				0,055	
55995	violet	56040	light blue	0,25	6 - 0,25	10	6	0,75	1,8	0,15	0,047	
55996		56041			8 - 0,25	12	8				0,057	
55997	pink	56042	turquoise	0,34	6 - 0,34	10	6	0,8	2	0,15	0,047	
55998		56043			8 - 0,34	12	8				0,055	
55999	white	56044	orange	0,5	6 - 0,5	12	6	1	2,6	0,15	0,063	
56000		56045			8 - 0,5	14	8				0,075	
56000/1		56046			10 - 0,5	16	10				0,085	
56001/1	blue	56047	white	0,75	6 - 0,75	12	6	1,2	2,8	0,15	0,077	
56001		56048			8 - 0,75	14	8				0,089	
56001/2		56049			10 - 0,75	16	10				0,100	
56001/3		56050			12 - 0,75	18	12				0,110	
56002/1	red	56051	yellow	1	6 - 1	12	6	1,4	3	0,15	0,084	
56002		56052			8 - 1	14	8				0,100	
56002/2		56053			10 - 1	16	10				0,110	
56002/3		56054			12 - 1	18	12				0,125	
56003	black	56055	red	1,5	8 - 1,5	14	8	1,7	3,5	0,15	0,115	
56003/1		56056			10 - 1,5	16	10				0,130	
56003/2		56056/1			12 - 1,5	18	12				0,150	
56004		56057			18 - 1,5	24	18				0,200	
56006	grey	56058	blue	2,5	8 - 2,5	14	8	2,2	4,2	0,15	0,160	
56006/1		56059			12 - 2,5	18	12				0,200	
56007		56060			18 - 2,5	24	18				0,265	
56008	orange	56061	grey	4	10 - 4	17	10	2,8	4,8	0,2	0,270	
56008/1		56062			12 - 4	20	12				0,300	
56009		56063			18 - 4	26	18				0,440	
56010	green	56064	black	6	12 - 6	20	12	3,5	6,3	0,2	0,430	
56011		56065			18 - 6	26	18				0,550	
56012	brown	56066	white	10	12 - 10	22	12	4,5	7,6	0,2	0,560	
56013		56067			18 - 10	28	18				0,730	
56014	white	56068	green	16	12 - 16	24	12	5,8	8,8	0,2	0,820	
56015		56069			18 - 16	28	18				1,000	
56016	black	56070	brown	25	16 - 25	30	16	7,3	11,2	0,2	1,400	
56016/1		56070/1			18 - 25	30	18				1,420	
56017		56071			22 - 25	36	22				1,650	
56018	red	56072	beige	35	16 - 35	30	16	8,3	12,7	0,2	1,620	
56018/1		56072/1			18 - 35	30	18				1,700	
56019		56073			25 - 35	39	25				2,140	
56020	blue	56074	olive	50	20 - 50	36	20	10,3	15	0,3	2,990	
56021		56075			25 - 50	40	25				3,520	
-	-	56076	yellow	70	20 - 70	37	20	13,5	16	0,4	5,800	
-	-	56077	red	95	25 - 95	44	25	14,5	18	0,4	6,880	
-	-	56078	blue	120	27 - 120	48	27	16,5	20	0,45	9,360	
-	-	56079	yellow	150	32 - 150	58	32	19,5	28	0,5	13,450	

Further tools with exchangeable die sets  
page no. 169 ff

12648 page no. 150  
12649 page no. 150  
30460, 12930, 12933, 12740/41,  
12748 pages no. 167 ff

## Insulated cable end sleeves 0,5-50 mm<sup>2</sup>

in acc. with DIN 46228 page 4

Material: copper acc. to DIN EN 13600

Surface: tinned

Insulation sleeve: PP

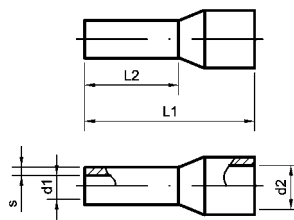

Part-No.	colour	cross-section mm <sup>2</sup>	size	dimensions mm					weight kg/‰ pcs.	crimping-tools/page no.
				L1	L2	d1	d2	s		
55999	white	0,5	6 - 0,5	12	6	1	2,6	0,15	0,063	12646 from 0,14 mm <sup>2</sup> 05140 from 0,25 mm <sup>2</sup> page no. 149; 05124, 05130 page no. 148 12430, 12408, 12425 pages no. 158/159, 05160 page no. 153; 12655 from 6 mm <sup>2</sup> pages no. 165/166; 05184 from 10 mm <sup>2</sup> page no. 150; 12230 page no. 156/157 05144 from 0,08 mm <sup>2</sup> ; 12641 from 2,5 mm <sup>2</sup> page no. 149; 05125, 12858 from 0,5 mm <sup>2</sup> page no. 148; 05122 from 0,75 mm <sup>2</sup> page no. 148; 05131 page no. 148  Tools with exchangeable crimping dies page no. 167 ff
56000			8 - 0,5	14	8				0,075	
56000/1			10 - 0,5	16	10				0,085	
56080	grey	0,75	6 - 0,75	12	6	1,2	2,8	0,15	0,077	
56081			8 - 0,75	14	8				0,085	
56082			10 - 0,75	16	10				0,100	
56083			12 - 0,75	18	12				0,110	
56002/1	red	1	6 - 1	12	6	1,4	3	0,15	0,084	
56002			8 - 1	14	8				0,100	
56002/2			10 - 1	16	10				0,110	
56002/3			12 - 1	18	12				0,125	
56003	black	1,5	8 - 1,5	14	8	1,7	3,5	0,15	0,115	
56003/1			10 - 1,5	16	10				0,130	
56003/2			12 - 1,5	18	12				0,150	
56004			18 - 1,5	24	18				0,200	
56058	blue	2,5	8 - 2,5	14	8	2,2	4,2	0,15	0,160	
56059			12 - 2,5	18	12				0,200	
56060			18 - 2,5	24	18				0,265	
56061	grey	4	10 - 4	17	10	2,8	4,8	0,2	0,270	
56062			12 - 4	20	12				0,300	
56063			18 - 4	26	18				0,440	
56084	yellow	6	12 - 6	20	12	3,5	6,3	0,2	0,430	
56085			18 - 6	26	18				0,550	
56086	red	10	12 - 10	22	12	4,5	7,6	0,2	0,560	
56087			18 - 10	28	18				0,730	
56088	blue	16	12 - 16	24	12	5,8	8,8	0,2	0,820	
56089			18 - 16	28	18				1,000	
56090	yellow	25	16 - 25	30	16	7,3	11,2	0,2	1,400	
56090/1			18 - 25	30	18				1,420	
56091			22 - 25	36	22				1,650	
56018	red	35	16 - 35	30	16	8,3	12,7	0,2	1,620	
56018/1			18 - 35	30	18				1,700	
56019			25 - 35	39	25				2,140	
56020	blue	50	20 - 50	36	20	10,3	15	0,3	2,990	
56021			25 - 50	40	25				3,520	

## Insulated cable end sleeves 0,5-2,5 mm<sup>2</sup> in strip form

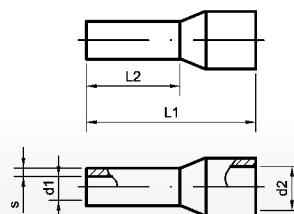
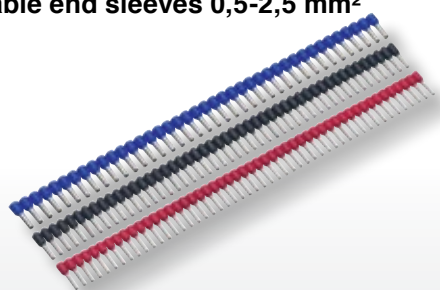

Part-No.	usual in trade design		design DIN 46228		cross-section mm <sup>2</sup>	dimensions mm					crimping-tools/page no.	
	colour	Part-No.	colour	Best-Nr.		colour	L <sub>1</sub>	L <sub>2</sub>	d <sub>1</sub>	d <sub>2</sub>		s
56000 str	weiß	56045 str	orange	56000 str	weiß	0,5	14	8	1	2,6	0,15	12510/12512 page no. 150
56001 str	blue	56048 str	white	56081 str	grau	0,75	14	8	1,2	2,8	0,15	
56002 str	red	56052 str	yellow	56002 str	red	1	14	8	1,4	3	0,15	
56003 str	black	56055 str	red	56003 str	black	1,5	14	8	1,7	3,5	0,15	
56006 str	grau	56058 str	blue	56058 str	blue	2,5	14	8	2,3	4,2	0,15	

### Insulated twin cable end sleeves with rectangular insulation sleeve for two cables 0,5-16 mm<sup>2</sup>

Material: copper acc. to DIN EN 13600

Surface: tinned

Insulation sleeve: PP

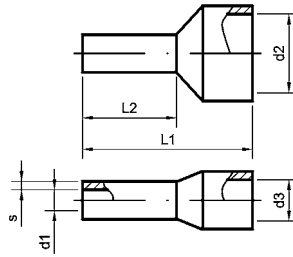

Part-No.	colour	cross-section mm <sup>2</sup>	dimensions mm						weight kg/‰ pcs.	crimping-tools/page no.
			L <sub>1</sub>	L <sub>2</sub>	d <sub>1</sub>	d <sub>2</sub>	d <sub>3</sub>	s		
57000	white	2 x 0,5	15	8	1,5	4,9	2,5	0,15	0,12	12766 p. 170; 13552 p. 178; 14240/41 p.174/175
57001	grey	2 x 0,75	15	8	1,8	5,2	2,6	0,15	0,14	
57002			19	10					0,15	
57003	red	2 x 1	16	8	2	5,8	3,2	0,15	0,16	
57004			17	10					0,18	
57005	black	2 x 1,5	16	8	2,3	6,5	3,6	0,15	0,19	
57006			20	12					0,23	
57007	blue	2 x 2,5	18	10	2,9	7,5	4,3	0,15	0,33	
57008			21	13					0,38	
57009	grey	2 x 4	23	12	3,8	9	5,2	0,2	0,52	
57010	yellow	2 x 6	26	14	4,9	10	7,2	0,2	0,72	
57011	red	2 x 10	26	14	6,5	13	7,2	0,2	0,92	
57012	blue	2 x 16	30	14	8,3	18	9,5	0,2	1,34	

05144 page no. 149; 05130 page no. 148  
 12640, 12646, 05140 page no.  
 149; 05124 page no. 148;  
 05130 (0,5 up to 10 mm<sup>2</sup>), 05131  
 (0,5 up to 16 mm<sup>2</sup>) page no. 148  
 12641, 12647  
 p.no. 149  
 12649 p. 150

### Insulated cable end sleeves 1,5-16 mm<sup>2</sup> for short circuit proof cables with thick insulation

Material: copper acc. to DIN EN 13600

Surface: tinned

Insulation sleeve: PP with flaring insulation part

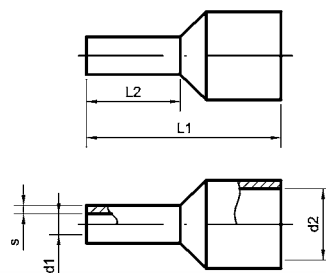
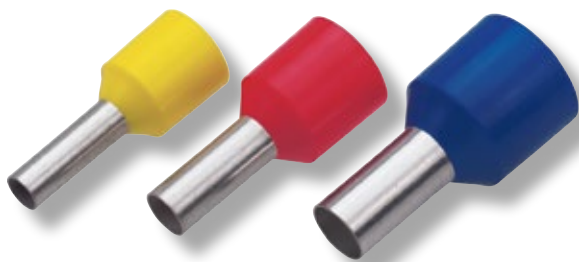

Part-No.	colour	cross-section mm <sup>2</sup>	size	dimensions mm					weight kg/‰ pcs.	crimping-tools/page no.
				L <sub>1</sub>	L <sub>2</sub>	d <sub>1</sub>	d <sub>2</sub>	s		
58000	black	1,5	8 - 1,5	17,5	8	1,8	5,9	0,15	0,25	pages no. 148-150, 153, 156-159
58002			10 - 1,5	19,5	10				0,27	
58004	blue	2,5	8 - 2,5	17,5	8	2,3	7,8	0,15	0,28	
58006			12 - 2,5	21,5	12				0,31	
58008	green	4	10 - 4	19,5	10	2,9	7,8	0,2	0,4	
58010	yellow	6	12 - 6	23	12	3,6	8,3	0,2	0,55	
58012	red	10	12 - 10	24	12	4,6	9,8	0,2	0,69	
58014	blue	16	12 - 16	25,5	12	6	12,0	0,2	0,96	

**Assortment-boxes 0,5-2,5 mm<sup>2</sup>**

filled with insulated cable end sleeves  
in acc. with DIN 46228 page 4 and special design



Part-No.	content				Part-No.	content				Part-No.	content			
<b>01305</b>	50 pcs.	8 - 0,5	white	# 56000	<b>01307</b>	50 pcs.	8 - 0,5	orange	# 56045	<b>01309</b>	50 pcs.	8 - 0,5	white	# 56000
	100 pcs.	8 - 0,75	blue	# 56001		100 pcs.	8 - 0,75	white	# 56048		100 pcs.	8 - 0,75	grey	# 56081
	100 pcs.	8 - 1	red	# 56002		100 pcs.	8 - 1	yellow	# 56052		100 pcs.	8 - 1	red	# 56002
	100 pcs.	8 - 1,5	black	# 56003		100 Stck	8 - 1,5	red	# 56055		100 pcs.	8 - 1,5	black	# 56003
	50 pcs.	8 - 2,5	grey	# 56006		50 pcs.	8 - 2,5	blue	# 56058		50 pcs.	8 - 2,5	blue	# 56058

**Assortment-boxes 4-16 mm<sup>2</sup>**

filled with insulated cable end sleeves  
in acc. with DIN 46228 page 4 and special design



Part-No.	content				Part-No.	content				Part-No.	content			
<b>01306</b>	50 pcs.	10 - 4	orange	# 56008	<b>01308</b>	50 pcs.	10 - 4	grey	# 56061	<b>01310</b>	50 pcs.	10 - 4	grey	# 56061
	20 pcs.	12 - 6	green	# 56010		20 pcs.	12 - 6	black	# 56064		20 pcs.	12 - 6	yellow	# 56084
	20 pcs.	12 - 10	brown	# 56012		20 pcs.	12 - 10	white	# 56066		20 pcs.	12 - 10	red	# 56086
	10 pcs.	12 - 16	white	# 56014		10 pcs.	12 - 16	green	# 56068		10 pcs.	12 - 16	blue	# 56088

**Assortment-boxes 0,5-6 mm<sup>2</sup>**

filled with twin cable end sleeves for double cable connection



Part-No.	content				Part-No.	content				Part-No.	content			
<b>01311</b>	50 pcs.	2 - 0,5	white	# 57000	<b>01312</b>	50 pcs.	2 - 0,75	grey	# 57001	<b>01313</b>	30 pcs.	2 - 1,5	black	# 57005
	50 pcs.	2 - 0,75	grey	# 57001		50 pcs.	2 - 1	red	# 57003		30 pcs.	2 - 2,5	blue	# 57007
	50 pcs.	2 - 1	red	# 57003		50 pcs.	2 - 1,5	black	# 57005		20 pcs.	2 - 4	grey	# 57009
	50 pcs.	2 - 1,5	black	# 57005		50 pcs.	2 - 2,5	blue	# 57007		10 pcs.	2 - 6	yellow	# 57010



**Assortment-boxes**filled with uninsulated cable end sleeves DIN 46228 page 1  
with and without crimping tools

Part-No.	dimensions mm	description	content	
<b>10480</b>	245 x 160 x 45	steel sheet varnished assortment box with 6 little, 1 tool partition and following content:	1000 x 0,75 - 6	01211
			1000 x 1,00 - 6	01213
			1000 x 1,50 - 7	01215
			500 x 2,50 - 7	01218
			500 x 4,00 - 9	01220
			500 x 6,00 - 12	01223
			1 x crimping tool	05122
<b>10481</b>	245 x 160 x 45	ditto, but with square crimping tool 05124	1 x square crimping tool	05124
<b>10482</b>	245 x 160 x 45	ditto, but without tool	without tool	
<b>10483</b>	245 x 160 x 45	steel sheet varnished assortment box with 6 little, 1 tool partition and following content:	1000 x 0,50 - 6	01210
			1000 x 0,75 - 6	01211
			1000 x 1,00 - 6	01213
			500 x 1,50 - 7	01215
			500 x 2,50 - 7	01218
			500 x 2,50 - 12	01219
			1 x crimping tool	12637
<b>10484</b>	245 x 160 x 45	ditto, but without tool	without tool	

Part-No.	dimensions mm	description	content				
<b>10485</b>	350 x 160 x 35	steel sheet varnished assortment box with 7 little, 1 tool partition and following content:	1000 x 0,75 - 6	01211			
			1000 x 1,00 - 6	01213			
			1000 x 1,50 - 7	01215			
			500 x 2,50 - 7	01218			
			500 x 4,00 - 9	01220			
			500 x 6,00 - 12	01223			
			500 x 10,00 - 12	01225			
			1 x crimping tool	05122			
			<b>10486</b>	350 x 160 x 35	ditto, but with square crimping tool 12640	1 x square crimping tool	12640
			<b>10487</b>	350 x 160 x 35	ditto, but without tool	without tool	
<b>10488</b>	350 x 160 x 35	steel sheet varnished assortment box with 12 little, 1 tool partition and following content:	1000 x 0,75 - 6	01211			
			1000 x 1,00 - 6	01213			
			1000 x 1,50 - 7	01215			
			500 x 1,50 - 10	01216			
			500 x 2,50 - 7	01218			
			500 x 2,50 - 12	01219			
			500 x 4,00 - 9	01220			
			250 x 6,00 - 12	01223			
			100 x 10,00 - 12	01225			
			100 x 10,00 - 18	01227			
			100 x 16,00 - 12	01228			
100 x 16,00 - 18	01230						
1 x crimping tool	05122						
<b>10490</b>	350 x 160 x 35	ditto, but without tool	without tool				

**Assortment-boxes**

filled with insulated cable end sleeves DIN 46228 page 4  
and Twin design  
with and without crimping tool



Part-No.	dimensions mm	description	content	
<b>10491</b>	245 x 160 x 45	steel sheet varnished assortment box with 6 little, 1 tool partition and following content:	300 x 0,75 - 8	56081
			300 x 1,00 - 8	56002
			300 x 1,50 - 8	56003
			200 x 2,50 - 8	56058
			200 x 4,00 - 10	56061
			100 x 6,00 - 12	56084
			1 x crimping tool	05122
<b>10492</b>	245 x 160 x 45	ditto, but with square crimping tool 05124	1 x square crimping tool	05124
<b>10493</b>	245 x 160 x 45	ditto, but without tool	without tool	
<b>10494</b>	245 x 160 x 45	steel sheet varnished assortment box with 6 little, 1 tool partition and following content:	200 x 2 x 0,50 - 8	57000
			200 x 2 x 0,75 - 8	57001
			200 x 2 x 1,00 - 8	57003
			200 x 2 x 1,50 - 8	57005
			200 x 2 x 2,50 - 10	57007
			200 x 2 x 4,00 - 12	57009
		1 x crimping tool	12646	
<b>10495</b>	245 x 160 x 45	ditto, but without tool	without tool	

Part-No.	dimensions mm	description	content	
<b>10496</b>	350 x 160 x 35	steel sheet varnished assortment box with 7 little, 1 tool partition and following content:	300 x 0,75 - 8	56081
			300 x 1,00 - 8	56002
			300 x 1,50 - 8	56003
			200 x 2,50 - 8	56058
			200 x 4,00 - 10	56061
			100 x 6,00 - 12	56084
			50 x 10,00 - 12	56086
			1 x crimping tool	05122
<b>10497</b>	350 x 160 x 35	ditto, but with square crimping tool 12640	1 x square crimping tool	12640
<b>10498</b>	350 x 160 x 35	ditto, but without tool	without tool	
<b>10499</b>	350 x 160 x 35	steel sheet varnished assortment box with 12 little, 1 tool partition and following content:	100 x 0,75 - 8	56081
			100 x 1,00 - 8	56002
			100 x 1,50 - 8	56003
			100 x 1,50 - 10	56003/1
			100 x 2,50 - 8	56058
			100 x 2,50 - 12	56059
			100 x 4,00 - 10	56061
			50 x 6,00 - 12	56084
			50 x 10,00 - 12	56086
			50 x 10,00 - 18	56087
			50 x 16,00 - 12	56088
50 x 16,00 - 18	56089			
		1 x crimping tool	05122	
<b>10500</b>	350 x 160 x 35	ditto, but without tool	without tool	

## Assortment-boxes with crimping tool and insulated cable end sleeves



Part-No.	dimensions mm	description	content		
05145	235 x 185 x 47	Insulated cable end sleeves in usual trade design in a plastic suitcase with 5 little and 1 tool partition and a handy crimping tool in a cross section range 0,25-6 mm <sup>2</sup> with square crimping	100 x 8 - 0,5	white	56000
			100 x 8 - 0,75	blue	56001
			100 x 8 - 1	red	56002
			100 x 8 - 1,5	black	56003
			100 x 8 - 2,5	grey	56006
			1 x crimping tool		05141
05146	235 x 185 x 47	Insulated cable end sleeves in usual trade design in a plastic suitcase with 5 little and 1 tool partition and a handy crimping tool in a cross section range 0,25-6 mm <sup>2</sup> with square crimping	100 x 8 - 0,5	orange	56045
			100 x 8 - 0,75	white	56048
			100 x 8 - 1	yellow	56052
			100 x 8 - 1,5	red	56055
			100 x 8 - 2,5	black	56058
			1 x crimping tool		05141
05147	235 x 185 x 47	Insulated cable end sleeves in usual trade design in a plastic suitcase with 5 little and 1 tool partition and a handy crimping tool in a cross section range 0,25-6 mm <sup>2</sup> with square crimping	100 x 8 - 0,5	white	56000
			100 x 8 - 0,75	grey	56081
			100 x 8 - 1	red	56002
			100 x 8 - 1,5	black	56003
			100 x 8 - 2,5	blue	56058
			1 x crimping tool		05141
05148	235 x 185 x 47	Insulated cable end sleeves in usual trade design in a plastic suitcase with 5 little and 1 tool partition and a handy crimping tool in a cross section range 0,25-6 mm <sup>2</sup> with square crimping	100 x 8 - 0,5	white	56000
			100 x 8 - 1,5	black	56003
			100 x 8 - 2,5	grey	56006
			50 x 10 - 4	orange	56008
			40 x 12 - 6	green	56010
			1 x crimping tool		05141
05149	235 x 185 x 47	Insulated cable end sleeves in usual trade design in a plastic suitcase with 5 little and 1 tool partition and a handy crimping tool in a cross section range 0,25-6 mm <sup>2</sup> with square crimping	100 x 8 - 0,5	orange	56045
			100 x 8 - 1,5	red	56055
			100 x 8 - 2,5	blue	56058
			50 x 10 - 4	grau	56061
			40 x 12 - 6	black	56064
			1 x crimping tool		05141
05150	235 x 185 x 47	Insulated cable end sleeves in usual trade design in a plastic suitcase with 5 little and 1 tool partition and a handy crimping tool in a cross section range 0,25-6 mm <sup>2</sup> with square crimping	100 x 8 - 0,5	white	56000
			100 x 8 - 1,5	black	56003
			100 x 8 - 2,5	blue	56058
			50 x 10 - 4	grey	56051
			40 x 12 - 6	yellow	56084
			1 x crimping tool		05141
05151	235 x 185 x 47	Insulated cable end sleeves in usual trade design in a plastic suitcase with 5 little and 1 tool partition and a handy crimping tool in a cross section range 0,25-6 mm <sup>2</sup> with square crimping	100 x 2 x 0,5	white	57000
			100 x 2 x 0,75	grey	57001
			100 x 2 x 1	red	57003
			75 x 2 x 1,5	black	57005
			50 x 2 x 2,5	blue	57007
			1 x crimping tool		05141

# 1. ELECTRICAL CONNECTION- AND INSTALLATION TECHNIQUE

## 1.10 Crimp- and plug connectors as well as insulating sleeves and terminal blocks

Function of crimp- and plug connectors is to realize an electrical connection which can be separated and reconstituted again. Also in this product field druseidt offers a wide range of DIN-certified as well as products in special design. Such products are complemented by the delivering of different terminal blocks, insulating sleeves and housings.

The uninsulated tabs and receptacles consisting out of brass are suitable for the following temperature range: uncoated up to + 90° C, tin-plated up to + 100° C, silver-plated up to + 110° C, connectors consisting out of nickel-plated steel up to + 250° C. The crimping operations are carried out with special dies for uninsulated open barrel terminals which realize the contact and insulation crimping in one step. To guarantee a perfect and corrosion resistant crimp-connection it is important to pay attention of the right tool selecting. Recommended crimping tools as well as detailed technical information are contained on catalogue pages 154-157 resp. inside of the technical appendix.

Please notice, that all crimping operations will be done only with the right tools resp. suitable compression dies.

Crimping design:  
Double crimp  
for open barrel terminals





## Receptacles 2,8 mm

Material: brass

Surface: uncoated or tinned

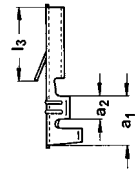
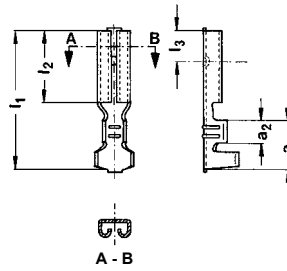

04347 vz with tabs

Part-No.		cross-section mm <sup>2</sup>	tab-thickness mm	DIN-size	dimensions mm					locking point	weight kg/% pcs.	crimping-tools/page no.
uncoated	tinned				L <sub>1</sub>	L <sub>2</sub>	L <sub>3</sub>	a <sub>1</sub>	a <sub>2</sub>			
<b>design DIN 46247 part 1</b>												
-	04351 vz	0,1 - 0,25	0,8	-	14	6,3	3,3	5	2	x	0,20	
04360	04360 vz	0,5 - 1	0,5	A 2,8-1				5,5	2,5	x	0,23	
04361	04361 vz	0,5 - 1	0,8	B 2,8-1				5,5	2,5	x	0,23	
<b>design DIN 46330 part 2 design A</b>												
-	04356 vz	0,5 - 1	0,5	-	12,5	5	3,3	5	2,8	x	0,25	
-	04358 vz	0,5 - 1	0,8	A 2,8-1				5,5	2,5	x	0,25	
<b>design DIN 46340 part 1 with tabs</b>												
-	04347 vz	0,5 - 1	0,5	A 2,8-1	14	6,3	5,6	5,5	2,5	-	0,24	

pages no.  
153, 155-159

## Tab connectors 2,8 mm

Material: brass

Surface: tinned

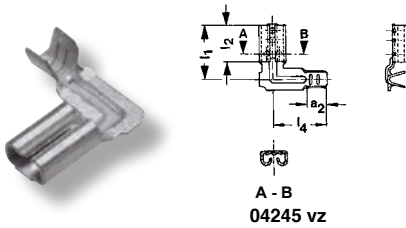

04245 vz

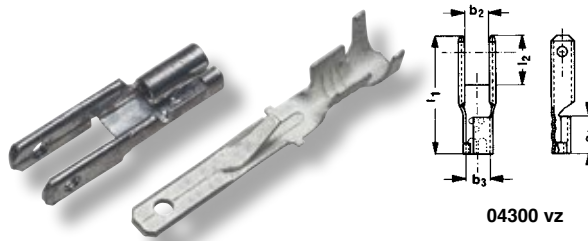

04300 vz

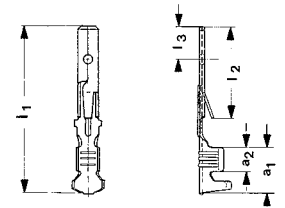

04305 vz

Part-No.		cross-section mm <sup>2</sup>	tab-thickness mm	dimensions mm								weight kg/% pcs.	crimping-tools/page no.
tinned				L <sub>1</sub>	L <sub>2</sub>	L <sub>3</sub>	L <sub>4</sub>	a <sub>1</sub>	a <sub>2</sub>	b <sub>2</sub>	b <sub>3</sub>		
<b>Flat tab receptacles in flag type design</b>													
04245 vz		0,5 - 1	0,5	9,35	5	-	7,2	-	2,5	-	-	0,27	
<b>Multiple tabs</b>													
04300 vz		-	0,8	16	6,7	-	-	5	-	3,2	3,1	0,56	
<b>Flat tab connector with additional tab to engage in housings</b>													
04305 vz		0,5 - 1	0,8	22,5	12,7	2,2	-	6	3,2	-	-	0,42	

pages no.  
153, 155-159

## Tabs 2,8 mm

for soldering into PC-boards

Material: brass

Surface: tinned

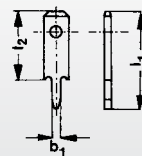

Part-No.	tab-thickness mm	b <sub>1</sub>	dimensions mm		weight kg/% pcs.
tinned			L <sub>1</sub>	L <sub>2</sub>	
04428 vz	0,8	0,9	10,5	6,5	0,14

### Receptacles 4,8 mm

Material: brass  
Surface: uncoated or tinned

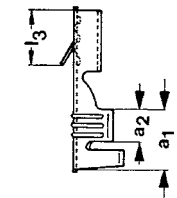
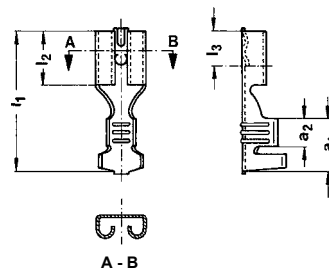

04296 vz with add. tab to engage in housings

Part-No.		cross-section mm <sup>2</sup>	tab-thickness mm	DIN-size	dimensions mm					locking point	weight kg/‰ pcs.	crimping-tools/page no.
uncoated	tinned				L <sub>1</sub>	L <sub>2</sub>	L <sub>3</sub>	a <sub>1</sub>	a <sub>2</sub>			
<b>design DIN 46247 part 2</b>												
04285	04285 vz	0,5 - 1	0,5	-	15,6	6	3,8	6	3,4	x	0,50	pages no. 153, 155-159
04287	04287 vz		0,8	4,8 - 1						x	0,50	
-	04292 vz	1,5 - 2,5	0,8	4,8 - 2,5						x	0,54	
<b>design with tabs to engage in housings</b>												
-	04296 vz	0,5 - 1	0,8	-	15,8	6	5,5	6	3,4	-	0,50	

### Multiple receptacles 4,8 mm

Material: brass  
Surface: tinned

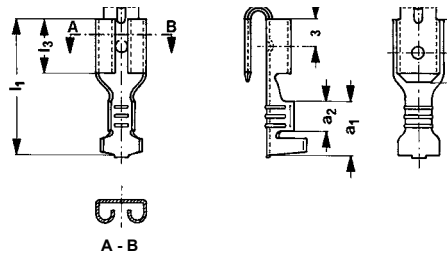

Part-No.	cross-section mm <sup>2</sup>	tab-thickness mm	dimensions mm					locking point	weight kg/‰ pcs.	crimping-tools/page no.
tinned			L1	L2	L3	a1	a2			
11720 vz	0,5 - 1	0,8	15,6	7	6	6	3,4	x	0,68	pages no.
11725 vz	1,5 - 2,5	0,8	15,6	7	6	6	3,4	x	0,70	153, 155-159

### Tabs 4,8 mm

Material: brass  
Surface: tinned



04332 vz

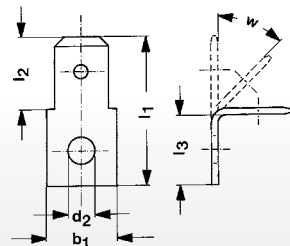

04340 vz

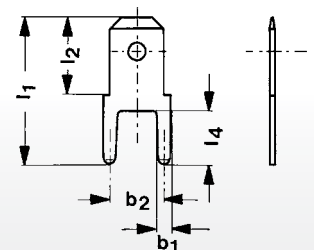

Part-No.	tab-thickness mm	dimensions mm								weight kg/‰ pcs.
tinned		b <sub>1</sub>	b <sub>2</sub>	d <sub>2</sub>	L <sub>1</sub>	L <sub>2</sub>	L <sub>3</sub>	L <sub>4</sub>	w	
<b>for screwing</b>										
04332 vz	0,8	6,5	-	4,3	17,5	7	7,5	-	45°	0,60
<b>for soldering into PC-boards</b>										
04340 vz	0,8	1,2	5	-	13,5	7	-	5	-	0,38

### Receptacles 6,3 mm

DIN 46247 part 3 with locking point  
 Material: brass or steel  
 Surface: uncoated, tinned or nickel plated

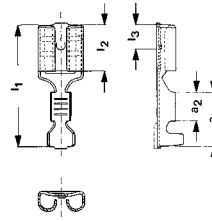

brass uncoated	Part-No.		cross-section mm <sup>2</sup>	tab-thickness mm	DIN-size	dimensions mm					weight kg/‰ pcs.	crimping-tools/page no.
	brass tinned	steel nickel plated				L <sub>1</sub>	L <sub>2</sub>	L <sub>3</sub>	a <sub>1</sub>	a <sub>2</sub>		
04870	04870 vz	04872	0,5 - 1	0,8	6,3 - 1	19,2	7,4	4	8,5	4,5	0,75	pages no. 153, 155-159
04875	04875 vz	04877	0,75 - 1,5		-						0,89	
04878	04878 vz	04880	1,5 - 2,5		6,3 - 2,5						0,92	
04883	04883 vz	04885	4 - 6		6,3 - 6						0,98	

### Receptacles 6,3 mm

DIN 46340 part 3 with tabs to engage into housings  
 Material: brass  
 Surface: uncoated or tinned

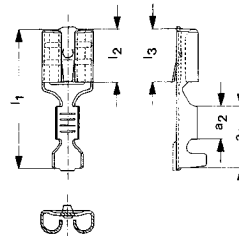
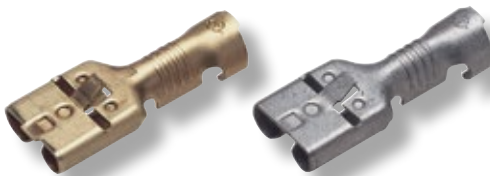

uncoated	Part-No.		cross-section mm <sup>2</sup>	tab-thickness mm	DIN-size	dimensions mm					weight kg/‰ pcs.	crimping-tools/page no.
	tinned					L <sub>1</sub>	L <sub>2</sub>	L <sub>3</sub>	a <sub>1</sub>	a <sub>2</sub>		
04886	04886 vz		0,5 - 1	0,8	A 6,3 - 1	19,2	7,4	7	8,5	4,5	0,70	pages no. 153, 155-159
04888	04888 vz		1,5 - 2,5		A 6,3 - 2,5						0,78	
04890	04890 vz		4 - 6		A 6,3 - 6						0,88	
04892	04892 vz		0,5 - 1	0,8	B 6,3 - 1	19,2	7,4	7	8,5	4,5	0,70	
04894	04894 vz		1,5 - 2,5		B 6,3 - 2,5						0,78	
04896	04896 vz		4 - 6		B 6,3 - 6						0,88	

DIN type B Part-No. 04892-96 with additional locking point

### Receptacles 6,3 mm

DIN 46346 part 3 design A + B  
 Flag type  
 Material: brass  
 Surface: uncoated or tinned

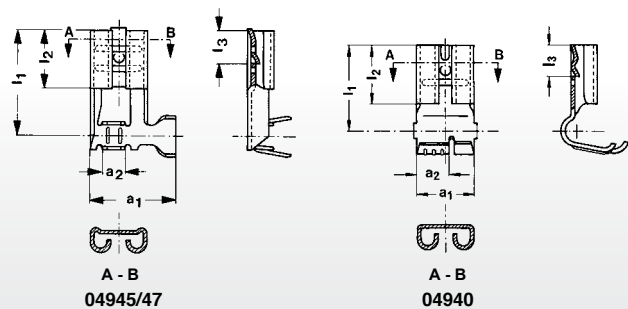

uncoated	Part-No.		cross-section mm <sup>2</sup>	tab-thickness mm	DIN-size	dimensions mm					locking point	weight kg/‰ pcs.	crimping-tools/page no.
	tinned					L <sub>1</sub>	L <sub>2</sub>	L <sub>3</sub>	a <sub>1</sub>	a <sub>2</sub>			
04945	04945 vz		0,5 - 1	0,8	A 6,3 - 1	12,5	7,4	4	11	3,5	x	0,81	30480 page no. 155
04947	04947 vz		1,5 - 2,5		A 6,3 - 2,5	13,85					x	0,84	on request
04940	04940 vz		0,5 - 1,5	0,8	B 6,3 - 1,5	11	7,4	4	7,5	4	x	0,84	30481 page no. 155

### Multiple tabs 6,3 mm

Dimensions in the tab sector DIN 46244 part 1

Material: brass

Surface: uncoated or tinned

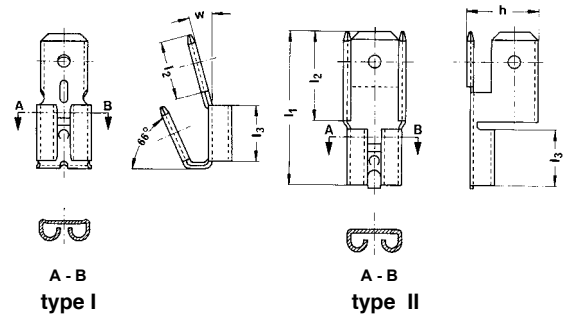

Part-No.		type	tab-thickness mm	dimensions mm					locking point	weight kg/‰ pcs.
uncoated	tinned			L1	L2	L3	h	w		
04585*	04585 vz*	I	0,8	-	8	7,5	-	15°	-	1,14
04588	-	II		20,5	12	7,4	9,6	-	x	1,85

Part.-No. 04585/04585 vz = design in accordance with DIN 46347

### Multiple tabs 6,3 mm

DIN 46345 part 1

Material: brass

Surface: uncoated or tinned

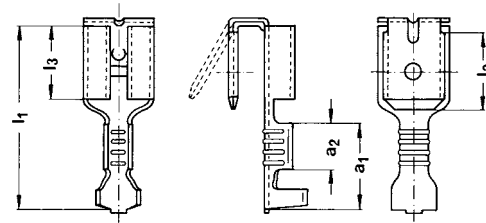
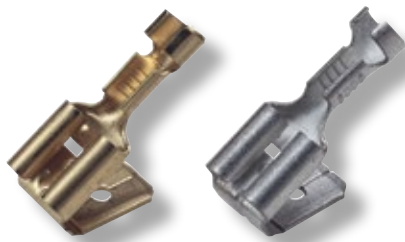

Part-No.		cross-section mm <sup>2</sup>	tab-thickness mm	DIN-size	dimensions mm						weight kg/‰ pcs.	crimping-tools/page no.
uncoated	tinned				L <sub>1</sub>	L <sub>2</sub>	L <sub>3</sub>	a <sub>1</sub>	a <sub>2</sub>	w		
04605	04605 vz	0,5 - 1	0,8	6,3 - 1	20	8	7,4	8,8	4,7	30°	1,12	pages no. 153, 155-159
04607	04607 vz	1,5 - 2,5		6,3 - 2,5							1,14	

### Receptacles 6,3 mm

Material: brass

Surface: tinned

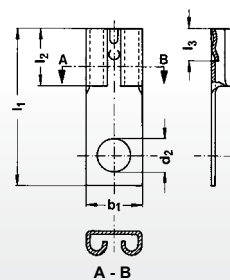

Part-No.	tab-thickness mm	d <sub>2</sub>	L <sub>1</sub>	dimensions mm				b <sub>1</sub>	locking point	weight kg/‰ pcs.
				L <sub>2</sub>	L <sub>3</sub>	L <sub>4</sub>				
04980 vz	0,8	3,1	20,5	7,5	4	-	7,5	x	0,84	
04982 vz		4,3						x	0,83	



**Tabs 6,3 mm**

DIN 46248 part 3, design A

Material: brass

Surface: tinned

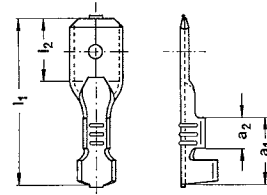

Part-No.	cross-section mm <sup>2</sup>	tab-thickness mm	DIN-size	dimensions mm				weight kg/‰ pcs.	crimping-tools/page no.
				L <sub>1</sub>	L <sub>2</sub>	a <sub>1</sub>	a <sub>2</sub>		
04790 vz	0,5 - 1	0,8	A 6,3 - 1	20	8,8	8,5	4,6	0,58	pages no. 153, 155-159
04792 vz	1,5 - 2,5		A 6,3 - 2,5					0,66	

**Tabs 6,3 mm**

with tabs to engage into housings

Material: brass

Surface: tinned

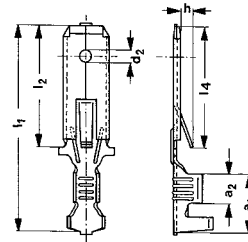

Part-No.	cross-section mm <sup>2</sup>	tab-thickness mm	dimensions mm							weight kg/‰ pcs.	crimping-tools/page no.
			d <sub>2</sub>	L <sub>1</sub>	L <sub>2</sub>	L <sub>4</sub>	a <sub>1</sub>	a <sub>2</sub>	h		
04801 vz	0,5 - 1	0,8	-	28	16	15,5	8,2	4	2,6	0,83	pages no. 153, 155-159
04802 vz	1,5 - 2,5		1,65							0,92	
04804 vz	4 - 6		1,65							1,01	

**Tabs 6,3 mm**

for welding connection

Dimensions in the tab sector DIN 46244 part 1

Material: steel

Surface: nickel plated

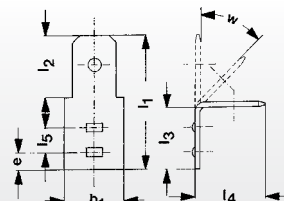

Part-No.	tab-thickness mm	dimensions mm										weight kg/‰ pcs.
		L <sub>1</sub>	L <sub>2</sub>	L <sub>3</sub>	L <sub>4</sub>	L <sub>5</sub>	b <sub>1</sub>	b <sub>2</sub>	e	h	w	
04538	0,8	19	8	9,5	9,5	3,5	8	6	2,5	-	45°	0,89
04540				7,7	10,3						90°	0,89

**Tabs 6,3 mm**

Dimensions in the tab sector DIN 46244 part 1

Material: brass

Surface: uncoated or tinned

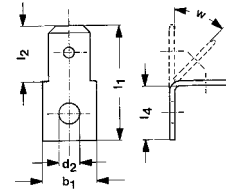

uncoated	Part-No.		type	tab-thickness mm	dimensions mm					weight kg/‰ pcs.	
		tinned			d <sub>2</sub>	L <sub>1</sub>	L <sub>2</sub>	L <sub>4</sub>	b <sub>1</sub>		w
-	04686*		I	0,8	-	19	8	-	8	-	0,91
-	04630 vz**				4,3			-		-	0,86
-	04632 vz				5,3			-		-	0,80
-	04637 vz		II	0,8	3,2	19	8	8	8	45°	0,85
-	04645 vz				4,1				8		0,85
-	04651 vz**				4,3				8,5		0,85
04660	04660 vz				5,3				8		0,80

\* Part-No. 04686 = material steel nickel plated

\*\* Part-No. 04630 vz und 04651 vz = design nach DIN 46342 Teil 1 design A+B

**Tabs 6,3 mm**

Dimensions in the tab sector DIN 46244 part 1

Material: brass

Surface: tinned

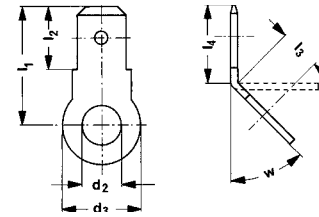

Part-No.	tab-thickness mm	d <sub>2</sub>	d <sub>3</sub>	dimensions mm					w	weight kg/‰ pcs.
04707 vz	0,8	6,3	17	18,5	8	8,5	10	45°	1,70	
04710 vz		8,4							1,58	
04711 vz		10,5							1,33	

**Tabs 6,3 mm**

Dimensions in the tab sector DIN 46244 part 1

Material: brass or steel

Surface: tinned or nickel plated

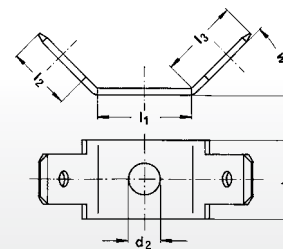

Part-No.	tab-thickness mm	d <sub>2</sub>	L <sub>1</sub>	dimensions mm				b <sub>1</sub>	w	weight kg/‰ pcs.
04515 vz	0,8	4,3	12	8	9,95	-	10	45°	1,60	
04518 vz		5,2				-			1,53	
11915*	0,8	4,2	12	8	9,95	8	10	45°	1,49	

\* Part-No. 11915 = material steel nickel plated

### Tabs 6,3 mm

Dimensions in the tab sector DIN 46244 part 1

Material: brass or steel

Surface: tinned or nickel plated

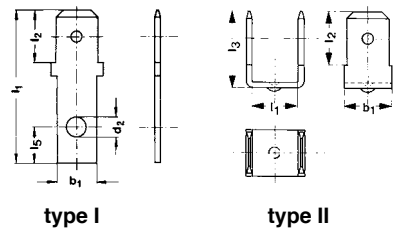
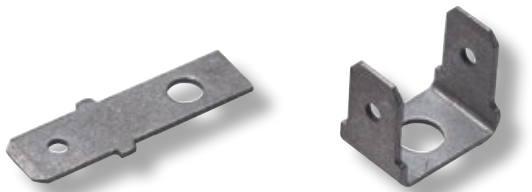

Part-No. tinned	type	tab-thickness mm	dimensions mm						weight kg/‰ pcs.
			d <sub>2</sub>	L <sub>1</sub>	L <sub>2</sub>	L <sub>3</sub>	L <sub>5</sub>	b <sub>1</sub>	
04850 vz	I	0,8	3,1	23,2	8	5,5	5,5	6	0,92
04527*	II	-	-	7,2	8	11,5	-	7	1,30

\* Part-No. 04527 material steel nickel plated, with weld point instead of drilling (contrary to photo)

### Tabs 6,3 mm

for soldering into PC boards

Dimensions in the tab sector DIN 46244 part 1

Material: brass S

Surface: tinned

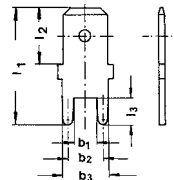

Part-No. tinned	tab-thickness mm	dimensions mm						weight kg/‰ pcs.
		L <sub>1</sub>	L <sub>2</sub>	L <sub>3</sub>	b <sub>1</sub>	b <sub>2</sub>	b <sub>3</sub>	
04721 vz	0,8	16,5	8	4	3,5	5	6,4	0,65

### Ring terminals 0,5-6 mm<sup>2</sup>

in acc. with DIN 46225 design A

Material: brass

Surface: uncoated or tinned

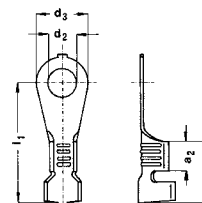

Part-No. uncoated	Part-No. tinned	cross-section mm <sup>2</sup>	DIN Größe	dimensions mm					weight kg/‰ pcs.	crimping-tools/page no.
				a <sub>1</sub>	a <sub>2</sub>	d <sub>2</sub>	d <sub>3</sub>	L <sub>1</sub>		
04058	04058 vz	0,5 - 1	A4 - 1	9	4,5	4,3	8	17	0,73	12230 page no. 156/157
04060	04060 vz		A5 - 1			5,3	9,5	17,5	0,73	
04063	04063 vz		A6 - 1			6,5	12	22	1,00	
04070	04070 vz	1,5 - 2,5	A4 - 2,5	9	4,5	4,3	8	18,3	0,85	
04072	04072 vz		A5 - 2,5			5,3	9,5	17,5	0,87	
04074	04074 vz		A6 - 2,5			6,5	12	22	1,10	
-	04076 vz		A8 - 2,5			8,4	14	21	1,15	
-	04080 vz	4 - 6	A4 - 6	11	4,5	4,3	8	21,3	1,70	
-	04083 vz		A5 - 6			5,3	9,5	20,5	2,15	
-	04085 vz		A6 - 6			6,5	12	25	2,10	

### Insulating sleeves 2,8/4,8/6,3 mm for tabs and receptacles

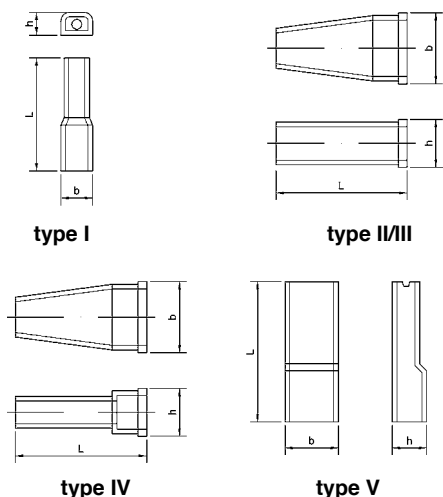

Part-No.	type	application	cable-Ø max. mm	dimensions mm			material
				L	b	h	
03696	I	receptacles 2,8 mm	2,5	19,5	5,5	3,5	PE
03697			2,8				soft PVC
03699	II	receptacles 4,8 mm	3,2	21	8	4,5	PE
03703	III	receptacles 6,3 mm	3,2	25	9,5	5	PE
03707	IV	tabs 6,3 mm	3,2	23	12,5	8,5	PE
03708	V	receptacles 6,3 mm	3,6	24	9,3	8	PA

Nature colour is standard. Other colours on request. By using a combination of type III and IV you get a fully insulated connection consisting of receptacle and tab. Part-No. 03708 suitable for application after crimping.

### Insulation sleeves 6,3 mm for flag type receptacles

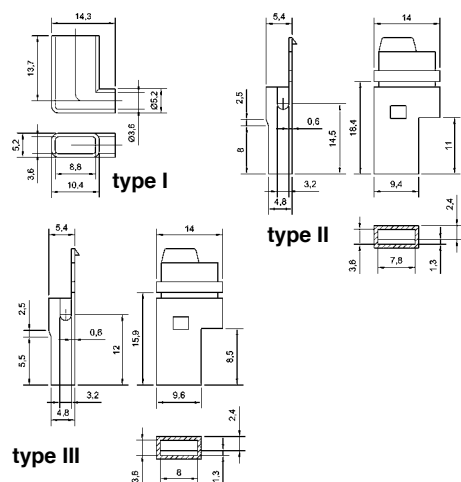

Part-No.	type	application	cable-Ø max. mm	material	colour
03709	I	receptacles flag type 6,3 mm	3,6	soft PVC	black
03710	II		3,2	PE	nature
03711	III		3,2	PE	nature

By using part-no. 03710/03711 it's possible to mount them after crimping.

### Housings/Couplings

for tabs and receptacles 6,3 mm

Material: PA nature, self-extinguishing to UL 94, V-2

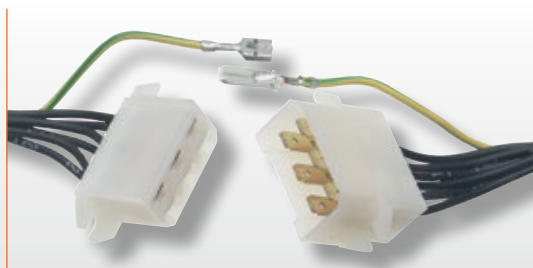

Part-No.	pole-no.	application	rated voltage	length mm	width mm	height mm	weight kg/% pcs.
03715	2	tab part	400 V	13	15,2	32	0,25
03716	2	receptacle part		19	13	19	0,17
03717	4	tab part	400 V	28	17	32	0,38
03718	4	receptacle part		35,8	15,5	24	0,40
03719	6	tab part	400 V	48	19	32	0,65
03720	6	receptacle part		48	17,5	24	0,56
03721	8	tab part	400 V	49	25	32	0,74
03722	8	receptacle part		37,5	16,2	24	0,57

Rated voltage in accordance with DIN VDE 0110 pollution degree 2. Tabs and receptacles are arrested by their index lobes. The form of the case makes it impossible to plug the two halves together incorrectly. The pole identifiers are located on the plug openings for the metal parts.



**Tab-connectors**

Moulding: PVC/PA

Tabs: brass, tin or nickel plated

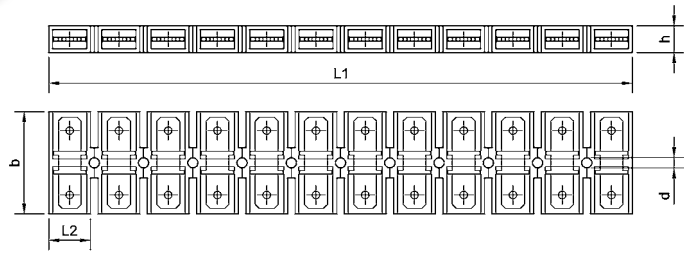

Part-No.	tab connection mm	pole-no.	material	dimensions mm					weight kg/% pcs.
				b	h	L <sub>1</sub>	L <sub>2</sub>	d	
03750	2,8 x 0,8	1	PVC	35	5,5	7,5	-	2,8	0,20
03751		12				88	7,5		1,60
03752	4,8 x 0,8	1	PVC	28	7	12	-	3,2	0,25
03753		12				142	12		2,80
03754	6,3 x 0,8	1	PVC	28	7	12	-	3,2	0,30
03755		12				142	12		3,20
03756	2 x 2,8 x 0,8/	1	PA	46	7,5	10	-	3,1	0,25
03757	1 x 6,3 x 0,8	12				147,5	12,5		2,85

By using connectors 03750/51 and 03756/57 the receptacles are fully insulated. Part-No. 03756/57 offer the possibility to use 4 receptacles 2,8 x 0,8 mm or 2 receptacles 6,3 x 0,8 mm on each pole. It's possible to cut the 12-pole connectors. Rated current 2,8 mm = 6 A, 4,8 mm = 16 A, 6,3 mm = 25 A. Rated Voltage 03750/51 = 250 V with insulating base acc. to DIN EN 60664-1, pollution degree 2. 03752-57 = 400 V with insulating base acc. to DIN EN 60664-1, pollution degree 3.

**Tab-connectors**

Moulding: PVC

Tabs: brass, nickel coated

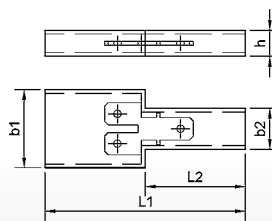
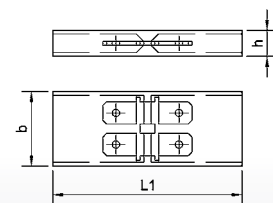
**03764**

**03765**

Part-No.	tab connection mm	pole-no.	cable cross-section	dimensions mm					weight kg/% Stck
				b <sub>1</sub>	b <sub>2</sub>	h	L <sub>1</sub>	L <sub>2</sub>	
03764	1/2 x 6,3 x 0,8	1	up to 6 mm <sup>2</sup>	21	12	7,5	54	27	0,60
03765	2 x 6,3 x 0,8	1	up to 6 mm <sup>2</sup>	20	-	7	51	-	0,65

By using this parts the receptacles are fully insulated. Rated voltage 400 V acc. to DIN EN 60664-1, pollution degree 2.

## Multi-point tab-connectors

Moulding: PC, self extinguishing to UL 94, V-0

Tabs: brass, nickel plated

Cover: PA nature colour

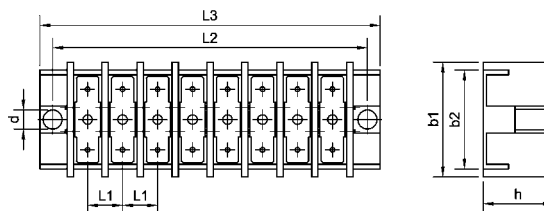
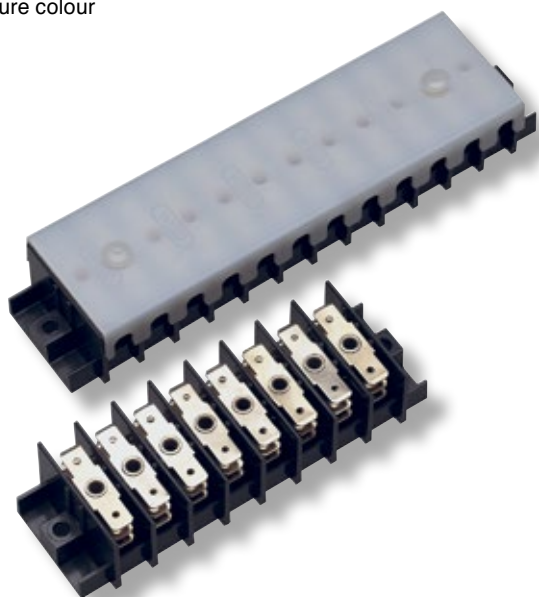

Part-No. tab connector	Part-No. cover	tab connection	pole-no.	dimensions mm							weight kg/% pcs.
				b <sub>1</sub>	b <sub>2</sub>	d	h	L <sub>1</sub>	L <sub>2</sub>	L <sub>3</sub>	
03785	03775	3 x 6,3 x 0,8	3	36	31	4,5	22	11	44	52	3,07
03786	03776		4						55	63	4,06
03787	03777		5						66	74	5,06
03788	03778		6						77	85	6,05
03789	03779		8						99	107	8,03
03790	03780		10						121	129	10,01
03791	03781		12						143	151	11,94
03783	securing pins for covers										

Standard design 1 pole with 6 tabs 6,3 x 0,8 mm in parallel arrangement, other designs or pole numbers on request: Rated voltage by pollution degree 2 over voltage category III = 200 V Rated current max. 25 A

## Tab connectors 2,8 / 6,3 x 0,8 mm

for soldering into PC-boards

Moulding: PA, self extinguishing to UL 94, V-0

Tabs: brass, tinned

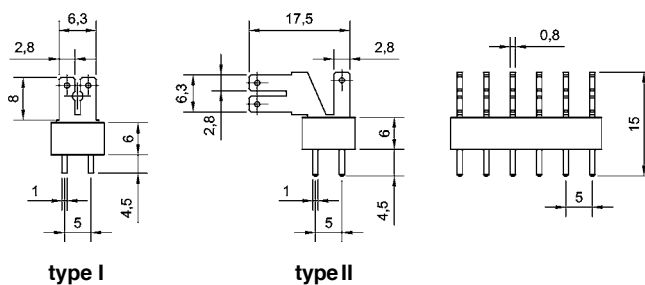
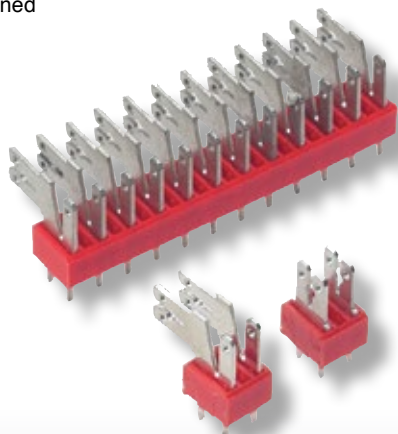

Part-No.	type	pole-no.	rated voltage	length mm	width mm	weight kg/% pcs.
13435	I	2	320/630 V	8,5	9,5	0,15
13436		6		28,5		0,50
13437		12		58,5		0,95
13438	II	2	320/630 V	8,5	9,5	0,22
13439		6		28,5		0,65
13440		12		58,5		1,30

Type I each pole suitable for 2 pcs. uninsulated tabs 2,8 x 0,8 mm or 1 pcs. 6 x 0,8 mm. Type II each pole 1 pcs. uninsulated tabs 2,8 x 0,8 mm and 2 pcs. 2,8 x 0,8 mm or 1 pcs. 6,3 x 0,8 mm. Rated voltage 320 V by pollution degree 2/3 and overvoltage category III, resp. 630 V by pollution degree 2 and overvoltage category II. On request we deliver tab connectors with other pole-no. or with screen 7,5 or 10 mm.

### Plug-in terminal strips with wire protection

Moulding: PA, self-extinguishing to UL 94, V-2

Terminal body: brass, nickel coated

Wire protector: Sn-bronze-tinned

Screws: zinc plated steel, blue passivated

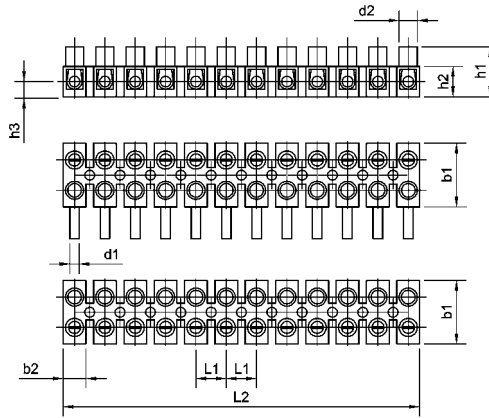
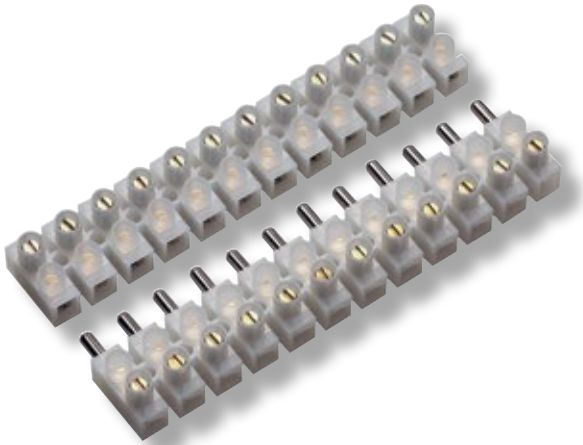

Part-No. plug	Part-No. socket	cross-section range mm <sup>2</sup>	pole-no.	rated-current	dimensions mm								weight kg/% pcs.		
					b <sub>1</sub>	b <sub>2</sub>	h <sub>1</sub>	h <sub>2</sub>	h <sub>3</sub>	d <sub>1</sub>	d <sub>2</sub>	L <sub>1</sub>	L <sub>2</sub>	plug	socket
11990	11995	bis 2,5	2	6 A	16	7,25	12	7	3	2,8	5	8	15	0,50	0,40
11991	11996		3										23	0,70	0,50
11992	11997		4										31	0,90	0,70
11993	11998		6										47	1,40	1,10
11994	11999		12										94	2,70	2,10

Low profile design. Ideal for installations in which simple closing and opening of circuits is necessary (however without voltage applied). It's possible to cut the connectors or to deliver different pole no. on request. Rated voltage 160 V by pollution degree 2/3 and overvoltage category III resp. 320 V by pollution degree 2 and overvoltage category II.

### Socket terminal strips with wire protection

Moulding: PA, self-extinguishing to UL 94, V-2

Terminal body: brass, nickel coated

Wire protector: stainless steel strip

Screws: zinc plated steel, blue passivated

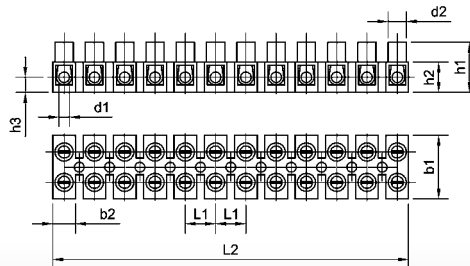
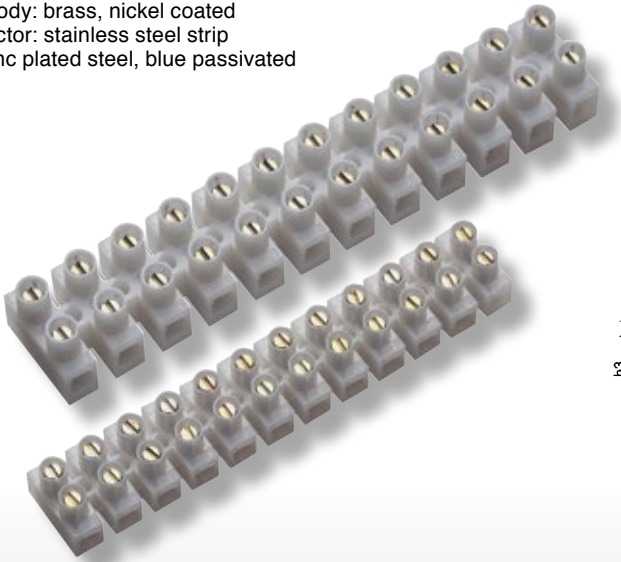

Part-No.	cross-section range mm <sup>2</sup>	pole-no.	rated-current	dimensions mm								weight kg/% pcs.		
				b <sub>1</sub>	b <sub>2</sub>	h <sub>1</sub>	h <sub>2</sub>	h <sub>3</sub>	d <sub>1</sub>	d <sub>2</sub>	L <sub>1</sub>	L <sub>2</sub>		
12002	bis 2,5	1	17,5 A	16	6	12	7	3	2,8	5	-	7	0,20	
12004		12									8	94	2,10	
12010	bis 4	1	24 A	21	6,5	16	9,7	4,9	3,4	6	-	8	0,30	
12011		12									10	117	3,60	
12012	bis 6	1	32 A	22	8	18,5	11,2	5,4	4,1	6,8	-	9	0,40	
12013		12									11,5	135	5,20	

It's possible to cut the 12-pole connectors. On request it is possible to deliver connectors with different pole-no. or designs without wire protection. Rated voltage for the different designs on request.

# 1. ELECTRICAL CONNECTION- AND INSTALLATION TECHNIQUE

## 1.11 Universal conductor terminals, earth- and neutral bars as well as insulators

In this chapter of the catalogue some universal conductor terminals and accessories for switch-box- and plant builders are described. Druseidt delivers clamps for screwless mounting of leadings, supple- and bus-bars as well as different kinds of earthing-bars resp. earthing material or insulators.

More electrical installation material such as machined bus- and supple-bars, bus-bar supports or flexible braided connectors, are listed in our further special catalogues or in the internet under [www.druseidt.de](http://www.druseidt.de)

We offer a wide range of electrical accessories for switching cabinets and similar application. Please ask for our special catalogues.





### Joint clamps 2,5-35 mm<sup>2</sup>

Material: brass  
Surface: uncoated

Part-No.	cross-section mm <sup>2</sup>	size	connecting thread	weight kg/% pcs.
02580	2,5 - 25	M5-25	M5	4,40
02581		M6-25	M6	4,30
02578	4 - 35	M8-35	M8	7,15



### Joint clamps 6-300 mm<sup>2</sup>

Material: brass  
Surface: uncoated

Part-No.	cross-section mm <sup>2</sup>	size	connecting thread	weight kg/% pcs.
02583	6 - 70	M10	M10	18,90
02589	10 - 95	M10-47	M10	33,50
02584		M12	M12	32,90
02587	16 - 150	M12-52	M12	43,10
02585		M16	M16	42,20
02588	16 - 300	M16-60	M16	56,40
02586		M20	M20	55,80



### Screwing connectors 0,6/1 kV

with tin plated brass shear off heads bolts  
Material: high strength aluminium alloy, tinned

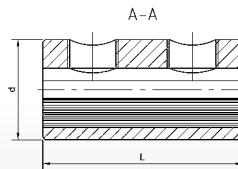

03576

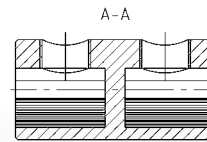

03575

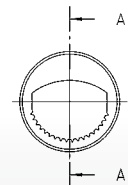

Part-No.	cross-sectional area mm <sup>2</sup>							dimensions mm		screws	weight kg/% pcs.
	aluminium				copper			L	d		
	rm	sm	re	se	rm	sm	re				
03575	25-120	50-120	25-120	25-150	25- 70	25- 95	16-35	70	26,5	M16 x 1	11,70
03576	150-300	150-300	150-300	150-300	150-185	150-185	-	110	38	M22 x 1,5	44,20

Part-No. 03575 with separator.

## Universal conductor terminals 1,5-120 mm<sup>2</sup>

with captive screws

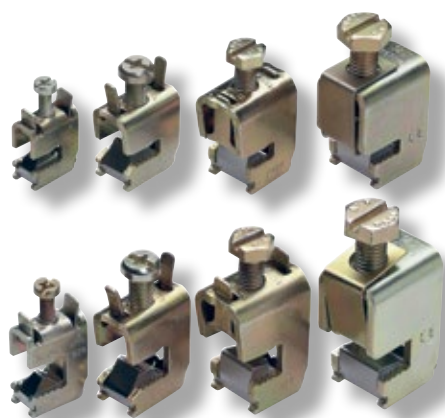

Part-No.	type	cross-section mm <sup>2</sup>	current load max.	compartment B x H mm	weight kg/% pcs.
10545	I	1,5 - 16	180 A	7,5 x 7,5	2,1
10546		4 - 35	270 A	10,5 x 11	4,6
10547		16 - 70	400 A	14 x 14	7,1
10548		16 - 120	440 A	17 x 15	10,8
10549	II	1,5 - 16	180 A	7,5 x 7,5	2,3
10550		4 - 35	270 A	10,5 x 11	4,7
10551		16 - 70	400 A	14 x 14	7,4
10552		16 - 120	440 A	17 x 15	11,0

**Type I:** For bus bar-thickness 5 mm

**Type II:** For bus bar-thickness 10 mm

This universal conductor terminals are suitable for connecting copper conductors to bus bars with thickness 5 or 10 mm without drilling.

## Brace Terminals



Part-No.	type	cross-section mm <sup>2</sup>	for use with		current load max.	compartment B x H	weight kg/% pcs.
			supple-bars mm	massive-bars mm			
10565	I	95 - 185	-	-	500 A	30 x 25 mm	23,7
10566		150 - 300	-	-	600 A	32 x 25 mm	37,1
10568	II	-	5x24x1 bis 10x24x1	30 x 25	750 A	30 x 25 mm	25,0
10569		-	5x24x1 bis 10x32x1	32 x 25	800 A	32 x 25 mm	37,1
10571	III	150 - 300	-	-	630 A	30 x 25 mm	33,6
10572		-	5x24x1 bis 10x24x1	30 x 25	630 A	30 x 25 mm	39,6

**Type I:** For connecting round conductors with bus bars 20 x 5 up to 30 x 10 mm without drilling.

**Type II:** For connecting insulated supple bars and solid bars with bus bars 20 x 5 up to 30 x 10 mm without drilling.

**Type III:** For switch gear connection with latch 30 mm width and drilling M12 and round- or flat connectors.

The jaw type terminals enable the bus bar to be gripped completely and conductors to be connected without drilling. By using aluminium connectors the connection is not maintenance free and must be inspected from time to time.

## Bus bar connectors

Material: St37K, zinc- and chrome plated

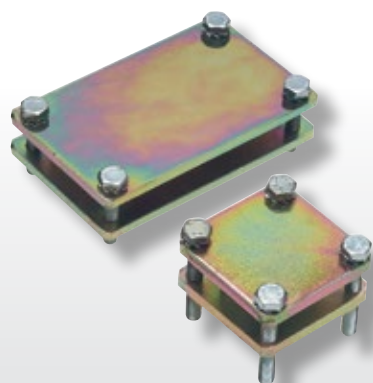

Part-No.	dimensions mm		screws	weight kg/% pcs.
	compartment L x B	external dimensions L <sub>1</sub> x B <sub>1</sub>		
02220	18 x 18	35 x 39	M 6 x 25	11,00
02221	33 x 33	50 x 50	M 6 x 40	22,00
02222	35 x 53	57 x 75	M 6 x 30	29,00
02223	41 x 41	60 x 60	M 6 x 50	32,00
02224	42 x 64	60 x 85	M 6 x 30	36,00
02225	53 x 53	75 x 75	M 6 x 50	50,00
02226	42 x 82	63 x 103	M 6 x 30	45,00
02227	64 x 64	80 x 80	M 6 x 50	54,00
02228	82 x 82	120 x 120	M 10 x 50	139,00
02229	102 x 102	140 x 140	M 12 x 80	320,00

Bus bar connectors for connecting bus bars and supple bars.

## Earth and neutral bus bars

We manufacture and deliver earth and neutral bus bars consisting out of copper or brass with coated as well as uncoated surfaces.

Our standardized delivery program is completed by the manufacturing of designs according to clients wishes or drawings. We deliver up to a length of ca. 4 m with special hole pattern, threads or special coatings.

### Punched E-copper bars in customized design

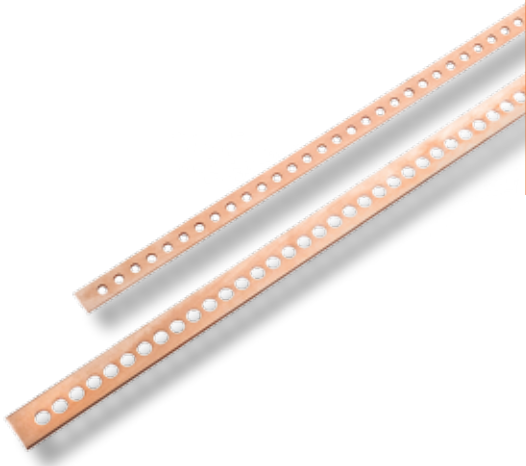

We manufacture punched E-copper bars with and without screw threads beginning in a width from 15 mm and a thickness of 3 mm with coated or uncoated surface. We deliver bars coordinated with your application whether with round or slot holes, or with a hole combination of round and slot holes in different dimensions. Additionally to the delivery of mass produced articles we deliver individual items shortly and to a favourable price.

### Earth and neutral bus bars

with and without screws  
Length: 1000 mm  
Material: brass

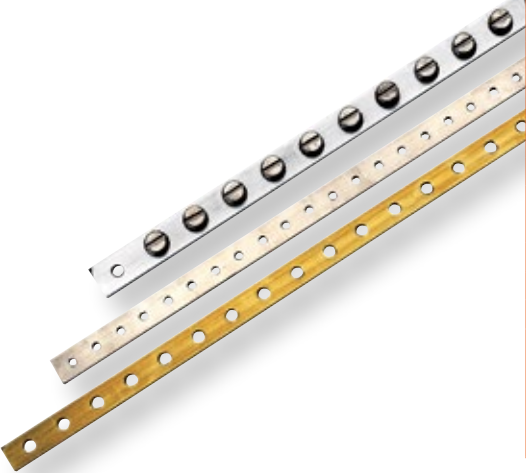

Part-No.				dimensions mm B x S	connections	distance hole to hole	weight kg/% pcs.
type I	type II	type III	type IV				
02700	02715	02730	02745	10 x 2	62 x M 5	16	14,0
02701	02716	02731	02746		90 x M 5	11	12,0
02702	02717	02732	02747	12 x 3	83 x M 4	12	26,0
02703	02718	02733	02748		64 x M 5	15,5	29,0
02704	02719	02734	02749		58 x M 6	17	27,0
02705	02720	02735	02750	15 x 3	105 x M 4	9,5	36,0
02706	02721	02736	02751		86 x M 5	11,5	35,0
02707	02722	02737	02752		50 x M 5	20	37,0
02708	02723	02738	02753		50 x M 6	20	36,0
02709	02724	02739	02754	15 x 4	42 x M 8	24	45,0
02710	02725	02740	02755	25 x 5	31 x M10	34	98,0

Type I = bus bar brass uncoated, without screws  
Type II = bus bar brass nickel uncoated, without screws  
Type III = bus bar brass uncoated, with screws  
Type IV = bus bar brass nickel coated, with screws

Steel-screws DIN 84 not mounted are standard.  
On request it is possible to deliver a mounted design or with screws made out of brass.

### Earth and neutral bus bars

with self locking protection  
rated current 63 A  
Material: brass

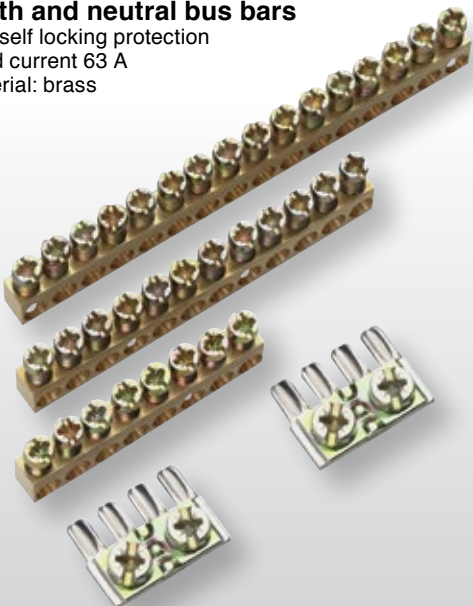

Part-No.	cross-section mm <sup>2</sup>	no. of clamping units	dimensions mm			weight kg/% pcs.
			height	width	length	
10535	10	8	9	6,5	51,5	2,5
10536		12			77,5	3,7
10537		16			103,5	5,8
10538		24			155,0	8,1
10539		151			1000,0	43,0
10541	35	Connection terminal for Part-No. 10535-10539				0,3

## Earth and neutral bus-bars with connection clamps

with self locking protection  
rated current 63 A  
Material: brass tinned

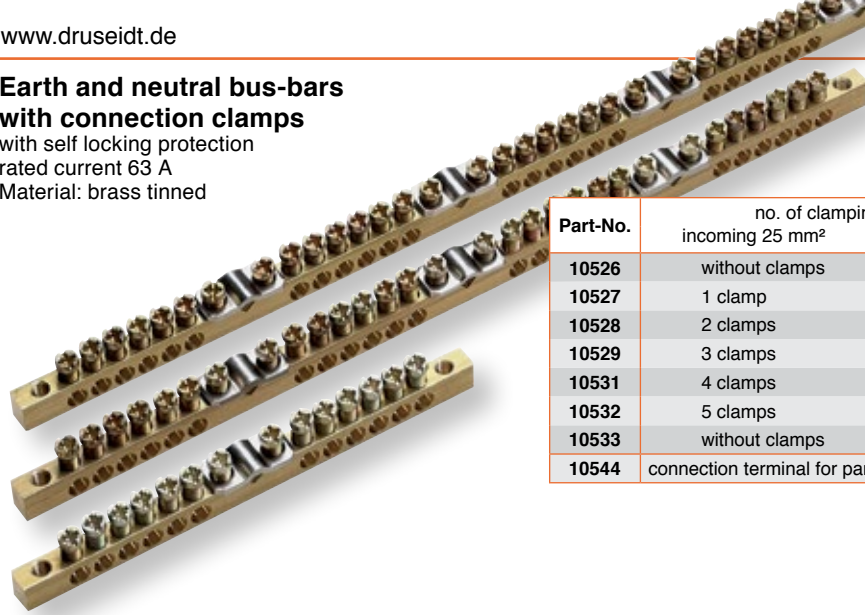

Part-No.	no. of clamping units		dimensions mm			weight kg/% pcs.
	incoming 25 mm <sup>2</sup>	outgoing 10 mm <sup>2</sup>	height	width	length	
10526	without clamps	6	9	6,5	61,5	2,8
10527	1 clamp	12	9	6,5	124,0	6,1
10528	2 clamps	18	9	6,5	186,5	9,4
10529	3 clamps	24	9	6,5	249,0	12,9
10531	4 clamps	30	9	6,5	311,5	16,4
10532	5 clamps	36	9	6,5	374,0	19,4
10533	without clamps	96	9	6,5	1000,0	48,0
10544	connection terminal for part-No. 10533					0,3

## Insulated earth and neutral terminals

rated current 63 A

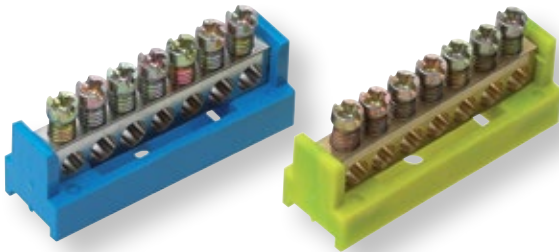

Part-No.	cross-section mm <sup>2</sup>	Klemmstellen	colour	weight kg/% pcs.
For flat bars 12 x 2 mm				
10555	10	7	blue (neutral)	2,8
10556			yellow/green (earth wire)	
For click bars				
10557	10	7	blue (neutral)	2,8
10558			yellow/green (earth wire)	

## Terminal supports

for earth and neutral bus-bars



Part-No.	description	weight kg/% pcs.
02763	Terminal support with movable socket top for bars from 6 x 6 up to 10 x 2 or 15 x 4 mm. Measurement voltage: 500 V AC (VDE 0110 Gr. C).	1,6

## Terminal supports

for earth and neutral bus-bars 9 x 6,5 mm

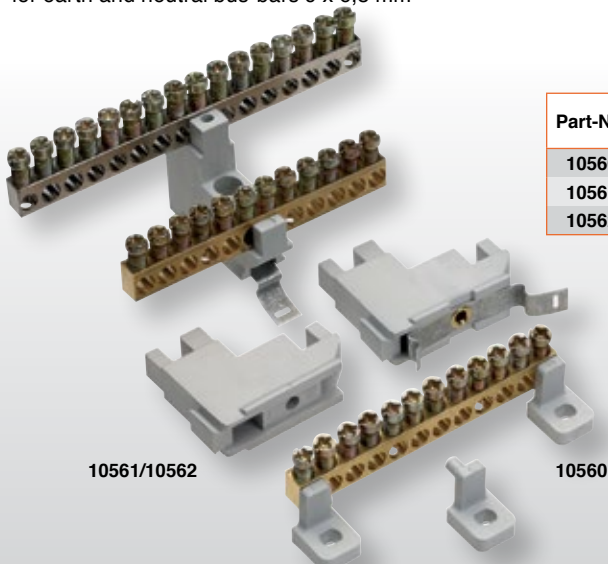

Part-No.	mounting	weight kg/% pcs.
10560	screw connection	0,1
10561	screw connection	0,7
10562	snap connection	0,8

10561/10562

10560



## Standoff insulators made out of polyester resin material

in doubled hexagonal design  
with threaded steel inserts  
for indoor application

The supports described here are made of a glass fibre reinforced unsaturated polyester resin. The special characteristic is a doubled hexagonal design. So a hexagonal area is fixed at the top as well as at the bottom of the insulator. Therefore it is quick and easy to install or remove the insulators even under cramped conditions. This keeps installation costs down to a minimum.

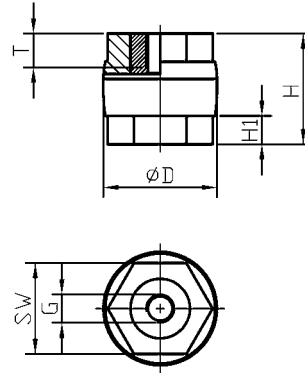

Part-No.	D	H	dimensions mm		T	H <sub>1</sub>	PS/kV	BWS/kV	F/kN	Z/kN	weight kg/% pcs.
			G	SW							
03068 S	30	30	M 6	24	8	9,5	5	0,75	3	6	5,70
03069 S			M 8								5,40
03070 S	30	40	M 6		10	10	5	1,00	4	8	7,30
03071 S	35	30	M 6	30	8	10	5	0,75	4	7	6,50
03072 S			M 8						5	8	6,10
03073 S	40	40	M 8	32	12	10,5	5	1,00	6	11	13,00
03074 S			M 10		11						12,10
03075 S			M 12		10						11,20
03080 S	40	50	M 8	32	12	10,5	10	1,50	5		16,50
13080 S			M 10		15					11	16,50
03081 S			M 12		13				7		13,80
13081 S	40	60	M 8	32	12	11	10	1,50	4		16,90
13082 S			M 10		15					11	17,60
03078 S	50	40	M 10	41	11	13	5	1,00	8		16,50
03079 S			M 12		10				10	13	16,50
13083 S	50	50	M 12	41	13	13,5	10	1,50	8		20,00
03084 S	50	60	M 10		15				6	13	24,10
03085 S			M 12		18				7		24,70
13084 S	60	60	M 12	50	18	18,5	10	1,50	9	15	32,30
13085 S			M 16		17				12	17	32,80

F = rated load on upper insulator edge  
Z = tensile force

PS = testing voltage  
BWS = operating voltage

### Technical data of the material

Density	DIN 53479	1,75 g/cm <sup>3</sup>
Flexural Resistance	DIN 53452/ISO R 178	120 N/mm <sup>2</sup>
Impact Resistance	DIN 53455/ISO R 527	70 N/mm <sup>2</sup>
Impact Value	DIN 53453/ISO R 179	45 KJ/m <sup>2</sup>
Long Term/Operational Temperature	VDE 0304, Teil 21/IEC 216	+ 130 °C
Rod Behaviour	VDE 0304, Teil 3	Stufe BH 2 ≤ 10
Behaviour in case of fire	UL 94	V-0
Surface Resistance	DIN 53482	10 <sup>13</sup> Ω
Throughout Resistance Dielectric	DIN 53482	10 <sup>14</sup> Ω . cm
Loss Factor	DIN 53483	< 0,02 tan /50 Hz
Deposit Tracking	DIN IEC 112/VDE 0303 Teil 1	CT 600
Water Absorption	DIN 53495	< 50 mg/1 d
Colour	-	brown

The values in the table have been determined with our own standards based on DIN 53451 and combined with the standards for the respective materials for test purposes.

## Standoff insulators made out of polyester resin material

with spanner flat  
for indoor application

Standoff insulators manufactures out of a glass fibre reinforced unsaturated polyester resin (UPE). The characteristic of the material is in accordance with DIN Typee 803. The compound is free of halogen with an excellent behaviour in case of fire (UL 94 V-0) and a very good strength of shape.

### Technical data of the material

Strength of shape	ISO 75	> 250 °C
Behaviour in case of fire	UL 94	Class V-0 by 3,2 mm
Density	ISO 1183	1,75 g/cm <sup>3</sup>
Special throughout resistance	IEC 60093	10 <sup>12</sup> Ohm
Dielectric strength	IEC 60243	20 kV/mm
Deposit tracking	IEC 60112	CTI 600
Inserts	steel zinc coated	
Colour	brown	
Temperature range	- 40 °C up to +130 °C	

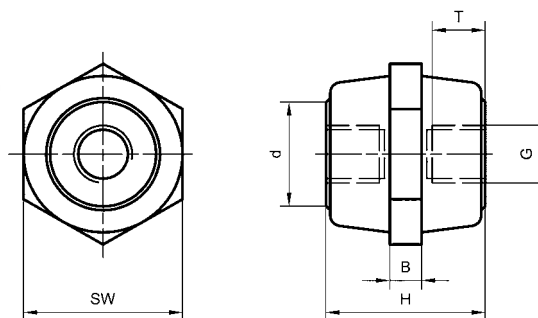

Part-No.	H	SW	dimensions mm		d	B	Md/Nm	F/kN	Z/kN	D/kN	BWS/kV	PWS/kV	weight kg/% pcs.
			G	T									
06135	18	15	M 4	4,5	11	-	3	1,0	2	12	1,0	5	0,70
06138	20	20	M 5	5,5	14	5	5	1,3	3	20	1,0	5	1,20
06139	25	25	M 5	5,5	16	6	15	1,5	3	20	1,0	10	2,40
06140			M 6	8			15	1,5	5	35			2,40
06143	30	30	M 6	8	20	6	20	2,5	6	45	1,0	15	3,80
06144			M 8	10			40	3,0	12	60			5,40
06147	35	30	M 6	8	20	6	20	2,0	6	45	1,0	15	4,50
06148			M 8	10			40	3,5	12	60			6,00
06149			M10	11			50	4,0	16	75			7,00
06150	35	40	M 8	10	28	8	40	4,0	14	70	1,0	15	6,40
06151			M10	11			50	4,5	16	80			7,00
06152	40	30	M 6	8	20	6	20	1,5	6	45	2,0	20	5,00
06153			M 8	10			40	3,0	12	60			6,60
06156	40	40	M 8	10	28	10	50	5,0	14	90	2,0	20	10,00
06157			M10	11			90	8,0	20	100			12,20
06158			M12	12,5			100	10,0	22	120			13,50
06161	40	50	M10	11,5	32	8	120	12,5	23	140	2,0	20	16,00
06162			M12	18			200	12,5	28	180			17,00
06165	50	40	M 8	10	28	10	50	5,0	14	90	3,0	25	12,00
06166			M10	11,5			90	5,0	20	100			14,00
06167			M12	18			100	6,0	22	120			16,00
06170	50	50	M10	11,5	32	10	120	10,0	23	140	3,0	25	20,00
06171			M12	18			200	10,0	28	180			21,50
06174	60	40	M 8	10	28	8	50	4,0	14	90	3,0	25	14,00
06175			M10	11,5			90	6,0	20	100			16,00
06176			M12	18			120	6,0	20	100			18,00
06178	60	50	M10	11,5	32	10	120	9,0	23	140	3,0	25	23,00
06179			M12	18			180	11,0	28	180			25,00
06182	60	60	M12	18	40	10	200	12,0	28	220	3,0	25	33,00
06183			M16	20			300	15,0	32	240			35,00
06184			M20	20			300	16,0	37	240			38,60
06185	80	60	M10	11,5	40	12	200	11,0	32	220	3,0	25	41,00
06186			M12	18			300	15,0	37	240			43,00
06187			M16	21			300	15,0	37	240			45,00

Part No. 06135 Cylindrical design without spanner flat

SW = wrench size

T = usable thread depth

F = rated load limit on upper insulator edge

PWS = testing voltage (AC)

Z = tensile force

D = compressive force

Md/Nm = max. permissible tightening torque

**Standoff insulators made out of Polyamide**

with spanner flat for indoor applications

Standoff insulators manufactured out of reinforced, flame protected and heat stabilized Polyamide. The compound is free of halogen and Phosphor. The material can be converted efficiently and is characterized by his excellent values for tensile strength (Z) and the rated load limit on the upper insulator edge (F). The differences to the design made out of glass fibre reinforced unsaturated polyester resin are basically in the values for the behaviour in case of fire (class V2 to V-0) and the temperature range - 25° C up to + 120° C to - 40° C up to + 130° C.

**technical data**

Behaviour in case of fire	UL 94	Class V2
Density	ISO 1183	1,36 g/cm <sup>3</sup>
Dielectric strength	IEC 60243-1	30 kV/mm
Deposit tracking	IEC 60112	CTI 475
Colour	nature	
Inserts	steel zinc coated	
Temperature range	- 25° C up to + 120° C	



Part-No.	dimensions mm						Md/Nm	F/kN	Z/kN	D/kN	BWS/kV	PWS/kV	weight kg/% pcs.
	H	SW	G	T	d	B							
06100	18	15	M 4	4,5	11	3	3,3	1,0	2	12	1,0	5	0,60
06102	25	25	M 5	5,5	16	6	15	2,0	3,0	20	1,0	10	2,00
06103			M 6	8			15	2,0	5,0	35			2,00
06105	30	30	M 6	8	20	6	20	3,0	6,0	45	1,0	15	3,00
06106			M 8	10			40	4,0	12,0	60			5,00
06109	35	30	M 6	8	20	6	20	5,0	6,0	45	1,0	15	5,00
06110			M 8	10			40	5,0	12,0	60			6,00
06111			M10	11			50	5,0	16,0	75			6,00
06112	35	40	M 8	10	28	8	40	4,0	14,0	70	1,0	15	6,50
06113			M10	11			50	4,5	16,0	80			6,70
06114	40	30	M 6	8	20	6	20	1,5	6,0	45	2,0	20	7,40
06114/8			M 8	10			40	5,0	12,0	60			7,80
06115	40	40	M 8	10	28	8	50	7,0	14,0	90	2,0	20	8,00
06116			M10	14			95	10,0	28,0	100			10,00
06117			M12	12,5			100	12,0	30,0	120			10,00
06120	50	40	M 8	10	28	8	50	5,0	14,0	90	3,0	25	10,00
06121			M10	14			90	5,0	20,0	100			12,00
06122			M12	18			100	6,0	22,0	120			14,00
06125	50	50	M10	14	38	10	120	10,0	23,0	140	3,0	25	18,00
06126			M12	18			160	14,0	28,0	180			19,50
06129	60	40	M 8	10	28	8	50	4,0	14,0	90	3,0	25	12,00
06130			M10	14			90	6,0	20,0	100			14,00
06131			M12	18			120	6,0	20,0	100			14,80

SW = wrench size

T = usable thread depth

F = rated load limit on upper insulator edge

PWS = testing voltage (AC)

Z = tensile force

D = compressive force

Md/Nm = max. permissible tightening torque

# 1. ELECTRICAL CONNECTION- AND INSTALLATION TECHNIQUE

## 1.12 High current plugs and sockets

For ambitious application in the field of high current transfer druseidt offers different possibilities for pluggable solutions. Pluggable high current connectors are dividable electrical connecting elements. When using such elements it is not allowed to make the insertion/withdrawal operation under load or voltage. All insertion/withdrawal operations must be done in the no load state. The current transfer take place by a beryllium disc, which allows to transfer relative high current by working with smaller components.

Additionally to the described components in standard design we deliver and construct various kinds of customized solutions, coordinated with the individual application. Our engineering department would be glad to support your efforts in finding optimized solutions also for application in the range of some thousand amps.

Solderless crimped pluggable connections





**Sockets 35-1500 A**

with thread connection

Material: brass silver plated

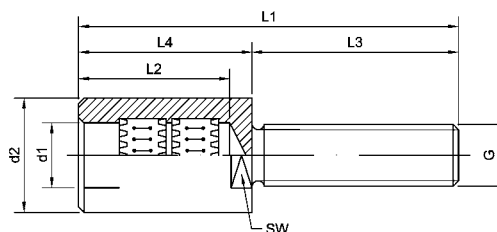

Part-No.	rated-current	dimensions mm									weight kg/% pcs.
		d <sub>1</sub>	d <sub>2</sub>	L <sub>1</sub>	L <sub>2</sub>	L <sub>3</sub>	L <sub>4</sub>	Sw	G		
23810	35 A	2	5,5	36	16,5	16	20	4	M 3	0,40	
23811	40 A	3	6	40	16,5	20	20	5	M 4	0,50	
23812	65 A	4	7	50	19,5	25	25	6	M 5	0,90	
23813	70 A	5	8,5	50	19,5	25	25	7	M 5	1,10	
23814	100 A	6	10	53	19,5	28	25	8	M 6	1,50	
23815	130 A	8	14	78	34	36	42	11	M 8	4,70	
23816	200 A	10	16	84	34	42	42	13	M10	6,60	
23817	230 A	12	18	90	34	48	42	13	M12	8,70	
23818	300 A	14	20	98	38	50	48	17	M14	12,10	
23819	350 A	16	22	106	38	58	48	19	M16	16,00	
23820	400 A	18	25	110	42	58	52	22	M16	19,30	
23821	500 A	20	28	122	42	70	52	24	M18	26,50	
23822	700 A	25	38	149	62	74	75	32	M20	58,80	
23823	900 A	30	42	156	62	81	75	36	M24 x 2	72,60	
23824	1200 A	35	48	165	62	90	75	41	M30 x 2	105,70	
23825	1500 A	40	52	180	62	105	75	46	M36 x 3	140,00	

Sockets without snap-in lock. Suitable to screw into cable lugs, bus-bars, contact blocks or as socket to built into insulated housings for the slide-in rack technology. The amperages were measured at + 20° C ambient temperature and an end temperature of max. + 80° C.

**Plugs 35-1500 A**

with thread connection

Material: brass silver plated

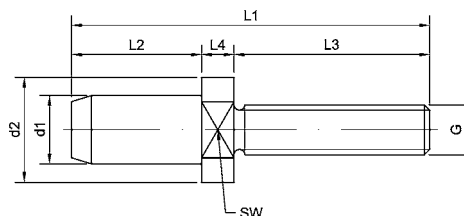

Part-No.	rated-current	dimensions mm									weight kg/% pcs.
		d <sub>1</sub>	d <sub>2</sub>	L <sub>1</sub>	L <sub>2</sub>	L <sub>3</sub>	L <sub>4</sub>	Sw	G		
23830	35 A	2	-	35,5	16,5	16	3	4	M3	0,20	
23831	40 A	3	-	40	16,5	20	3,5	5	M4	0,30	
23832	65 A	4	-	48,5	19,5	25	4	6	M5	0,60	
23833	70 A	5	-	48,5	19,5	25	4	7	M5	0,80	
23834	100 A	6	-	51,5	19,5	28	4	8	M6	1,20	
23835	130 A	8	-	75	34	36	5	11	M8	3,00	
23836	200 A	10	-	81	34	42	5	13	M10	5,00	
23837	230 A	12	18	87	34	48	5	13	M12	7,70	
23838	300 A	14	20	95	38	50	7	17	M14	11,80	
23839	350 A	16	22	103	38	58	7	19	M16	16,60	
23840	400 A	18	25	107	42	58	7	22	M16	19,90	
23841	500 A	20	28	119	42	70	7	24	M18	26,50	
23842	700 A	25	38	145	62	74	9	32	M20	49,60	
23843	900 A	30	42	152	62	81	9	36	M24 x 2	73,00	
23844	1200 A	35	48	162	62	90	10	41	M30 x 2	112,60	
23845	1500 A	40	52	178	62	105	11	46	M36 x 3	162,30	

Plugs without snap-in lock. Suitable to screw into cable lugs, bus-bars, contact-blocks or as plug built into insulated housings for the slide-in rack technology. The amperages were measured at + 20° C ambient temperature and an end temperature of max. + 80° C.

**Sockets 80-300 A**

with snap-in lock and crimp connection

Material: brass, silver plated

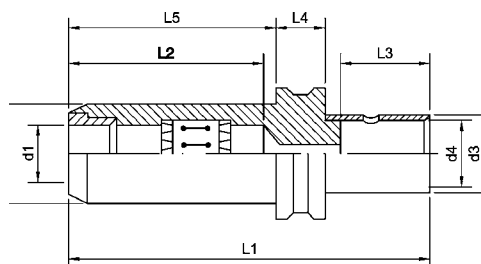

Part-No.	cross-section mm <sup>2</sup>	rated-current	dimensions mm									weight kg/% pcs.
			d <sub>1</sub>	d <sub>2</sub>	d <sub>3</sub>	d <sub>4</sub>	L <sub>1</sub>	L <sub>2</sub>	L <sub>3</sub>	L <sub>4</sub>	L <sub>5</sub>	
23850	10	80 A	6	12	8	5	48,5	23	14	-	28	2,60
23851	16	100 A	6	12	9	6	48,5	23	14	-	28	2,60
23852	25	130 A	6	12	11	8	54,5	23	16	-	28	2,60
23853	25	130 A	10	16	11	8	76	43	15	12	45	8,30
23854	35	150 A	10	16	13	9	81	43	20	12	45	8,40
23855	50	180 A	10	16	14,5	11	88	43	27	12	45	8,90
23856	50	190 A	14	21	14,5	11	93	43	27	17	45	14,50
23857	70	240 A	14	21	17	13	93	43	27	17	45	14,90
23858	95	280 A	14	21	20	15	95	43	29	17	45	16,30
23859	120	300 A	14	21	22	17	96	43	30	17	45	16,80

Sockets with snap-in lock which lock automatically when connected. Plugs are inserted only so far that the ring snap-in. To release the connection, lightly turn and push-in plug, then pull-out. Crimp connection for flexible/highly flexible copper cables. The amperages were measured at + 20° C ambient temperature and an end temperature of max. + 80° C.

**Plugs 80-300 A**

with snap-in lock and crimp connection

Material: brass, silver plated

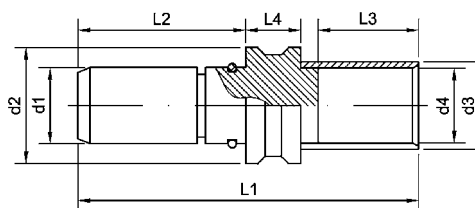

Part-No.	cross-section mm <sup>2</sup>	rated-current	dimensions mm									weight kg/% pcs.
			d <sub>1</sub>	d <sub>2</sub>	d <sub>3</sub>	d <sub>4</sub>	L <sub>1</sub>	L <sub>2</sub>	L <sub>3</sub>	L <sub>4</sub>		
23870	10	80 A	6	9	8	5	45	22	14	7	1,20	
23871	16	100 A	6	9	9	6	45	22	14	7	1,30	
23872	25	130 A	6	9	11	9	51	22	20	7	1,60	
23873	25	130 A	10	20,5	11	8	73,5	42,5	16	12	6,60	
23874	35	150 A	10	20,5	13	9	78,5	42,5	21	12	7,30	
23875	50	180 A	10	20,5	14,5	11	85,5	42,5	28	12	7,40	
23876	50	190 A	14	25	14,5	11	91	43	27	17	13,30	
23877	70	240 A	14	25	17	13	91	43	27	17	13,80	
23878	95	280 A	14	25	20	15	93	43	29	17	15,00	
23879	120	300 A	14	25	22	17	94	43	30	17	15,80	

Plugs are suitable for all sockets with snap-in lock Part-No. 23850-59. Plugs are inserted only so far that the ring snaps-in. To release the connection, lightly turn and push-in plug, then pull out. Crimp connection for flexible/highly flexible copper cables. The amperages were measured at + 20° C ambient temperature and an end temperature of max. + 80° C.

**Flexible connectors with plugs and sockets 80-300 A**

made out of highly flexible silicone insulated cable  
with solderless pressed connectors on one side  
and plug or socket with snap-in lock on the other side

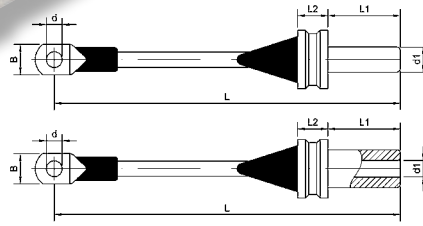
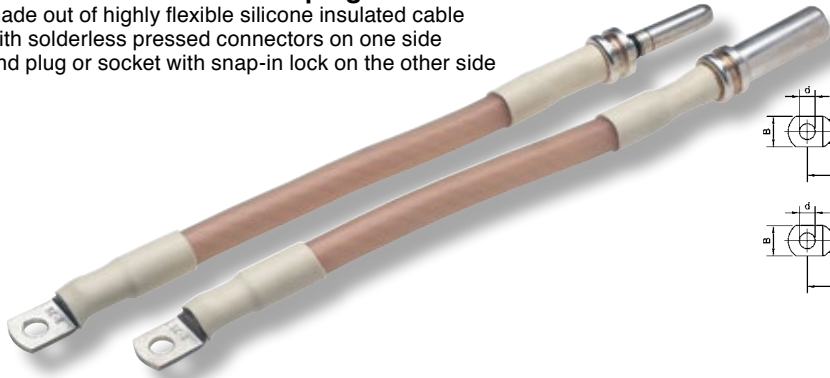

Part-No.		cross-section mm <sup>2</sup>	rated-current	d <sub>1</sub>	d	dimensions mm		L <sub>1</sub>	L <sub>2</sub>
type A	type B					B	L		
16320	16325	10	80 A	6	6,5	11	depending on customers requirements	22	7
16330	16335	16	100 A	6	8,5	15		22	7
16331	16336	25	130 A	6	8,5	16		22	7
16340	16345	25	130 A	10	8,5	16		42,5	12
16350	16355	35	150 A	10	8,5	17		42,5	12
16351	16356	50	180 A	10	10,5	22		42,5	12
16360	16365	50	190 A	14	10,5	22		43	17
16370	16375	70	240 A	14	10,5	25		43	17
16380	16385	95	280 A	14	13	29		43	17
16390	16395	120	300 A	14	13	31		43	17

**Type A:** one side tubular cable lug and plug at the other side

**Type B:** one side tubular cable lug and socket at the other side

**Cable:** free of halogen, flame retardant with stabilized insulation (oper.temp. + 180° C). Technical datas on catalogue page 40.

**Sockets 65-5000 A**

with external thread

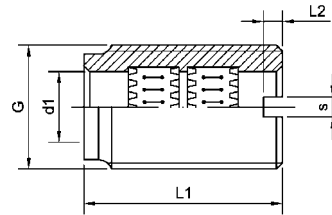

Part-No.	rated-current	d <sub>1</sub>	dimensions mm				starting torque Nm max.	BE-lams pcs.	weight kg/% pcs.
			G	L <sub>1</sub>	L <sub>2</sub>	s			
23890	65 A	4	M 8 x 0,75	19,5	1,5	1,5	2,5	1	0,50
23891	70 A	5	M 10 x 1	19,5	2	1,5	5	1	0,70
23892	100 A	6	M 12 x 1	19,5	2,5	2	10	1	1,10
23893	130 A	8	M 14 x 1	34	2,5	2,5	13	1	2,10
23894	200 A	10	M 18 x 1	34	2,5	3,5	22	1	3,90
23895	230 A	12	M 20 x 1	34	3,5	3,5	30	1	4,30
23896	300 A	14	M 22 x 1	38	4	4	35	1	5,70
23897	350 A	16	M 24 x 1	38	4	4	35	1	6,30
23898	400 A	18	M 28 x 1	42	4	4	55	1	10,50
23899	500 A	20	M 30 x 1	42	5	5	65	1	11,40
23900	700 A	25	M 42 x 1,5	62	5	5	150	2	39,40
23901	900 A	30	M 48 x 1,5	62	5	5	200	2	48,60
23902	1200 A	35	M 50 x 1,5	62	5	5	220	2	42,70
23903	1500 A	40	M 55 x 1,5	62	6	6	275	2	47,20
23904	1800 A	45	M 60 x 2	62	6	6	430	2	50,20
23905	2000 A	50	M 65 x 2	62	8	7	500	2	55,80
23906	3000 A	60	M 80 x 2	86	8	8	750	3	135,70
23907	3700 A	70	M 90 x 2	86	8	8	1000	3	154,60
23908	4200 A	80	M100 x 2	86	8	8	1500	3	170,20
23909	4500 A	90	M110 x 2	86	8	8	2000	3	187,30
23910	5000 A	100	M120 x 2	86	8	8	2500	3	209,40

The sockets are suitable to screw directly into bus-bars, contact blocks, housings etc. They are slotted at one end suitable for the appropriate mounting tool. The sockets must be screwed against a fix stop or screwed into bus-bars with 2 nuts and washers. The amperages were measured at + 20° C ambient temperature and an end temperature of max. + 80° C.

# 1. ELECTRICAL CONNECTION- AND INSTALLATION TECHNIQUE

## 1.13 Battery clips, battery clamps and earthing tapes

druseidt delivers an assortment of different battery clips and clamps acc. to the DIN-regulation as well as in special design. The delivery of components is added by the customized manufacturing of earthing tapes, jump-loads and cable sets. We deliver also braided copper tapes or round stranded copper cables on rolls or on spools directly from our stock in Remscheid.

If you have interest in such material please be so kind and order our special catalogue no. 2, which informs you about our product range flexible connectors, leadings and ready assembled flexible high current components.



Jump-loads deliverable in normal or startsafe design



**Battery clips 40 A**

with insulated handles

Material: steel sheet, nickel coated



Part-No.		current load	cable connection	length mm	weight kg/% pcs.
black	red				
13345	13346	40 A	solder-connection	80	2,5
10345	10346		crimp-connection		
10347	10348		tab-connection		

Part-No. 13345/46 standardized design for solder-connection.

Part-No. 10345/46 design for crimping with tab-connection 6,3 x 0,8 mm.

Cable cross-section max 4 mm<sup>2</sup>.**Fully insulated battery clips 40 A**

Material: steel sheet, yellow zinc coated



Part-No.		current load	cable connection	length mm	weight kg/% pcs.
black	red				
10350	10351	40 A	solder-connection	80	2,5
10352	10353		crimp-connection		
10354	10355		tab-connection		

Part-No. 10350/51 standardized design for solder-connection.

Part-No. 10352/53 design for crimping or with tab-connection 6,3 x 0,8 mm.

Cable cross-section max 4 mm<sup>2</sup>.**Battery clips 80-600 A**

with insulated handles

Material: steel sheet, zinc coated



Part-No.		current load	max. cable cross-section mm <sup>2</sup>	length mm	weight kg/% pcs.
black	red				
13347	13348	80 A	10	125	6,0
03147	03148	100 A	16	160	10,5
13349	13350	200 A	25	160	16,0
13351	13352	600 A	35	160	22,5

Cable connection crimpable or with cable lug M4 (80 A) or M6 (100-600 A).

600 A design design pole with braided copper tape.

**Fully insulated batter 80-600 A**

Material: steel sheet, zinc coated



Part-No.		current load	max. cable cross-section mm <sup>2</sup>	length mm	weight kg/% pcs.
black	red				
10356	10357	80 A	10	125	6,0
13800	13801	100 A	16	160	10,5
13802	13803	200 A	25	160	16,0
13804	13805	600 A	35	160	22,5

Cable connection crimpable or with cable lug M4 (80 A) or M6 (100-600 A).

600 A design design pole with braided copper tape.

**Battery clips 750-1000 A**

with insulated handles

Material: brass casting, zinc coated 800/1000 A, uncoated 750/900 A



Part-No.		current load	max. cable cross-section mm <sup>2</sup>	length mm	weight kg/% pcs.
black	red				
13332	13333	750 A	50	180	36,00
13353	13354	800 A		150	31,00
13336	13337	900 A		165	31,00
13355	13356	1000 A		150	32,00

900/1000 A design pole connection with braided copper tape.

Cable connection with cable lug M6 or without cable lug (750 A design) with contact bolt.

**Fully insulated battery clips 750-1000 A**

Material: brass casting

Surface: uncoated



Part-No.		current load	max. cable cross-section mm <sup>2</sup>	length mm	weight kg/% pcs.
black	red				
13806	13807	750 A	50	180	36,00
13812	13813	800 A		150	31,00
13816	13817	900 A		165	31,00
13808	13809	1000 A		150	32,00

900/1000 A design pole connection with braided copper tape.

Cable connection with cable lug M6 or without cable lug (750 A design) with contact bolt.

**Fully insulated battery clips 1000 A**

with bended tip

Material: brass casting

Surface: uncoated



Part-No.		current load	max. cable cross-section mm <sup>2</sup>	length mm	weight kg/% pcs.
black	red				
13810	13811	1000 A	50	165	35,00

Pole connection with braided copper tape. Cable connection with cable lug M6.

Design with bended tip for working under cramped conditions.

**Jump-Loads 16-50 mm<sup>2</sup>**

Normal- and startsafe design

with fully insulated battery clips



Part-No.	type	cross-section	length	battery clips design
13780	I	16 mm <sup>2</sup>	2 x 3,0 m	100 A / 13800/01
13782		25 mm <sup>2</sup>	2 x 3,5 m	300 A / 13802/03
13784		35 mm <sup>2</sup>	2 x 4,5 m	500 A / 13805/05/S
13786		35 mm <sup>2</sup>	2 x 5,0 m	900 A / 13816/17
13788		50 mm <sup>2</sup>	2 x 5,0 m	900 A / 13816/17
13790	II	16 mm <sup>2</sup>	2 x 3,0 m	100 A / 13800/01
13792		25 mm <sup>2</sup>	2 x 3,5 m	300 A / 13802/03
13794		35 mm <sup>2</sup>	2 x 4,5 m	500 A / 13804/05/S

Jump-loads type I = Standard design.

Jump-loads type II = Startsafe-design equipped with an additionally circuit to protect electronical parts in the car.

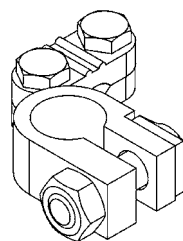
**Battery clamps according to DIN 72331**

Part-No.	DIN-size	cross-section mm <sup>2</sup>	design	material	fixing screw	weight kg/‰ pcs.
03088	A	12 - 70	left +	brass tinned	M8	100,00
03089	B		right -			100,00
03090	C	12 - 70	right +	brass tinned	M8	100,00
03092	D		left -			100,00
03095*	E	50 - 120	links +	brass tinned	M8	150,00
03094	F		right -			150,00
03091*	G	50 - 120	right +	brass tinned	M8	150,00
03093	H		left -			150,00

\*Design with add. lighting cable connection.

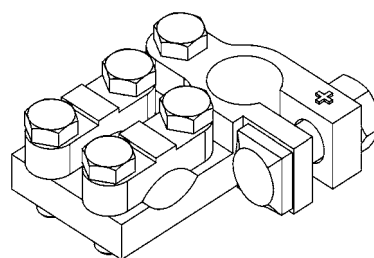
**Battery double clamps**

Part-No.	cross-section mm <sup>2</sup>	design	material	fixing screw	weight kg/‰ Stck
03097	12 - 120	left -	brass tinned	M8	180,00
03100*		right +			180,00

\*Design with add. lighting cable connection.

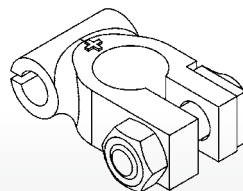
**Battery clamps according to DIN 72332**

Part-No.		cross-section mm <sup>2</sup>	connecting-Ø mm	material	fixing screw	weight kg/‰ pcs.
+ Pole	- Pole					
03108	03116	16	5,6	brass tinned	M8	80,00
03109	03117	25	6,8			80,00
03110	03118	35	8,3			80,00
03111	03119	50	9,7			80,00
03112	03120	70	11,6			80,00
03113	03121	95	13,0			80,00
03114	03122	120	15,0			80,00

## Compression battery clamps

Material: brass, tin plated

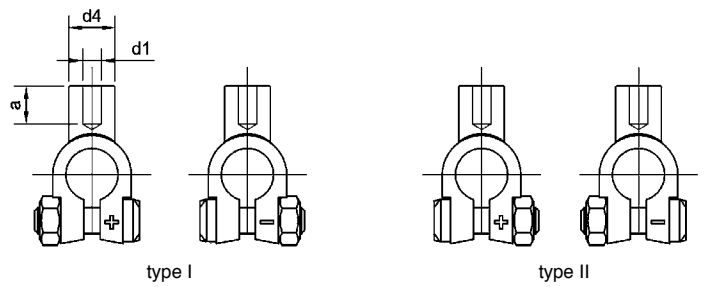

Part-No.		cross-section mm <sup>2</sup>	design	dimensions mm			weight kg/% pcs.	crimping-tools/page no.
type I	type II			d <sub>1</sub>	d <sub>4</sub>	a		
10585/6	10685/6	16	+ Pole	6,0	15	16	80,00	on request
10585/7.3	10685/7.3	25	+ Pole	7,3	15	16	80,00	
10585	10685	35	+ Pole	8,5	15	16	80,00	
10586	10686	50	+ Pole	10,3	15	20	80,00	
10586/13	10686/13	70	+ Pole	13,0	20	20	100,00	
10587/14	10687/14	95	+ Pole	14,0	20	24	110,00	
10587	10687	120	+ Pole	15,0	20	24	110,00	
10595/6	10695/6	16	- Pole	6,0	15	16	80,00	
10595/7.3	10695/7.3	25	- Pole	7,3	15	16	80,00	
10595	10695	35	- Pole	8,5	15	16	80,00	
10596	10696	50	- Pole	10,3	15	20	80,00	
10596/13	10696/13	70	- Pole	13,0	20	20	100,00	
10597/14	10697/14	95	- Pole	14,0	20	24	110,00	
10597	10697	120	- Pole	15,0	20	24	110,00	

All types with fixing screw M8.

## Battery clamps

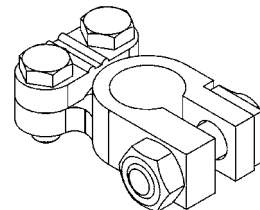
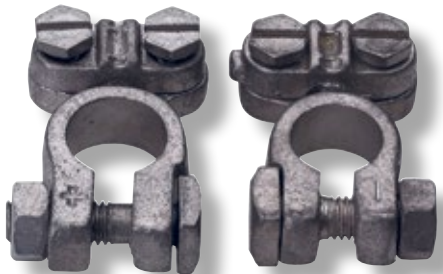

Part-No.	cross-section mm <sup>2</sup>	design	material	fixing screw	weight kg/% pcs.
10600	12 - 70	+ Pole	brass tinned	M8	68,00
10601	12 - 70	- Pole		M8	68,00

## Battery clips 25-50 A

Material: steel sheet, zinc coated



Part-No.		current load	length mm	weight kg/% pcs.
+ Pole	- Pole			
03136 +	03136 -	25 A	75	1,8
03137 +	03137 -	50 A	105	3,8

With screw M4 for cable connection with or without cable lug.



**Earthing tapes**  
similar to DIN 72333 Part 3 design A and B

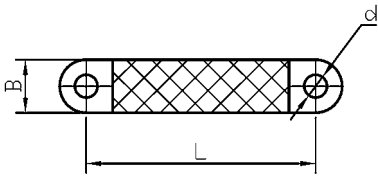

**design A1** contact areas tinned  
**design A2** contact areas with brass-tapes and additionally tinned

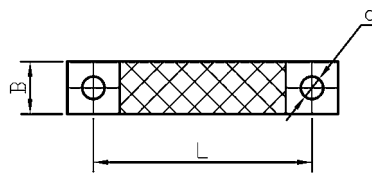

**Form B1** contact areas tinned  
**Form B2** contact areas with brass-tapes and additionally tinned



Part-No.		cross-section mm <sup>2</sup>	dimensions mm		
			B	d	L
15280/A1	15280/A2	4	8	Individually according to customers specification	Individually according to customers specification
15281/A1	15281/A2	6	10		
15282/A1	15282/A2	8	12		
15283/A1	15283/A2	10	14		
15284/A1	15284/A2	14	18		
15285/A1	15285/A2	16	20		
15286/A1	15286/A2	21	22		
15287/A1	15287/A2	25	22		
15288/A1	15288/A2	35	25		
15289/A1	15289/A2	50	33		
15290/A1	15290/A2	70	35		
15280/B1	15280/B2	4	8		
15281/B1	15281/B2	6	10		
15282/B1	15282/B2	8	12		
15283/B1	15283/B2	10	14		
15284/B1	15284/B2	14	18		
15285/B1	15285/B2	16	20		
15286/B1	15286/B2	21	22		
15287/B1	15287/B2	25	22		
15288/B1	15288/B2	35	25		
15289/B1	15289/B2	50	33		
15290/B1	15290/B2	70	35		

**Earthing tapes**  
with solderless crimped battery clamps

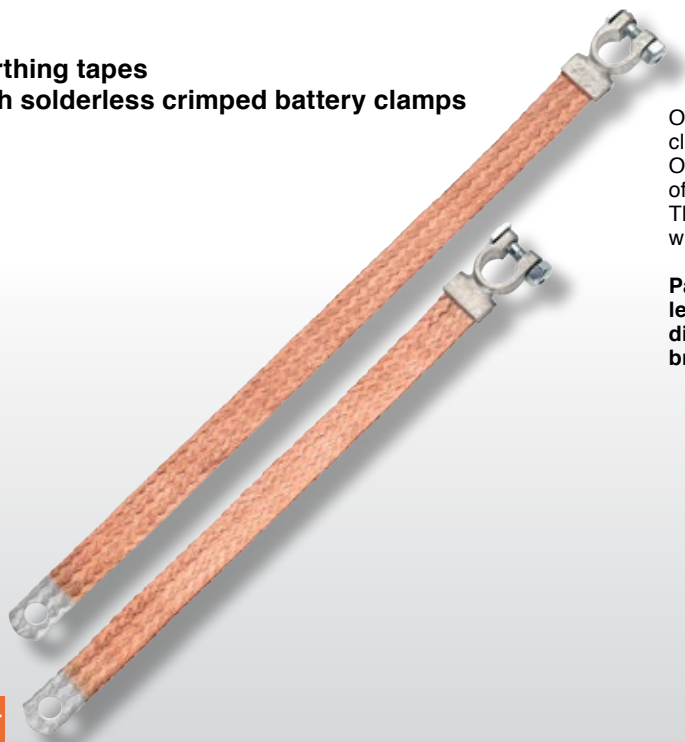

On request we deliver also earthing tapes with solderless crimped battery clamp on one side. The end of the other side can be tinned and punched. One of the standard designs are earthing tapes in a cross section range of 21 mm<sup>2</sup> with a clamp on one side and a hole M10 at the other side. The length can be manufactured according to clients wishes. Therefore when placing an order please specify:

- Part-No.**
- length**
- diameter of the holes**
- braid uncoated or tinned**

# 1. ELECTRICAL CONNECTION- AND INSTALLATION TECHNIQUE

## 1.14 Connectors and accessories for test bay and switch board application as well as cable ties

Additionally to our wide range of products in the field of electrical connection and installation technique, druseidt delivers a selection of accessories for test bay- and switch board application as well as cable ties. The user get so the chance to buy a lot of products by only one supplier.

To facilitate the assignment of test accessories to the appropriate application, standard IEC/EN 61010-031 has established a number of categories which define where they can be used in the power supply network and to lay down appropriate requirements for each category.

In standard EN 61010-031 there are four different test categories, abbreviated "CAT".

As a general rule, the higher the CAT-rating, the higher the safety requirement that applies to the product. One exception is CAT I because this test category includes also measuring objects with higher voltage e. g. battery operated devices inside of cars.



### MEASUREMENT CATEGORIES ACCORDING TO IEC/EN 61010-031

#### CAT I

Applies to test objects that are not connected to the mains. Here we have no complete specific overvoltages, which are not regulated through the rules of insulation coordination. To define requirements for such application it is necessary to know the value of the possible overvoltage. In CAT I you find all test objects that cannot be assigned to CAT II to CAT IV

#### CAT II

Applies to measurements on equipment that is connected to the mains or supplied from the mains without constituting a part of the mains installation (e. g. electrical equipment between consumer load and power outlet inside of electrical devices like household appliance etc.)

#### CAT III

Applies to measurements inside the house or building installation (e. g. fixed installations at houses, contactors, protection equipment, switches, power outlets etc.)

#### CAT IV

Applies to measurements at the supply source of the installation input side. (e. g. secondary side of MV-transformers, electricity meter, connections to overhead lines etc.)

### Highly flexible connecting leads 1 mm<sup>2</sup>

with gold plated brass multilam plugs 4 mm Ø  
 Material of the leading: PVC  
 Operating temperature: -10° C up to + 70° C

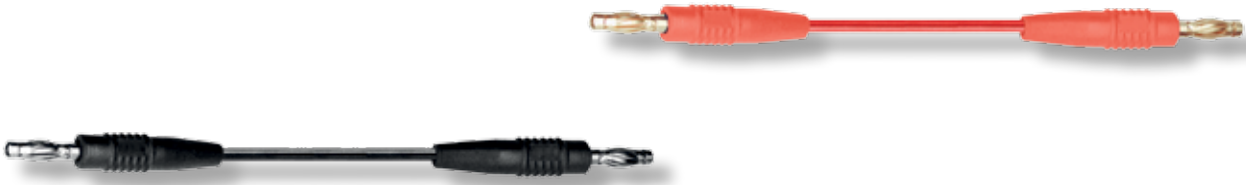

Part-No.				type	flexible length	dimensions plug mm		rated current	rated voltage
black	red	blue	yellow/green			L	Ø sleeve		
24211	24220	24230	24240	LK-410-L	250 mm	55	9	19 A	30 V AC/60 V DC
24212	24221	24231	24241		500 mm				
24213	24222	24232	24242		750 mm				
24214	24223	24233	24243		1000 mm				
24215	24224	24234	24244		1500 mm				
24216	24225	24235	24245		2000 mm				

On request we deliver leadings with different colours or equipped with silicone insulation too.

### Highly flexible connecting leads 2,5 mm<sup>2</sup>

with stackable gold plated brass multilam plugs 4 mm Ø  
 Material of the leading: PVC  
 Operating temperature: -10° C up to + 70° C

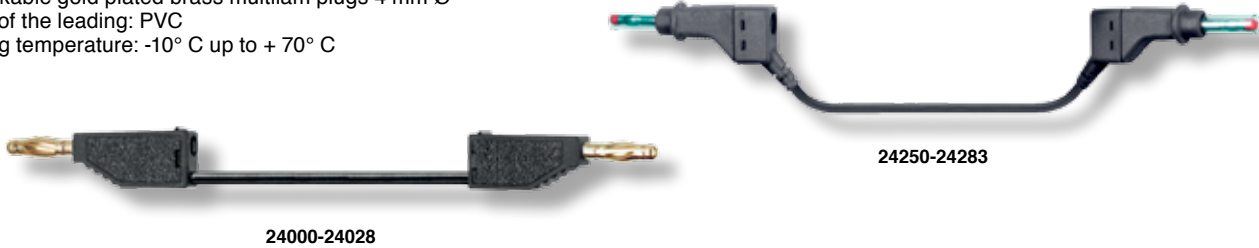

24000-24028

24250-24283

Part-No.				type	flexible length	dimensions plug mm			rated current	rated voltage
black	red	blue	yellow/green			L	B	H		
24000	24008	24016	24024	LK-425-A	250 mm	47	8	15	32 A	30 V AC/60 V DC
24001	24009	24017	24025		500 mm					
24001/1	24009/1	24017/1	24025/1		750 mm					
24002	24010	24018	24026		1000 mm					
24003	24011	24019	24027		1500 mm					
24004	24012	24020	24028		2000 mm					
24250	24260	24270	24280	XZG 425	500 mm	59	14	15	32 A	600 V, CAT II
24251	24261	24271	24281		1000 mm					
24252	24262	24272	24282		1500 mm					
24253	24263	24273	24283		2000 mm					

Type LK 425-A with stackable standard multilam plug 4 mm Ø on both ends

Type XZG 425 with stackable multilam plug on both ends with protective collar and retractable sleeve to prevent accidental touching. Suitable for connecting electrical apparatus not yet equipped with safety sockets. On request we deliver leadings with different colours or equipped with silicone insulation too.

### Highly flexible connecting leads 2,5 mm<sup>2</sup>

with stackable gold plated multilam plugs 4 mm Ø  
 Material on the leading: PVC  
 Operating temperature: - 10° C up to + 70° C



Part-No.				type	flexible length	dimensions plug mm			rated current	rated voltage
black	red	blue	yellow/green			L	B	H		
24070	24078	24086	24094	SLK 425-E	250 mm	56,3	9,5	17,7	32 A	600 V CAT III /
24071	24079	24087	24095		500 mm					1000 V CAT II
24071/1	24079/1	24087/1	24095/1		750 mm					
24072	24080	24088	24096		1000 mm					
24073	24081	24089	24097		1500 mm					
24074	24082	24090	24098		2000 mm					

With stackable 4 mm Ø multilam plugs with rigid insulating sleeve on both ends. On request we deliver leadings with different colours or equipped with silicone insulation too.

### Stackable gold plated plugs 4 mm Ø

with spring-loaded multilam

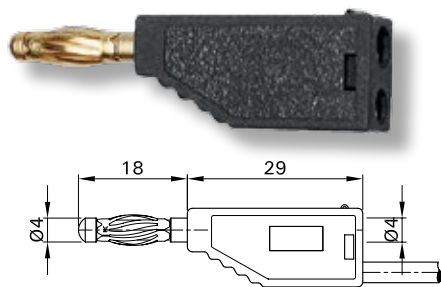

24301-24316

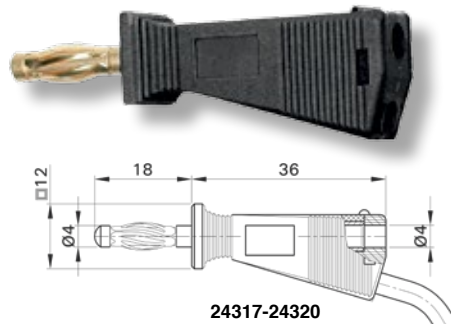

24317-24320

Part-No.				type	connection method	cross-section mm <sup>2</sup>	rated current	rated voltage
black	red	blue	yellow/green					
24301	24302	24303	24304	SLS 410	soldering	1,0	19 A	30 V AC/60 V DC
24305	24306	24307	24308	SLS 415	soldering	1,5	24 A	30 V AC/60 V DC
24309	24310	24311	24312	SLS 425-A	soldering	2,5	32 A	30 V AC/60 V DC
24313	24314	24315	24316	SLS 425-AM	screwing	2,5	32 A	30 V AC/60 V DC
24317	24318	24319	24320	SLS 425	soldering	2,5	32 A	30 V AC/60 V DC

Plugs with other colours as in the table on request.

### Stackable gold plated plugs 4 mm Ø

with spring-loaded multilam and rigid insulating sleeve

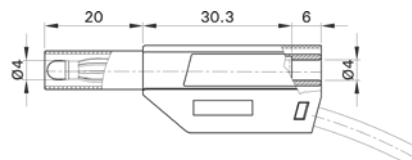

Part-No.				type	connection method	cross-section mm <sup>2</sup>	rated current	rated voltage
black	red	blue	yellow/green					
24321	24322	24323	24324	SLS 425-SE/M	screwing	2,5	32 A	1000 V/CAT II
24325	24326	24327	24328	SLS 425-SE/Q	soldering	2,5	32 A	1000 V/CAT II

### In-line gold plated plugs 4 mm Ø

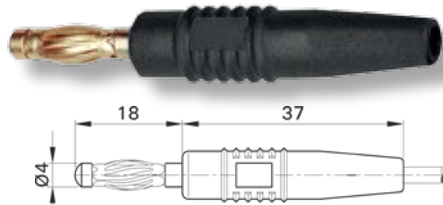

24330-24338

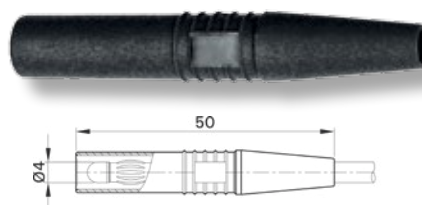

24340-24342

Part-No.			type	connection method	cross-section mm <sup>2</sup>	rated current	rated voltage
black	red	blue					
24330	24331	24332	SLS 410-L	soldering	1,0	19 A	30 V AC/60 V DC
24333	24334	24335	SLS 415-L	soldering	1,5	24 A	30 V AC/60 V DC
24336	24337	24338	SLS 425-L	soldering	2,5	32 A	30 V AC/60 V DC
24340	24341	24342	SLS 425-SL	soldering	2,5	32 A	1000 V/CAT II

Plugs with spring-loaded multilam Part-No. 24340-42 in-line plug with rigid insulating sleeve .

### Clip-on plugs 4 mm Ø

suitable for a clamp connection with stranded wires

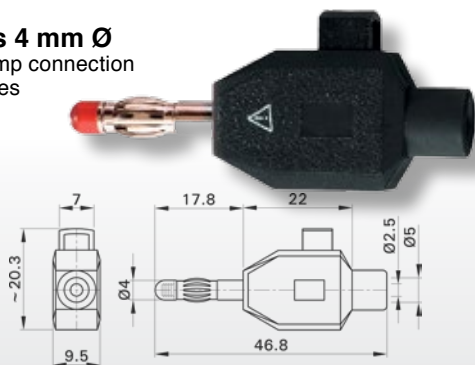

24344-24345

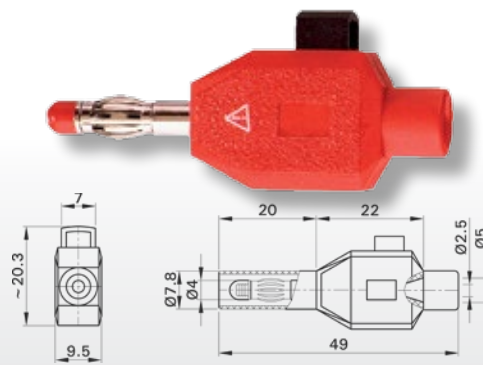

24346-24347

Part-No.		type	connection method	cross-section mm <sup>2</sup>	rated current	rated voltage
black	red					
24344	24345	KL S4	clamping	bis 2,5	10 A	30 V AV/60 V DC
24346	24347	SKL S4	clamping	Bis 2,5	10 A	600 V/CAT II

Please notice that during the installation of the clip-on plugs, the terminal must not be connected to the supply.



### Uninsulated multilam plugs 4 mm Ø

Material: brass

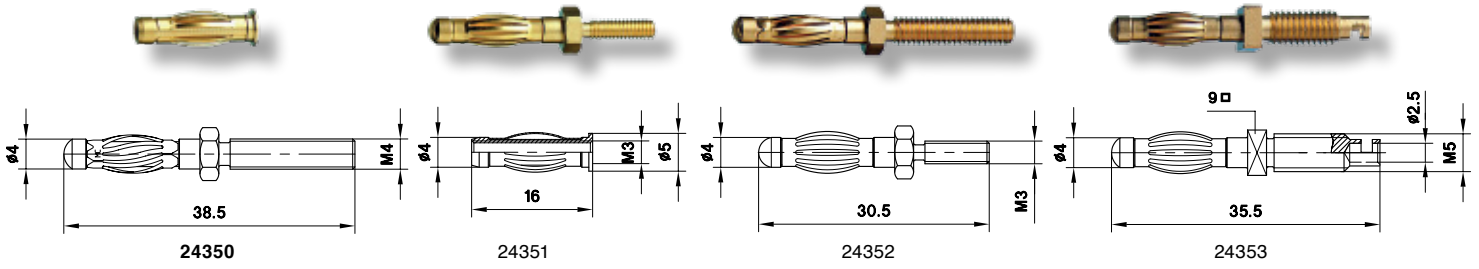

Part-No.	type	surface	connecting	extraction force	highest temperature limit	rated current	resistance mΩ
24350	SA 404	gold plated	M3	ca. 8 N	+ 150° C	50 A	0,3
24351	SA 405	gold plated	M3	ca. 5 N	+ 150° C	50 A	0,3
24352	SA 400	gold plated	M4	ca. 10 N	+ 150° C	50 A	0,2
24353	SA 401	gold plated	M5/solder	ca. 5 N	+ 150° C	50 A	0,3

### Uninsulated multilam plugs 4 mm Ø

Material: brass

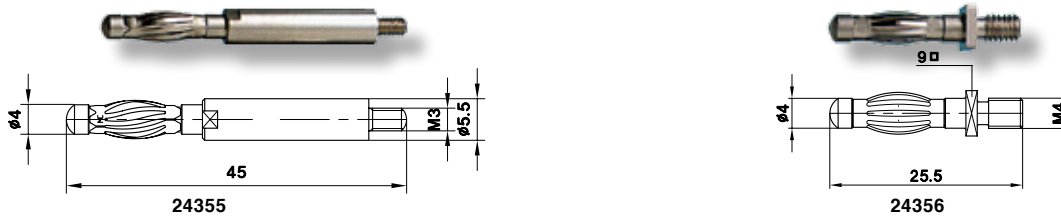

Part-No.	type	surface	connecting	extraction force	highest temperature limit	rated current	resistance mΩ
24355	SA 484	nickel plated	M3	ca. 10 N	+ 150° C	50 A	0,4
24356	SA 486	nickel plated	M4	ca. 5 N	+ 150° C	50 A	0,8

### Connecting plugs 4 mm Ø

with spring-loaded multilam

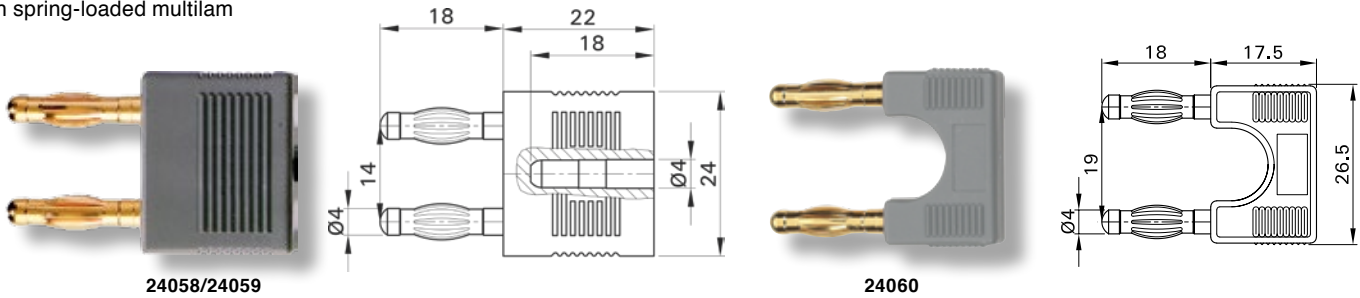

Part-No.	type	colour	surface	inserting distance	rated current	rated voltage
24058	KS4-14 L/N	grey	nickel plated	14 mm	32 A	30 V AC/60 V DC
24059	KS4-14 L/A	grey	gold plated	14 mm	32 A	30 V AC/60 V DC
24060	KS4-19 L	grey	gold plated	19 mm	32 A	30 V AC/60 V DC

Part-No. 24058-59 with rigid socket 4 mm Ø in insulator for tap connection at rear.

Part-No. 24060 made of brass, one piece design.

### Connecting plugs 4 mm Ø

with spring-loaded multilam

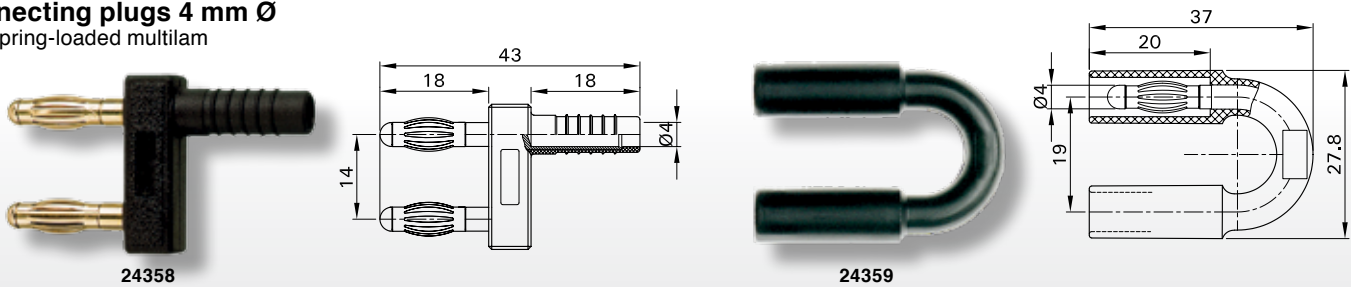

Part-No.	type	colour	surface	inserting distance	rated current	rated voltage
24358	KS4-14 LA/A	black	gold plated	14 mm	32 A	30 V AC/60 V DC
24359	SKS4-19 L	black	gold plated	19 mm	32 A	1000 V/CAT II

Part-No. 24358 designed to ensure vibration-proof-contacts. Ideal for instance in the automotive field for test drives and servicing Rigid socket 4 mm Ø in insulator accepting spring-loaded plugs 4 mm Ø with rigid insulating sleeve

Part-No. 24359 plug with spring-loaded multilam and rigid insulating sleeve

## Uninsulated sockets 4 mm Ø

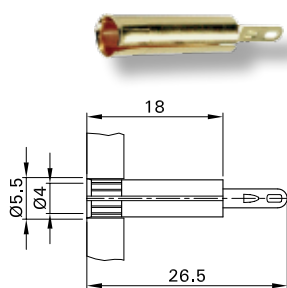

24053

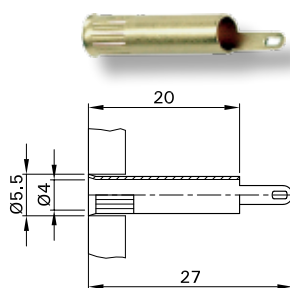

24054

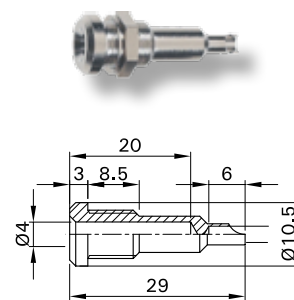

24055/24056

Part-No.	type	surface	connection method	necessary drilling-Ø	rated current	rated voltage
24053	LB 4	gold plated	soldering	4,8 mm	25 A	30 V AC/60 V DC
24054	LB 4 A	gold plated	soldering	4,8 mm	25 A	30 V AC/60 V DC
24055	LB 4 R	nickel plated	soldering	8,3 mm	40 A	30 V AC/60 V DC
24056	LB 4 R/A	gold plated	soldering	8,3 mm	40 A	30 V AC/60 V DC

**Part-No. 24053** made out of rolled brass sheet.

**Part-No. 24054** made out of punched brass tubing.

**Part-No. 24055-56** machined brass. The sockets can be screw-mounted in predrilled panels.

## Insulated press-in sockets 4 mm Ø

with flat connecting tab 4,8 x 0,8 mm

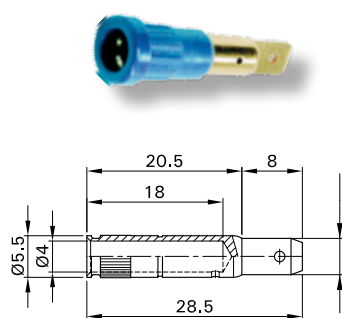

24360-24363

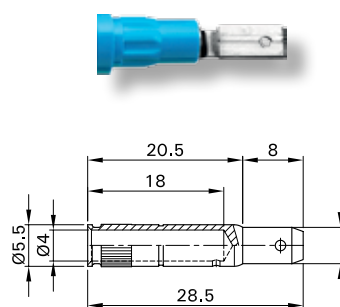
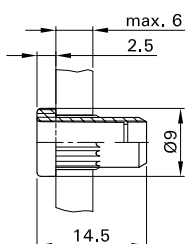

24364-24367

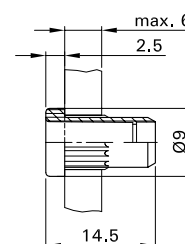

Part-No.				type	surface	necessary drilling-Ø	rated current	rated voltage
black	red	blue	yellow/green					
24360	24361	24362	24363	EB 4	gold plated	6,8 mm	25 A	30 V AC/60 V DC
24364	24365	24366	24367	EB 4-B	nickel plated	6,8 mm	25 A	30 V AC/60 V DC

**Part-No. 24360-63** machined brass.

**Part-No. 24364-67** made out of brass sheet, punched and rolled. The socket is pressed into predrilled panels of plastic, metal etc. Flat connecting tab 4,8 x 0,8 mm can be bent to 90°, once only.

## Insulated press-in sockets 4 mm Ø

with flat connecting tab 4,8 x 0,8 mm

24370-24373

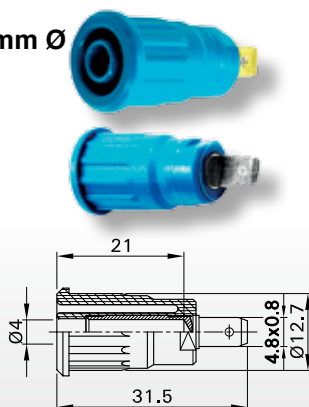

24374-24377

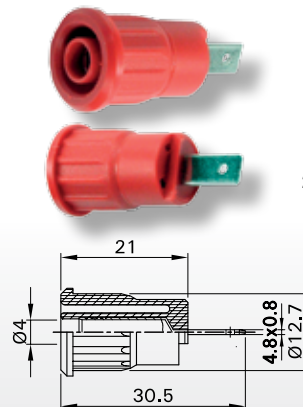

Part-No.				type	surface	necessary drilling-Ø	rated current	rated voltage
black	red	blue	yellow/green					
24370	24371	24372	24373	SEB4-F	gold plated	12,2 mm	24 A	1000 V/CAT III
24374	24375	24376	24377	SEB4-F/A	nickel plated	12,2 mm	24 A	1000 V/CAT III

**Part-No. 24370-73** machined brass.

**Part-No. 24374-77** made out of brass sheet punched. Socket accepting spring-loaded plugs 4 mm Ø with rigid insulating sleeve. The socket is pressed into predrilled panels of metal, plastic etc.

### Panel-mount sockets 4 mm Ø

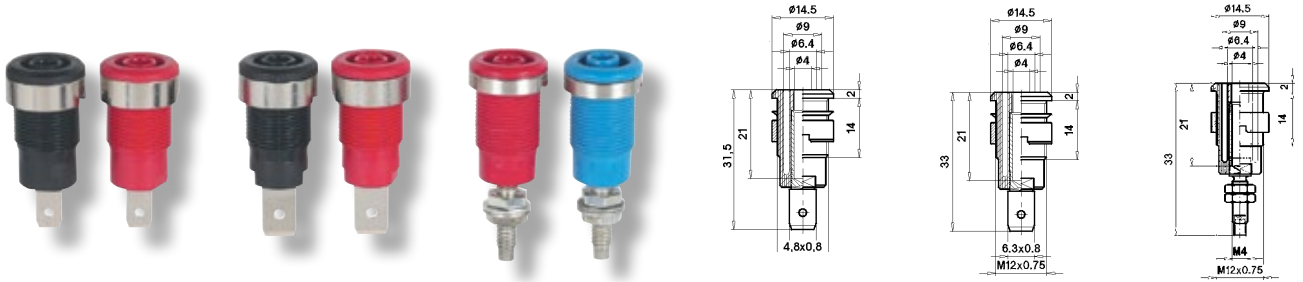

Part-No.				type	surface	necessary drilling-Ø	rated current	rated voltage
black	red	blue	yellow/green					
24400	24401	24402	24403	SLB 4-F	gold plated	12,2 mm	24 A	1000 V/CAT III
12303	12304	12305	12306	SLB4-F/N-X	nickel plated	12,2 mm	24 A	1000 V/CAT III
24404	24405	24406	24407	SLB4 4-F6,3	gold plated	12,2 mm	32 A	1000 V/CAT III
12307	12308	12309	12314	SLB4 4-F6,3/N-X	nickel plated	12,2 mm	32 A	1000 V/CAT III
24408	24409	24410	24411	SLB4-G	gold plated	12,2 mm	32 A	1000 V/CAT III
12315	12316	12317	12322	SBL4-G/N-X	nickel plated	12,2 mm	32 A	1000 V/CAT III

#### Special mounting tools

24110	SS 2	Twist stop spanner
24111	SS 425	Spanner for ring nuts with M12 thread

Delivery with ring nut M12 x 0,75 mm. Part-No. 24400-24411 additionally with washer.

Part-No. 24400-03/12303-06 tab connection 4,8 x 0,8 mm.

Part-No. 24404-07/12307-14 tab connection 6,3 x 0,8 mm.

Part-No. 24408-11/12315-22 connection threaded bolt M4 and soldering hole.

Part-No. 24110-11 devices for easy installation.

Part-No. 24110 is used to counter when tightening the nut with spanner Part-No. 24111.

Sockets with other colours as in the table on request.

### Universal safety sockets 4 mm Ø

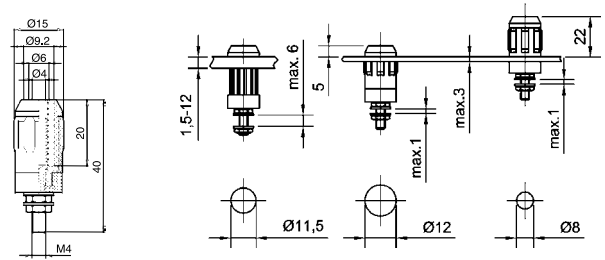

Part-No.				type	surface	necessary drilling-Ø	rated current	rated voltage
black	red	blue	yellow/green					
24105	24106	24107	24108	XUB-G	nickel plated	see drawing	20 A	see text

#### Accessory

24415	24415	Protective cap to cover-up unplugged, unused sockets (Protection degree IP67)
-------	-------	---

Insulated rigid sockets accepting spring-loaded plugs 4 mm Ø with rigid insulation sleeve. The sockets are surface-mounted, assembled flush or pressed into predrilled panels of plastic, metal etc. Rated voltage when surface mounted 600 V, CAT II, when assembled flush or pressed in 1000 V, CAT II. Sockets with other colours as in the table on request.

### Plug- and screw-clamping adapters 4 mm Ø

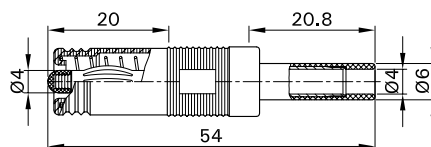

24165

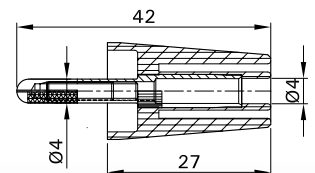

24167-24170

Part-No.				type	surface	rated current	rated voltage
black	red	blue	yellow/green				
<b>Plug-adapter 4 mm Ø</b>							
-	24165	-	-	A4/4-Z	nickel plated	25 A	30 V AC/60 V DC
<b>Screw-clamping adapter 4 mm Ø</b>							
24167	24168	24169	24170	A-SLK-4	gold plated	32 A	1000 V/CAT II

Part-No. 24165 Plug adapter with spring-loaded multilam and retractable sleeve to prevent accidental contact. Rigid socket 4 mm Ø in insulator accepting spring-loaded plugs 4 mm Ø with rigid insulating sleeve.

Part-No. 24167-70 Adapter can be screw-mounted into 4 mm Ø sockets. The expandable 4 mm Ø plug of this adapter can be locked into the socket by tightening the grub screw. Assembled, the adapter offers complete touch-proof protection. Rigid socket Ø 4 mm in insulator accepting spring-loaded plugs 4 mm Ø with rigid insulating sleeves. Please notice that the terminals must not be connected to the supply during installation of the adapters.

## Uninsulated crocodile-clips with socket 4 mm Ø

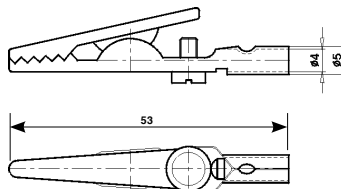

Part-No.	type	material	surface	max. clamping width	rated current	rated voltage
12105	AGK 20	steel	nickel plated	5 mm	10 A	30 V AC/60 V DC

Uninsulated test clip with 4 mm rigid socket. The connection is also possible with screw clamp or soldering.

## Insulated crocodile-clips with socket 4 mm Ø

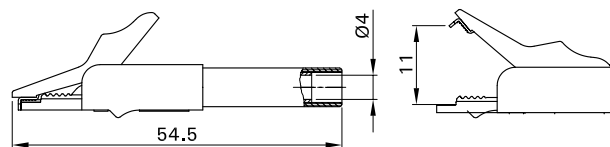
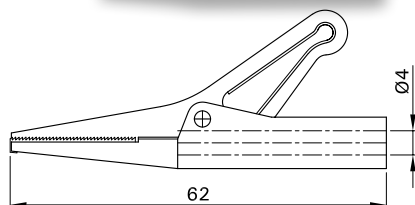

24065-24067

24112-24114

Part-No.			type	surface	max. clamping width	rated current	rated voltage
black	red	blue					
24065	24066	24067	A-PK4	nickel plated	12 mm	10 A	30 V AC/60 V DC
24112	24113	24114	SAGK4-K	Vernickelt	11 mm	15 A	300 V / CAT II

**Part-No. 24065-67** Test clip with Ø 4 mm rigid socket and sharp toothed, pointed jaws. The upper jaw is insulated.

**Part-No. 24112-14** small, slim crocodile clip with all-round-insulation and toothed jaws for wide grip with surface for fine wire. Rigid socket 4 mm Ø in insulator accepting spring-loaded 4 mm Ø plugs with rigid insulation sleeve.

## Insulated crocodile-clips with socket 4 mm Ø

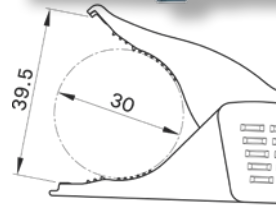
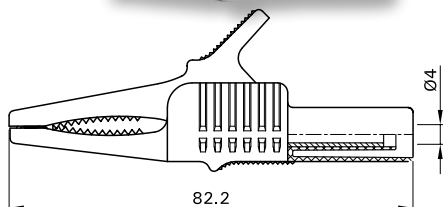

24121-24123

24117-24119

Part-No.				type	surface	max. clamping width	rated current	rated voltage
black	red	blue	yellow/green					
24121	24122	24123	24124	XKK-1001	nickel plated	20 mm	32 A	1000 V/CAT II
24117	24118	24119	24120	XDK-1033	nickel plated	30 mm	32 A	1000 V/CAT III

UL-listed crocodile-clips with all-round-insulation and toothed jaws for wide grip with surface for fine wire. Rigid socket 4 mm Ø in insulator accepting spring-loaded plugs 4 mm Ø with rigid insulation sleeve. Clips with other colours as in the table on request.

## Safety test clips with socket 4 mm Ø



24125-24127

Part-No.			type	total length	max. clamping width	rated current	rated voltage
black	red	blue					
24125	24126	24127	SKPS-4	155 mm	ca. 5 mm	4 A	1000 V/CAT III

**Part-No. 24125-27** with flexible shaft and spring wire grabber made out of stainless steel for a good contact to pins and wires in accessible places. Especially suitable for measuring voltages. The shaft is silicone insulated and guarantees good heat resistance and flexibility even at low temperatures.



## Flat connection clamps with socket 4 mm Ø and adjustable stop

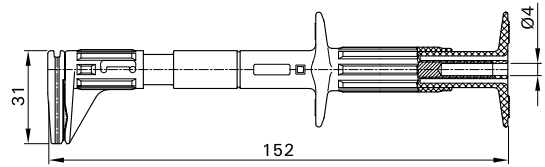

Part-No.			type	surface	total length	max. clamping width	rated current	rated voltage
black	red	blue						
24135	24136	24137	Grip F	nickel plated	152 mm	30 mm	5 A	600 V//CAT III

Flat test clip for making quick, sure contact in voltage measurements. With adjustable stop. Rigid socket 4 mm Ø in handle accepting spring-loaded plugs 4 mm Ø with rigid insulating sleeve.

## Test probes with socket 4 mm Ø



24150/51



24155/56

Part-No.		type	total length	tip length	rated current	rated voltage
black	red					
24150	24151	SPP4-S	122 mm	9 mm	≤1 A	1000 V/CAT II
24155	24156	SPP4-L	140 mm	18 mm	32 A	1000 V/CAT II

**Part-No. 24150/51** with tapered stainless steel rigid needle. Delivery with protection cover.  
**Part-No. 24155/56** Ø 4 mm test probe with spring-loaded multilam. Handle guard chamfered on both sides. Delivery with protection-cover.

## Test plugs and adapters with socket 4 mm Ø

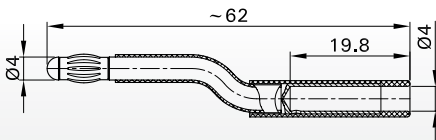

24172

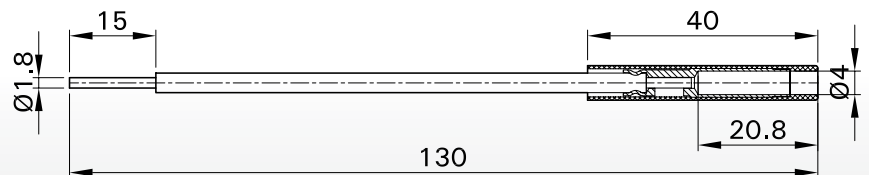

24173

Part-No.	colour	type	material	surface	rated current	rated voltage
24172	black	A-SLK4-RG	Ms	nickel plated	25 A	30 V AC/60 V DC
24173	black	A-SLK4-R	Cu	nickel plated	32 A	1000 V/CAT II

**Part-No. 24172** test plug with spring loaded multilam for connecting into rail mounted terminals with sockets 4 mm Ø. Rigid socket 4 mm Ø in insulator accepting spring-loaded plugs 4 mm Ø with rigid insulation sleeve.

**Part-No. 24173** insulated flexible copper conductor, suitable for many types of screw clamp connections, e.g. rail mounted terminals. Rigid socket 4 mm Ø in insulator accepting spring-loaded plugs 4 mm Ø with rigid insulating sleeves. Please notice that during installation of this adapter the terminal must not be connected to the supply.

**Cable lug adapters**  
with socket 4 mm Ø

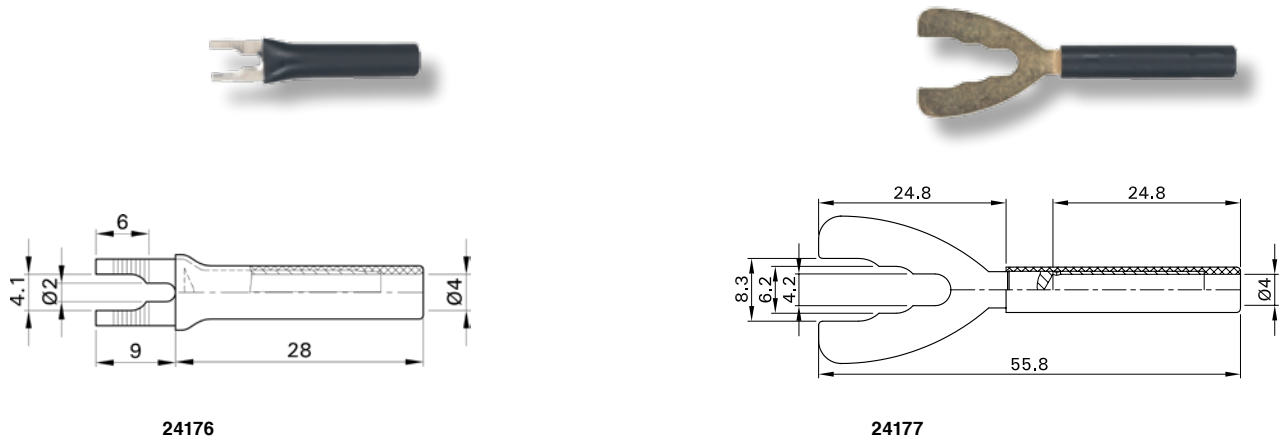

black	Part-No.		type	material	surface	rated current	rated voltage
	red	blue					
24175	24176	24176/1	B4-I/KS	Ms	nickel plated	20 A	1000 V/CAT II
24177	24178	24179	B4-I/K	Ms	gold plated	32 A	1000 V/CAT II

Cable lug adapters for permanent installation e. g. for connecting screw terminals. Rigid socket 4 mm Ø in insulator accepting spring-loaded plugs 4 mm Ø with rigid insulating sleeves. Adapters Part-No. 24175-24176/1 the fork lug can be bent once to 90°. Please notice that during the installation of tis adapters the terminal must not be connected to the supply.

**Insulated lead couplers 4 mm Ø**



black	Part-No.		type	material	surface	rated current	rated voltage
	red	blue					
24420	24421	24422	KK4/4	Ms	gold plated	32 A	1000 V/CAT II

Insulated lead coupler. Both ends suitable for accepting spring-loaded plugs 4 mm Ø with rigid insulating sleeve.

**BNC-adapters resp. BNC adapter leads**

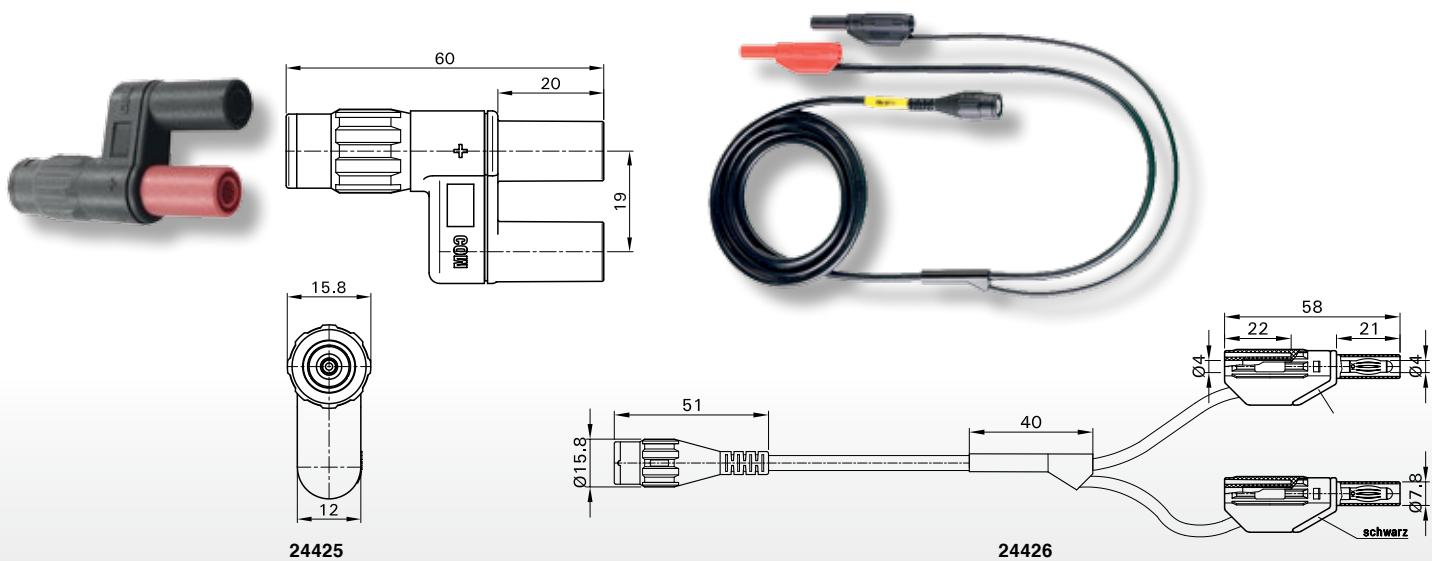

Part-No.	type	length	design	rated voltage
24425	XM-BB/4	60 mm	Adapter with BNC-plug and 2 sockets 4 mm Ø	1000 V/CAT II/600 V/CAT III
24426	XLAM-446/SC	1600 mm	Adapter lead with BNC-plug and 2 plugs 4 mm Ø	600 V/CAT II/300 V/CAT III

**Part-No. 24425** two pole touch-protected adapters with Ø 4 mm connectors linked to the BNC system. With BNC-plug and rigid sockets 4 mm Ø.  
**Part-No. 24426** highly flexible, fully shielded adapter-leads. One end with coaxial cable with touch protected BNC male connector, other end with stackable multilam plugs 4 mm Ø with rigid insulating sleeve, two-pole version.

## Binding-posts 16-400 A

### Technical information

The AC-flowing through binding posts, sockets and feed-throughs, will locally lead to a radial warming up of the sheet steel enclosure caused by eddy-currents. The following graph No. 1 shows the sheet cut-out dependent on the current intensity. It shows the temperature increase around the binding post by use of a sheet steel enclosure.

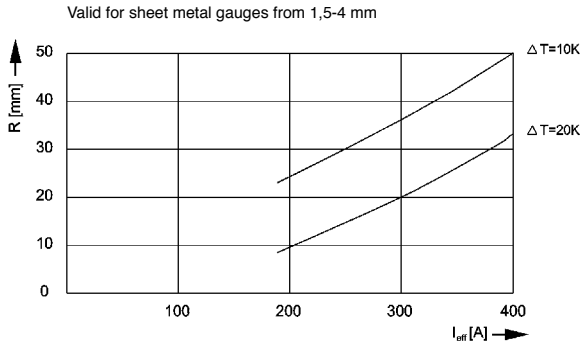
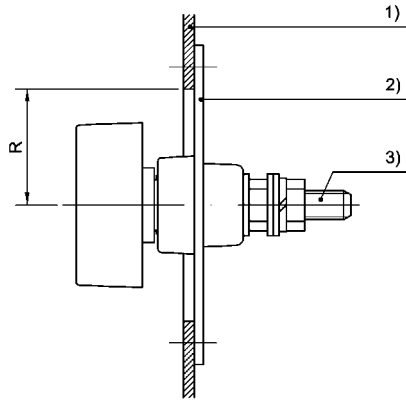

Diagram No. 1

### Example:

Current rating  $I_{eff} = 400$  A

Around the binding posts  $\Delta T = 10$  K are permissible, therefore a radius of 50 mm around the binding posts has to be out of antimagnetic materials. Therefore a mounting has to be done according to the sketch 2. In this figure 1) is the sheet steel enclosure, 2) a antimagnetic material and 3) the binding post.



Sketch 2

### Creepage

The permissible working voltage has to be determined acc. To VDE0110 part 1, IEC 1010 part 1, resp. IEC report 664, taking into consideration the insulating materials and the degree of pollution.

The creepage to be considered is

$$S_K = S_{K_{max}} - S_G$$

$S_K$  = creepage with conducting enclosure  
 $S_{K_{max}}$  = creepage without enclosure  
 $S_G$  = wall thickness of enclosure in mm

### Delivery

All binding posts will be delivered partly assembled with unmounted insulating sockets/rings, nuts, washers and spring washers.

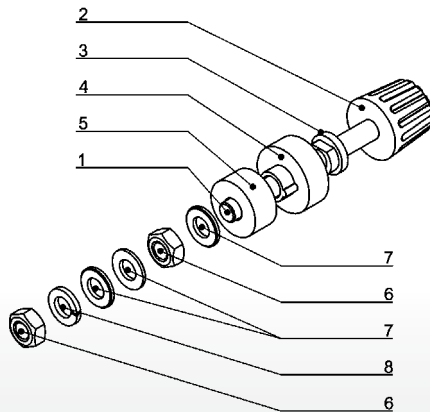

- 1-3 mounted (bolt with insulating- and flange nut)
- 4 Insulating socket with torsion protection
- 5 Insulating ring
- 6 Nuts
- 7 Washers
- 8 Spring washer

### Protected binding posts 16-63 A

Material: brass/polycarbonate  
 Temperature stability: up to + 115° C

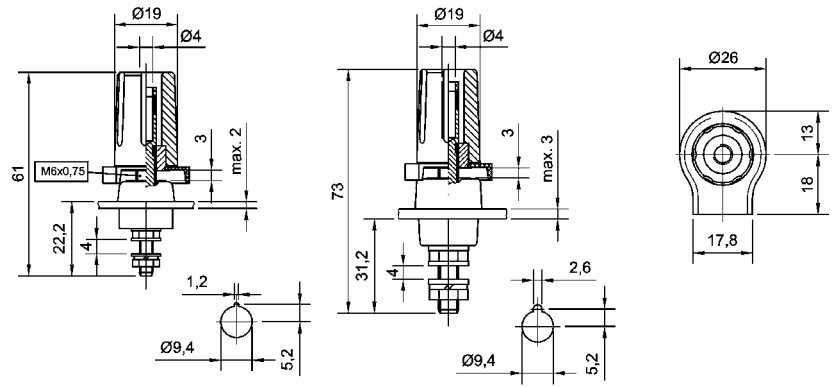

12270-12273

12274-12277

Part-No.	colour	current load	operating voltage	testing voltage	conducting wall thickness (S <sub>e</sub> )	creep-distance S <sub>k</sub>	tightening force
12270	black	16/32 A	1 kV	2,2 kV	2 mm	5,3 mm	1,2 Nm
12271	red						
12272	blue						
12273	yellow-green						
12274	black	32/63 A	1 kV	2,2 kV	3 mm	6,3 mm	3,0 Nm
12275	red						
12276	blue						
12277	yellow-green						

Protection against electric-shock hazards according to VDE 0100 part 410 and 723, VDE 0104, VDE 0110, VDE 0411 and VDE 0470 as well as IEC 664 and IEC 1010 is guaranteed:

- with lug connection after connecting without voltage, if suitable insulation armoured lugs are used
- with connection via 4 mm safety plug with fixed collar

**Technical data:**

Insulation co-ordination: 4 kV/1  
 Design impact potential: 4 kV  
 Insulating material: III a  
 Insulation resistance: > 10<sup>10</sup> Ω  
 Borehole for safety plug: 4 mm Ø

**Rated-current in case of plug connection:**

**Part-No. 12270 up to 12273 16 A**  
**Part-No. 12274 up to 12277 32 A**

### Grounding post 63 A

Material: brass

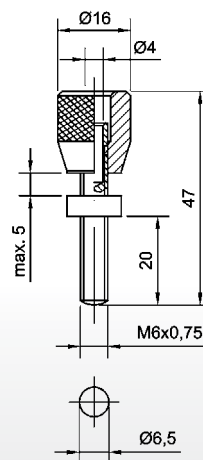

Best-Nr.	current load	plug drilling
05460	16/63 A	4 mm Ø

Rated current by plug connection 16 A



**Binding posts 32-100 A**

Material: brass/polycarbonate

**Technical data**

Working voltage:	1 kV
Insulation co-ordination:	4 kV/1
Design impact potential:	4 kV
Testing voltage:	2,2 kV
Insulating material:	III a
Temperature stability max.:	+ 115° C
Insulation resistance:	> 10 <sup>10</sup> Ω
Borehole for safety plug:	4 mm Ø
Rated current by plug connection max.	16 A

Part-No.	colour	current load	conducting wall thickness (S <sub>o</sub> )	creep-distance S <sub>K max.</sub>	tightening force	dimensions/boreholes mm
12279	black	32 A	2 mm	5,3 mm	1,2 Nm	
12280	red					
12281	blue					
12282	yellow					
12283	green					
12284	violet					
12286	yellow/green					
12287	black	63 A	3 mm	6,3 mm	3 Nm	
12288	red					
12289	blue					
12290	yellow					
12291	green					
12292	violet					
12294	yellow/green					
12295	black	100 A	4 mm	7,5 mm	6 Nm	
12296	red					
12297	blue					
12298	yellow					
12299	green					
12300	violet					
12302	yellow/green					

**Binding posts 63-100 A**

Material: brass/polycarbonate

**Technical data**

Working voltage:	1 kV
Insulation co-ordination:	4 kV/1
Design impact potential:	4 kV
Testing voltage:	2,2 kV
Insulating material:	III a
Temperature stability max.:	+ 115° C
Insulation resistance:	> 10 <sup>10</sup> Ω
Borehole for safety plug:	4 mm Ø
Rated current by plug connection max.	16 A

Part-No.	colour	current load	conducting wall thickness (S <sub>o</sub> )	creep-distance S <sub>K max.</sub>	tightening force	dimensions/boreholes mm
05500	black	63 A	3 mm	6,3 mm	3 Nm	
05501	red					
05502	blue					
05503	yellow					
05504	green					
05505	yellow/green					
05550	black	100 A	4 mm	7,8 mm	6 Nm	
05551	red					
05552	blue					
05553	yellow					
05554	green					
05555	yellow/green					

**Binding posts with flat clamp 63-400 A**

Material: brass or copper/polycarbonate

**Technical data**

Working voltage:	1 kV
Insulation co-ordination:	4 kV/1
Design impact potential:	4 kV
Testing voltage:	2,2 kV
Insulating material:	III a
Temperature stability max.	+ 115° C
Insulation resistance:	> 10 <sup>10</sup> Ω
Borehole for safety plug:	4 mm Ø
Rated current by plug connection max.	16 A

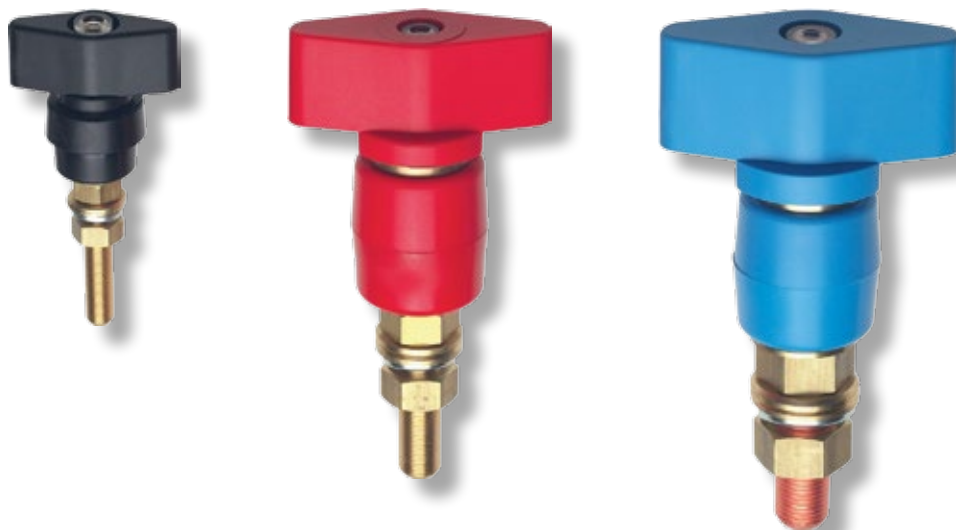

Part-No.	colour	current load	conducting wall thickness (S <sub>e</sub> )	creep-distance S <sub>K max.</sub>	tightening force	dimensions/boreholes mm
05490	black	63 A	3 mm	6,3 mm	3 Nm	
05491	red					
05492	blue					
05493	yellow					
05494	green					
05495	yellow/green					
05530	black	100 A	4 mm	7,8 mm	6 Nm	
05531	red					
05532	blue					
05533	yellow					
05534	green					
05535	yellow/green					
05540	black	100 A	4 mm	7,8 mm	6 Nm	
05541	red					
05542	blue					
05543	yellow					
05544	green					
05545	yellow/green					
05570	black	200 A	9 mm	18 mm	15,5 Nm	
05571	red					
05572	blue					
05573	yellow					
05574	green					
05575	yellow/green					
05580	black	400 A	9 mm	18 mm	30 Nm	
05581	red					
05582	blue					
05583	yellow					
05584	green					
05585	yellow/green					

**Oiltightness lead-through bolts 16-400 A**

Material: brass or copper/molded bakelite



Part-No.	colour	current load	conducting wall thickness (S <sub>e</sub> )	creep-distance S <sub>K max.</sub>	tightening force	dimensions/boreholes mm
05620	black	16 A	10 mm	16,5 mm	1,2 Nm	
05621	black	63 A	10 mm	15,5 mm	3 Nm	
05622	black	100 A	10 mm	17,5 mm	6 Nm	
05623	black	200 A	10 mm	17 mm	10 Nm	
05624	black	400 A	10 mm	18 mm	30 Nm	

Our standard type of gasket rings made out of SIL C 4400 green are free of asbestos and suitable for smooth surfaces. For rough surfaces it is possible to deliver gasket rings made of nitrilbutadiene caoutchouc (Perbunan). For proper installation, the flange washer fixed to the bolt has to be located inside the enclosure. In general, first lock the lead through bolt with the lower nut, leave a space and then make the electrical connection between the two remaining nuts.

**Technical data**

Working voltage:	1 kV
Insulation co-ordination:	5 kV/1
Design impact potential:	5 kV
Testing voltage:	3,2 kV
Insulating material:	II
Temperature stability:	bis + 100° C
Insulation resistance:	> 10 <sup>9</sup> Ω

**Lead-through bolts 63-400 A**

for switch-board application

Material: brass or copper/polycarbonate



Part-No.	colour	current load	conducting wall thickness (S <sub>G</sub> )	creep-distance S <sub>K max.</sub>	tightening force	dimensions/boreholes mm
05626	black	63 A	3 mm	6,3 mm	3 Nm	
05626/1	red					
05626/2	blue					
05627	black	100 A	4 mm	7,8 mm	6 Nm	
05627/1	red					
05627/2	blue					
05628	black	200 A	9 mm	9 mm	15,5 Nm	
05628/1	red					
05628/2	blue					
05629	black	400 A	9 mm	18 mm	30 Nm	
05629/1	red					
05629/2	blue					

For proper installation, the flange washer fixed to the bolt has to be located inside the enclosure. In general, first lock the lead through bolt with the lower nut, leave a space and then make the electrical connection between the two remaining nuts.

**Technical data**

Working voltage:	1 kV
Insulation co-ordination:	4 kV/1
Design impact potential:	4 kV
Testing voltage:	2,2 kV
Insulating material:	III a
Temperature stability:	bis + 115° C
Insulation resistance:	> 10 <sup>9</sup> Ω



### Cable ties

Material: PA 6.6 self extinguishing

Operating temperature: - 40° C up to + 85° C



Part-No.		bundle-Ø max. mm	length mm	width mm	tensile strength min. kg	packing pcs.
natur	black					
30039	30039/s	21	98	2,5	8,2	1000
30042	30042/s	32	135	2,6	8,2	
13230	13230/s	35	140	3,6	13	
30043	30043/s	40	160	2,9	8,2	
30044	30044/s	45	178	4,8	22	
13232	13232/s	50	200	3,6	13	
13231	13231/s	50	200	4,8	22	
30045	30045/s	68	250	4,8	22	100
30049	30049/s	79	290	4,8	22	
30050	30050/s	100	360	4,8	22	
13233	13233/s	100	365	7,8	55	
30051	30051/s	130	450	7,8	55	
30052	30052/s	158	540	7,8	55	
30053	30053/s	200	750	7,8	55	
30054	30054/s	233	780	9,0	77	

black colour = weather-proof design

### Releasable cable ties

Material: PA 6.6 self extinguishing

Operating temperature: - 40° C up to + 85° C

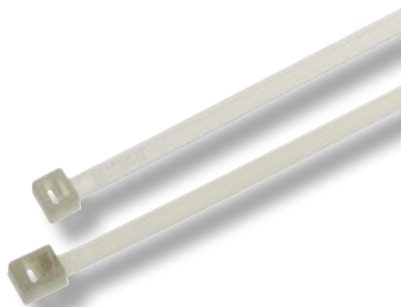

Part-No.	bundle-Ø max. mm	length mm	width mm	tensile strength min. kg	packing pcs.
13228	50	200	4,8	22,2	1000
13229	76	300	4,8	22,2	1000

The same handling as normal cable ties, but easy to release. So a lowering of costs is possible.

### Cable tie mounts

adhesive or screw mounts

Material: PA 6.6, self-extinguishing

Operating temperature: - 40° C up to + 85° C

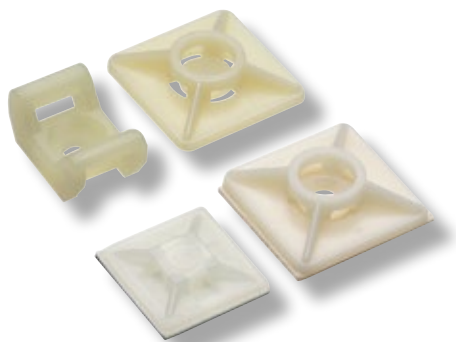

Part-No.	length mm	width mm	height mm	cable tie width max. mm	mounting
13240	19	19	4,3	3,6	adhesive
13241	27	27	4,3	4,8	
13242	22,5	15	11	9	screwable
13243	27	27	8	4,8	

### Adjustable cable tie tool



#### Part-No. 30056

Stabilized adjustable cable tie tool suitable for cable ties up to 4,8 mm width. Easy and safety handling. The tensile strength is adjustable and the value can be inspected through a little window in the tool grip. When cables are bundled at the required strength, the excess tie tail is automatically cropped. So it is possible to prevent injuries caused through a cable tie excess.

# 1. ELECTRICAL CONNECTION- AND INSTALLATION TECHNIQUE

## 1.15 Neoprene sleeves, insulation and shrinking tubes as well as copper paste and cleaning sprays

Often it is necessary to insulate electrical connections during or after the manufacturing process. Therefore druseidt offers additionally to the products of electrical connection technology, insulating material, too. Shrinking-, PVC- as well as silicone tubes delivered in rolls or on spools are standard.

Also neoprene insulation sleeves for an afterwards insulating of cable lugs acc. to catalogue page 122 are interesting products. For cleaning operations as well as optimizing of the current transfer we recommend to use our different sprays or our copper paste.



Mounting of neoprene sleeves by rubber sleeve expanders

### Neoprene sleeves

Temperature stability: -30° C up to + 130° C

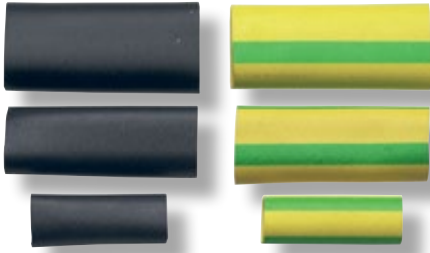

Part-No.		for cable Ø	dimensions mm		
black	yellow-green		cut length	inside-Ø	wall thickness
10025	11025	1,25 - 2	20	1,25	0,5
10026	11026	1,75 - 3,5	20	1,75	0,5
10027	11027	2,4 - 4,5	20	2,4	0,5
10028	11028	3 - 6	25	3	0,6
10029	11029	5 - 9	25	5	0,7
10030	11030	7,5 - 12	30	7,5	0,8
10031	11031	10 - 15	35	10	0,9
10032	11032	12 - 20	50	12	1,2
10033	11033	14 - 23	50	14	1,3
10034	11034	17 - 28	50	17	1,3

Additionally to the standardized colours in white, blue, green, yellow, orange, brown, red, violet, grey or pink colour deliverable.

### Silicone sleeves

Nature colour, free of halogen

Temperature stability: - 80 °C up to + 200 °C,

Reach/RoHS compliant

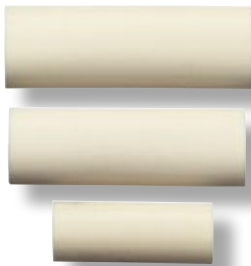

Part-No.	for cable Ø	dimensions mm		
		cut length	inside-Ø	wall thickness
10045	1,25 - 1,8	20	1,25	0,5
10046	1,75 - 2,5	20	1,75	0,5
10047	2,5 - 3	20	2,5	0,6
10048	3 - 4	25	3	0,6
10049	5 - 7	25	5	0,7
10050	7,5 - 9	30	7,5	0,8
10051	10 - 13	35	10	1,0
10052	12 - 16	50	12	1,2
10053	14 - 19	50	14	1,3
10054	17 - 25	50	17	1,3

### Lubricant for neoprene and silicone sleeves



Part-No. 10065 2,5 dl can with brush

For easier application of rubber sleeves. Special product which does not affect caoutchouc or elastomers and is kind to one's skin.

### Rubber sleeve expanders

Ultra light weight in Plio-Carbox design



Part-No.		for max. cable-Ø	dimensions mm			
design A	design B		design A		design B	
			length	width	length	width
10061	10071	4,5	195	115	140	130
10062	10072	9	195	115	140	125
10063	10073	15	195	115	140	125
10064	10074	28	195	115	150	145

**Heat shrinkable tubing**

Material: irradiated cross-linked polyolefin  
Colour: black

**Construction and application**

Extremely flexible thin walled heat shrinkable tubing. Flame retardant and self-extinguishing. Well suited as insulation material for cables, leadings or cable connectors. All tubing are marked with printed UL- and CSA-numbers and therefore well suited for export-orders which require a certificate about the UL/CSA-registration.

Part-No.	Technical data					specification
	before shrinking inside-Ø		after complete shrinking		cut length	
	inch	mm	inside-Ø max. mm	thickness		
30061	3/64	1,2	0,6	0,40	300 m	Shrink-ratio: 2:1
30062	1/16	1,6	0,8	0,43	300 m	Temperature resistance: -55° C up to +125° C
30063	3/32	2,4	1,2	0,51	150 m	Shrink temperature: +90° C
30064	1/8	3,2	1,6	0,51	150 m	Self-extinguishing
30065	3/16	4,8	2,4	0,51	60 m	Dielectric strength: 25 kV/mm
30066	1/4	6,4	3,2	0,64	60 m	Tensile strength: 10,3 MPa
30067	3/8	9,5	4,8	0,64	60 m	Breaking elasticity: 200 %
30068	1/2	12,7	6,4	0,64	60 m	Specification: UL und CSA
30069	3/4	19,1	9,5	0,76	60 m	Standard colour: black, other colours on request
30070	1	25,4	12,7	0,89	60 m	
30072	1 1/2	38,1	19,1	1,02	60 m	
30073	2	50,8	25,4	1,14	60 m	

**Heat shrinkable tubing**

Material: irradiated cross-linked polyolefin  
Colour: transparent

**Construction and application**

Flexible thin walled heat shrinkable tubing with a good mechanical and chemical stability. Don't tear also when shrinking the material about objects with sharp edges. The material offer so multifarious possibilities for application in the industry as well as military field. Suitable for the insulation of busbars, cables, connectors or other power leading parts.

Part-No.	Technical data					specification
	before shrinking inside-Ø		after complete shrinking		cut length	
	inch	mm	inside-Ø max. mm	thickness		
30080	3/64	1,2	0,6	0,40	300 m	Shrink-ratio: 2:1
30081	1/16	1,6	0,8	0,43	300 m	Temperature resistance: -55° C up to +135° C
30082	3/32	2,4	1,2	0,51	150 m	Shrink temperature: +115° C
30083	1/8	3,2	1,6	0,51	150 m	Not self-extinguishing
30084	3/16	4,8	2,4	0,51	60 m	Dielectric strength: 20 kV/mm
30085	1/4	6,4	3,2	0,64	60 m	Tensile strength: 10,3 MPa
30086	3/8	9,5	4,8	0,64	60 m	Breaking elasticity: 200 %
30087	1/2	12,7	6,4	0,64	60 m	Specification: MIL und VG
30088	3/4	19,1	9,5	0,76	60 m	Standard colour: transparent
30089	1	25,4	12,7	0,89	60 m	
30090	1 1/2	38,1	19,1	1,02	60 m	
30091	2	50,8	25,4	1,14	60 m	
30092	3	76,2	38,1	1,27	60 m	
30093	4	101,6	50,8	1,40	30 m	



**Heat shrinkable tubing**

Material: irradiated cross-linked polyolefin  
Colour: black

**Construction and application**

Flexible thin walled heat shrinkable tubing with a good mechanical and chemical stability. Don't tear also when shrinking the material about objects with sharp edges. Easy to mark by printing the outside of the tubing. Therefore multifarious applications are given e.g. insulation of busbars, cables, connectors etc.

Part-No.	Technical data					specification
	before shrinking inside-Ø		after complete shrinking		cut length	
	inch	mm	inside-Ø max. mm	thickness		
30100	3/64	1,2	0,6	0,40	300 m	Shrink-ratio: 2:1
30101	1/16	1,6	0,8	0,43	300 m	Temperature resistance: -55° C bis +135° C
30102	3/32	2,4	1,2	0,51	150 m	Shrink temperature: +90° C
30103	1/8	3,2	1,6	0,51	150 m	Self-extinguishing
30104	3/16	4,8	2,4	0,51	60 m	Dielectric strength: 20 kV/mm
30105	1/4	6,4	3,2	0,64	60 m	Tensile strength: 10,3 MPa
30106	3/8	9,5	4,8	0,64	60 m	Breaking elasticity: 200 %
30107	1/2	12,7	6,4	0,64	60 m	Specification: MIL und UL
30108	3/4	19,1	9,5	0,76	60 m	Standard colour: black, andere colourn auf Anfrage
30109	1	25,4	12,7	0,89	60 m	
30110	1 1/2	38,1	19,1	1,02	60 m	
30111	2	50,8	25,4	1,14	60 m	
30112	3	76,2	38,1	1,27	60 m	
30113	4	101,6	50,8	1,40	30 m	

**Heat shrinkable tubing for earthing applications**

Material: irradiated cross-linked polyolefin  
Colour: yellow/green

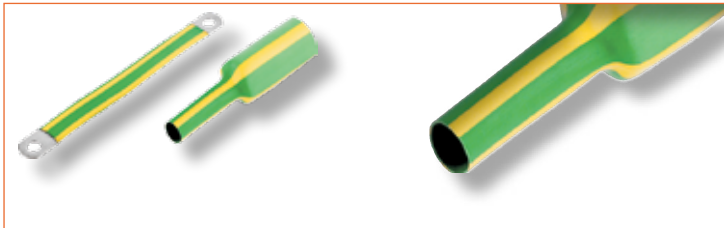
**Construction and application**

Flexible thin walled heat shrinkable tubing, flame retardant and self-extinguishing. Well suited for a marking of earthing connections. Caused by the special production process (dual-colour-extrusion) it is guaranteed that the material either doesn't fade nor it is possible to rub off the colour.

Part-No.	Technical data					specification
	before shrinking inside-Ø		after complete shrinking		cut length	
	inch	mm	inside-Ø max. mm	thickness		
30182	3/64	1,2	0,6	0,41	300 m	Shrink-ratio: 2:1
30183	1/16	1,6	0,8	0,43	300 m	Temperature resistance: -55° C bis +135° C
30184	3/32	2,4	1,2	0,51	150 m	Shrink temperature: +90° C
30185	1/8	3,2	1,6	0,69	150 m	Self-extinguishing
30186	3/16	4,8	2,4	0,84	60 m	Dielectric strength: 20 kV/mm
30187	1/4	6,4	3,2	0,90	60 m	Tensile strength: 10,3 MPa
30188	3/8	9,5	4,8	1,00	60 m	Breaking elasticity: 100 %
30189	1/2	12,7	6,4	1,20	60 m	Specification: MIL und UL
30190	3/4	19,1	9,5	1,40	60 m	Standard colour: yellow/green
30191	1	25,4	12,7	1,80	60 m	
30192	1 1/2	38,1	19,1	2,40	60 m	
30193	2	50,8	25,4	2,40	60 m	

### Heat shrinkable tubing

Material: irradiated cross-linked polyolefin  
colour: black



### Construction and application

Flexible thin walled heat shrinkable tubing with high shrink-ratio (4:1) and less longitudinal change (max. 5 %).  
Well suited for repair works, because only 5 dimensions are needed to cover a wide diameter range.  
Delivery in cut length of 0,9/1,2 m.

Part-No.	Technical data					specification
	before shrinking inside-Ø		after complete shrinking		cut length	
	inch	mm	inside-Ø max. mm	thickness		
13060	1	25,4	6,6	1,52	1,2 m	Shrink-ratio: 4:1
13061	1 1/2	38,1	9,5	1,52	1,2 m	Temperature resistance: -55° C bis +135° C
13062	2	50,8	12,7	1,52	1,2 m	Shrink temperature: +90° C
13063	3	76,2	19,1	1,52	0,9 m	Not self-extinguishing
13064	4	101,6	25,4	1,52	0,9 m	Dielectric strength: 20 kV/mm
						Tensile strength: 10,3 MPa
						Breaking elasticity: 200 %
						Specification: UL und MIL
						Standard colour: black

### Heat shrinkable tubing

Material: irradiated cross-linked polyolefin  
with and without adhesive  
colour: black



### Construction and application

Flexible medium walled heat shrinkable tubing as desired with or without adhesive. Well suited for protecting and insulating of components inside of low voltage or outdoor applications. The adhesive melts when shrinking the tube, so that the components are protected against moisture.  
Delivery in cut length of 1,2 m.

**Type A:** without glue inside, **Type B:** with glue inside

Part-No.		Technical data					specification	
		before shrinking inside-Ø		after complete shrinking		cut length		
		type A	type B	mm	inside-Ø max. mm			thickness
13066	13068			10,2	3,8	1,5	1,2 m	Shrink-ratio: ca. 3:1
30122	15821			19,0	5,6	2,0	1,2 m	Temperature resistance: -55° C bis +125° C
15803	15823			28,0	9,5	2,0	1,2 m	Shrink temperature: +120° C
15804	13069			33,0	10,2	2,0	1,2 m	Not self-extinguishing
30128	15824			38,1	12,7	2,3	1,2 m	Dielectric strength: 20 kV/mm
30129	15825			44,0	14,0	2,3	1,2 m	Tensile strength: 14 MPa
15806	15826			52,1	18,2	2,3	1,2 m	Breaking elasticity: 300 %
15808	15828			70,0	25,5	2,3	1,2 m	Specification: -
15809	15829			90,0	30,0	2,5	1,2 m	Standard colour: black

**Dual wall heat shrinkable tubing with adhesive**

Colour: black

**Construction and application**

Flexible dual wall heat shrinkable tubing. Material of the outer wall polyolefin and polyamide for the inner wall. The adhesive melts when shrinking the tube, so that components are protected against moisture. Delivery in cut length of 1,2 m.

Part-No.	Technical data				specification
	before shrinking	after complete shrinking		cut length	
	inside-Ø mm	inside-Ø max. mm	wall thickness mm		
30195	3	1,0	1,00	1,2 m	Shrink-ratio: 3:1
30196	4,5	1,5	1,00	1,2 m	Temperature resistance: -55° C bis +110° C
30197	6	2,0	1,00	1,2 m	Shrink temperature: +120° C
30198	9	3,0	1,40	1,2 m	Self-extinguishing
30199	12	4,0	1,75	1,2 m	Dielectric strength: 20 kV/mm
30200	19	6,0	2,25	1,2 m	Tensile strength: 16 MPa
30201	24	8,0	2,50	1,2 m	Breaking elasticity: 450 %
					Specification: UL und MIL
					Standard colour: black

**PVC insulating tubing**

Colour: grey

Temperature resistance: -20° C up to +90° C



Part-No.	Technical data		
	inside-Ø	wall thickness ca. mm	quantity per spool
54140	5	0,6	200 m
54142	6	0,6	200 m
54144	7	0,7	200 m
54146	8	0,7	200 m
54148	9	0,7	200 m
54150	10	0,7	100 m
54154	12	0,8	100 m
54158	14	1,0	100 m
54162	16	1,0	100 m
54164	18	1,0	100 m
54166	22	1,2	50 m
54172	24	1,2	50 m
54176	26	1,2	50 m
54178	28	1,2	50 m
54182	30	1,0	25 m
54190	35	1,0	25 m
54192	40	1,0	25 m
54194	45	1,0	25 m
54195	50	1,0	25 m
54196	55	1,0	25 m
54198	60	1,0	25 m
54199	65	1,0	25 m
54200	70	1,0	25 m
54202	75	1,0	25 m
54204	80	1,0	25 m
54206	85	1,0	25 m
54208	90	1,0	25 m
54210	95	1,0	25 m
54211	100	1,0	25 m

**PVC insulating tubing**

Colour: yellow/green

Temperature resistance: -20° C up to -90° C

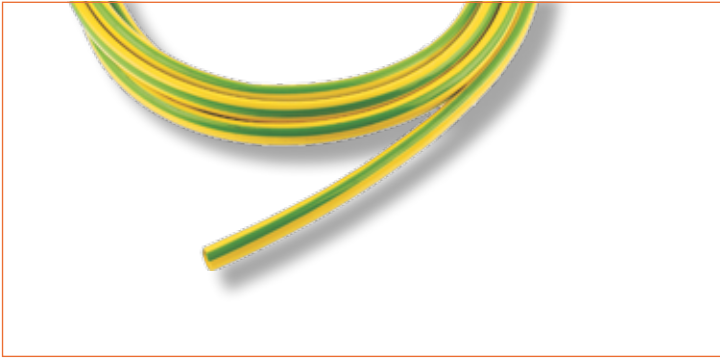

Part-No.	Technical data		
	inside-Ø	wall thickness ca. mm	quantity per spool
13095	2	0,4	50 m
13096	4	0,5	50 m
13097	6	0,6	25 m
13098	8	0,6	25 m
13099	10	0,7	25 m
13100	12	0,8	25 m
13101	14	0,8	25 m
13118	16	0,8	25 m
13119	20	0,8	25 m

**Silicone insulating tubing**

Colour: nature

Temperature resistance: -50° C up to +180° C



Part-No.	Technical data		
	inside-Ø	wall thickness ca. mm	quantity per spool
15890	2	0,4	100 m
15891	3	0,4	100 m
15892	4	0,5	100 m
15893	5	0,6	100 m
15894	6	0,6	100 m
15895	7	0,7	100 m
15896	8	0,7	50 m
15897	10	0,7	50 m
15898	12	0,8	50 m
13102	14	0,8	25 m
13103	18	1,0	25 m
13104	20	1,0	25 m
13105	22	1,0	25 m
13106	24	1,0	25 m
13107	26	1,0	25 m
13108	28	1,0	25 m
13109	30	1,0	25 m
13110	35	1,0	25 m
13111	40	1,0	25 m
13112	45	1,0	25 m
13113	50	1,0	25 m
13114	55	1,0	25 m
13115	60	1,0	25 m
13116	65	1,0	25 m
13117	70	1,0	25 m



## High temperature copper mounting paste as well as protective, maintenance and cleaning sprays



Part-No.	Product name	Content	Description
<b>Cleaners</b>			
02776	Spray Contaclean	200 ml	Eliminates oxide and sulphide build up on metal contact surfaces of all types and builds a long lasting lubrication and corrosion protection.
11260		400 ml	
02778	Spray Wäsche	200 ml	Removes contamination and grease as well as oxide layers produced by Contaclean. Good wash and flow properties allow contamination to be simply rinsed away. A quick and sure way of removing grease and oil, wax and other contamination.
11262		400 ml	
02787	Spray Entfetter	200 ml	Guaranteed water and humidity displacement. Protective and lubricating sprays for ensuring the functionality of cable joins, adapters and is especially suitable for precious metals.
11264		400 ml	
<b>Protectors and Lubricants</b>			
02788	Spray Top-PIN	200 ml	It offers good lubrication and protection against corrosion because of its synthetic properties. The film that spray leaves has very good gliding qualities and withstands heat up to +300° C.
		400 ml	
02779	Spray Silikon	200 ml	High quality, thick insulating oil with a dielectric strength of 12 kV/mm. It will not dry out, is water repellent and is therefore suitable for use as a humidity buffer. It withstands temperatures from 50° C up to +200° C. The material is not poisonous and is a good allround lubricant.
11266		400 ml	
11268	Spray Sprühflon	200 ml	Fat free lubricating and parting compound based PTFE. It offers a low friction coefficient, is anti-adhesive with adhesive materials and can be used on all materials. It is stable when used with chemicals and is electrically insulated. Can be in temperatures from -100° C up to + 260° C.
11261	Spray Antikorr	400 ml	Penetrates dampness, displaces water and protects from corrosion even under the toughest environmental conditions. This material infiltrates the finest pores and cracks. The film left behind is practically invisible and normally must never be removed (painting is the exception).
<b>Coatings</b>			
11265	Spray Plastik	400 ml	High quality acrylic resin transparent lacquer for insulating and sealing. This covers surfaces with a glossy surface which resists acid, lye, alcohol, humidity and environmentally harmful elements. This material bonds to metal, plastic, wood, paper, glass, etc. It can be used under temperatures between -70° C and +120° C.
02774	Spray Isotemp	200 ml	Especially heat-, humidity and weather resistant silicone isolation lacquer. It is functional even in temperatures up to +500° C. This material is hard to burn (UL 94), has good bonding properties and is resilient. It links well at room temperature and is quick functioning.
<b>Copper mounting-paste</b>			
02770	copper paste	1 kg	Smooth, semi-synthetic mounting-paste with fine powder of pure copper. Not dropping, temperature range -30° C up to +1100° C. Suitable for connections and connection bolts which are exposed to and high temperatures and corrosion.

## 2. PRODUCTIVITY BY QUALITY – DRUSEIDT TOOL PRODUCT LINES

We deliver high quality tools  
for a professional working  
with electrical connectors, leadings and cables.



Cutting tools



Stripping tools



Crimping tools



## druseidt – your professional partner for cutting -, stripping- and crimping technology

### Reasons to offer a wide range of tools

In consequence of the various kinds of leadings with different strandings and diameters, combined with the multiplicity types of cable lugs and connectors, also different designs of tools, matched to the individual application, are needed.

To guarantee a professional working according to the regulations it is absolutely necessary that cable lug, leading and the tools are aligned to each other. To have in each case the right professional tool for the multiple working operations it is necessary to offer an extensive tool program. The quality of an electrical crimp-connection is also depending on the quality of the used tools.

### Your advantage – high quality tools

druseidt offers nearly for all usual application a suitable solution. High quality materials combined with an ergonomically design enable an easy handling of the tools. Especially power-assisted tools for cutting cables and leadings as well as crimping cable connectors allows a professional working.

### High class tools and devices for craft, industry and high current application

druseidt offers suitable and professional tools for cutting-, stripping- and crimping operations. All tools are applicable inside of craft, industry or high current application. To take notice of the various kinds of applications and the number of crimping operations we offer simply hand operated tools as well as power-assisted tools and devices up to electrical - or pneumatically driven machines.

### Expert advice, comprehensive testing procedures and total quality management

druseidt offers an expert advice also in the field of high current application. We deliver suitable economically tools or machine technology, matched to our cable lugs and connectors. We support the users by selecting the right components, personal training and creating professional technical instructions. Of course we execute maintenance repairs as well as inspections of all our tools or machines. So it is possible to guarantee a high and constant quality standard for all solderless crimped cable connections.

To check and to document the quality of solderless crimped connectors, we offer as testing procedure the execution of grinding surface pattern.



## 2. CUTTING-, STRIPPING- AND CRIMPING TOOLS

### 2.1 Cutting tools



When working with cables the manufacturing process of making crimping connections starts with the cutting operation. Here you have to pay attention that the different kinds of cables will be cut by a plain and straight cut without appreciable conductor deformation.

For cutting electrical conductors consisting out of copper or aluminium, druseidt offers different designs of cutting tools or devices. So it is possible to select the right cutting tool in dependence of the application, the cross-sections and number of cutting operations. To get an optimized cutting result the design and the material of the blades and cutting knives as well as the stability of the tools are important things. The technical design, lever and force transmission, e. g. by a ratchet etc., determines the necessary cutting force.

Power-assisted cutting tools with ratchet or hydraulic drive enables through their compact structural forms a working also in cramped conditions.



**Cutting tools**

for copper- and aluminium cables



Part-No.	max. cutting-Ø	solid	max. cutting capacity stranded	flexible	length	weight kg/pcs.
12610	20 mm	16 mm <sup>2</sup>	35 mm <sup>2</sup>	70 mm <sup>2</sup>	200 mm	0,35

Not applicable for cutting steel wires, cables with steel insertion and hard drawn solid conductors

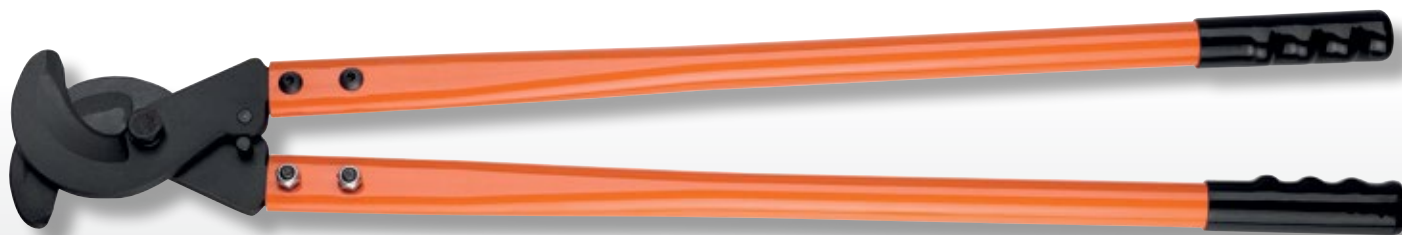
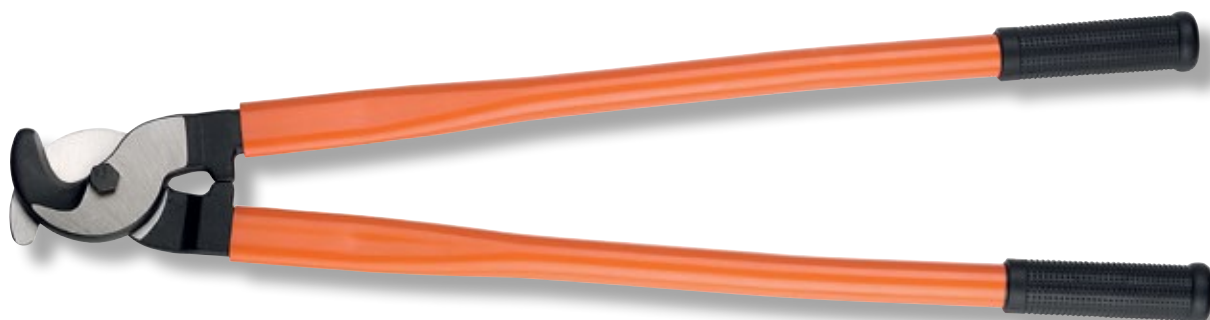

Part-No.	max. cutting-Ø	stranded	max. cutting capacity finestranded	sector shaped conductors	length	weight kg/pcs.
05400	27 mm	120 mm <sup>2</sup>	185 mm <sup>2</sup>	4 x 25 mm <sup>2</sup>	500 mm	1,01
05408	30 mm	120 mm <sup>2</sup>	240 mm <sup>2</sup>	4 x 25 mm <sup>2</sup>	440 mm	1,25
05412	32 mm	150 mm <sup>2</sup>	300 mm <sup>2</sup>	4 x 50 mm <sup>2</sup>	600 mm	1,50
05419	42 mm	300 mm <sup>2</sup>	500 mm <sup>2</sup>	4 x 70 mm <sup>2</sup>	800 mm	3,30

Not applicable for cutting steel wires, cables with steel insertion and hard drawn solid conductors



### Cutting tool for copper- and aluminium cables with jointed arm, ratchet and telescope arms

High quality cutting tools for cutting stranded and flexible copper- and aluminium cables. Not applicable for cutting steel-wires and cables with steel-insertion. Ideal for cramped working spaces. With jointed telescope arms adjust for the ideal grip width. Optimized blade geometry with precision grind and adjustable joint consisting out of hardened special

steel reduce, in combination with the ratchet, the necessary cutting force. Light rigid aluminium handles with 2-component grips and pinch protection. The design and the light weight of only 2 kg offer a comfortable working in cramped conditions.



Optimum force transfer through jointed arm and ratchet

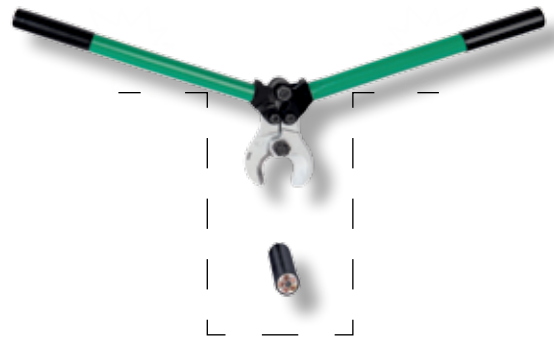

Comfortable working in cramped conditions

Telescope arms adjust to the available working space



- 570 mm
- 620 mm
- 670 mm
- 720 mm
- 770 mm



Part-No.	max. cutting-Ø	stranded	cutting capacities flexible	sector shaped conductors	length	weight kg/pcs.
05402	38 mm	300 mm <sup>2</sup>	300 mm <sup>2</sup>	4 x 70 mm <sup>2</sup>	570 -770 mm	2,00
05403	spare blade for 05402					

Not applicable for cutting steel wires, cables with steel insertion and hard drawn copper conductors

## Cutting tools with ratchet

for copper- and aluminium cables

Mechanical hand operated cable cutters with ratchet and high cutting capacities. The efficient power transmission with the swinging hand lever and the optimal blade geometry offer a cutting of copper- and aluminium cables with low manual forces. The collapsible cutting head, the handy design and the light weight enable a comfortable working

also in cramped conditions. The cable cutter Part-No. 12607 enables a one-hand operation. All cable cutters are not applicable for cutting steel-wires, cables with steel insertion or solid conductors. Only the cable cutter Part-No. 12626 offer additionally a cutting of soft steel thin sheet covered cables.



12607



12603



12626



12609

Part-No.	max. cutting-Ø	max. cutting capacity			length	weight kg/pcs.
		stranded	flexible	sector shaped conductors		
12607	35 mm	240 mm <sup>2</sup>	240 mm <sup>2</sup>	4 x 70 mm <sup>2</sup>	250 mm	0,93
12608	Compensation swinging blade for 12602					
12603	52 mm	400 mm <sup>2</sup>	500 mm <sup>2</sup>	4 x 120 mm <sup>2</sup>	325 mm	1,20
12604	Compensation swinging blade for 12603					
12609	62 mm	750 mm <sup>2</sup>	750 mm <sup>2</sup>	4 x 185 mm <sup>2</sup>	410 mm	2,00
12614	Compensation swinging blade for 12609					
12626	80 mm	1000 mm <sup>2</sup>	1000 mm <sup>2</sup>	4 x 240 mm <sup>2</sup>	610 mm	3,00
12627	Compensation swinging blade for 12626					

## Front cutting tools with ratchet

for copper- and aluminium cables

Mechanical hand operated front cable cutters with ratchet and high cutting capacities. Also suitable for working in cramped conditions such as in tunnels or inside of connecting sleeves. Part-No. 11100 and 11102 with needle bearing. Part-No. 11104 and 11106 with special eccentric drive and optimized cutting knife geometry to enable low force cutting

procedures. The cutting procedure starts when swinging the moveable hand lever. The cable cutter Part-No. 11100 offer a one hand operation. All cable cutters are not applicable for cutting steel-wires, cables with steel insertion or solid conductors.



Part-No.	max. cutting-Ø	stranded	max. cutting capacity flexible	sector shaped conductors	length	weight kg/pcs.
11100	25 mm	120 mm <sup>2</sup>	120 mm <sup>2</sup>	4 x 25 mm <sup>2</sup>	245 mm	0,9
11101	Compensation swinging blade for 11100					
11102	34 mm	185 mm <sup>2</sup>	240 mm <sup>2</sup>	4 x 50 mm <sup>2</sup>	330 mm	1,3
11103	Compensation swinging blade for 11102					
11104	35 mm	240 mm <sup>2</sup>	300 mm <sup>2</sup>	4 x 70 mm <sup>2</sup>	330 mm	1,4
11105	Compensation swinging blade for 11104					
11106	55 mm	500 mm <sup>2</sup>	500 mm <sup>2</sup>	4 x 120 mm <sup>2</sup>	485 mm	3,0
11107	Compensation swinging blade for 11106					

## Tool bags

for cutting tools with ratchet



Part-No.	suitable for cable cutter	design
11110	12607/11100	Made out of woven textile with padding, slip in pocket and zip fastener. Ideally suitable to transport and keep safe our cable cutters with ratchet or similar tools.
11111	12603/11102/11104	
11112	12609/11106	

### Cutting tools with ratchet for copper- and aluminium cables with adjustable telescope arms

Mechanical hand operated cutters with ratchet. Suitable for cutting of stranded and flexible copper- and aluminium as well as soft steel thin sheet covered cables. Not applicable for cutting steel-wires, cables with steel insertion or solid conductors. The telescope arms are adjustable to

a range of length. Combined with the ratchet drive it is possible to realize a cutting procedure with low forces. When activating the emergency release the cutter can be opened in any cutting position. The telescope arms are made out of light rigid aluminium with 2-component grips.



Easy, time-saving use with quick pre-adjustment

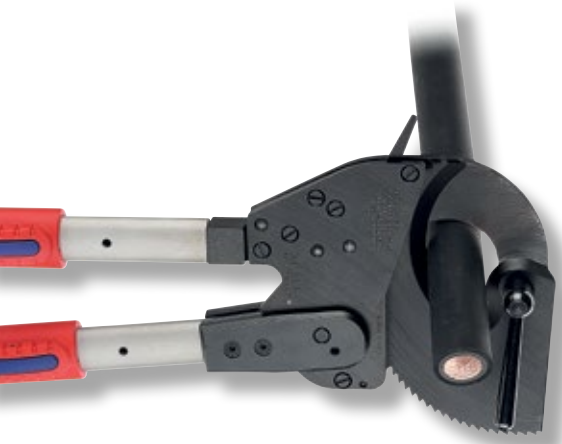

Telescope arms adjust to the available working space



610/660 mm

660/710 mm

710/750 mm

750/810 mm

810/860 mm

Part-No.	max. cutting-Ø	cutting capacities			length mm	weight kg/pcs.
		stranded	flexible	sector shaped conductors		
05404	60 mm	630 mm <sup>2</sup>	800 mm <sup>2</sup>	4 x 185 mm <sup>2</sup>	610-810	3,85
05405	Spare blade for 05404					
05406	100 mm	800 mm <sup>2</sup>	1000 mm <sup>2</sup>	4 x 240 mm <sup>2</sup>	660-860	4,98
05407	Spare blade for 05406					



## Pneumatically actuated cutting device

for flexible copper- and aluminium cables

Universal applicable pneumatically actuated cutting device for cutting of flexible copper- and aluminium cables, hoses or similar products. Simply handling: First insert cable, than push it through the device and activate the cutting procedure by pressing down the foot switch. Finally remove the cutted cable.

All devices are constructed to work with an air-pressure of 6-10 bar. In dependence of the different cutting range the devices are equipped with single-, duplex-, triple- or quadruple cylinder. The cutters are not applicable for cutting steel-wires, cables with steel-inserts or solid conductors. To offer an optimal solution for your cutting application we recommend to send us your cutting materials. With pleasure we'll make cutting tests.



Foot switch

Tabletop unit

Part-No.	max. cutting-Ø	no. of cylinder	cutting capacities		dimensions mm			weight kg/pcs.
			flexible	NYM-leading	L	B	H	
05222	12 mm	1	ca. 10 mm <sup>2</sup>	5 x 1,5 mm <sup>2</sup>	221	80	80	3,00
05224	20 mm	1	ca. 50 mm <sup>2</sup>	4 x 10 mm <sup>2</sup>	255	250	100	5,00
05226	30 mm	2	ca. 120 mm <sup>2</sup>	4 x 25 mm <sup>2</sup>	315	250	100	5,00
05228	45 mm	3	ca. 240 mm <sup>2</sup>	4 x 35 mm <sup>2</sup>	581	350	150	11,00
05229	45 mm	4	ca. 500 mm <sup>2</sup>	4 x 35 mm <sup>2</sup>	688	350	150	12,00

**Remark:** The specified cutting capacities in the table are only circa values. They are in dependence of the hardness and thickness of the insulating material as well as of the cable stranding. All values in the table are identified by an air pressure of 8 bar.

**Battery operated hydraulic cutting tools, druseidt-system with exchangeable tool heads**

for cutting copper-, aluminium- and ACSR cables

druseidt's battery operated cutting tools with electro-hydraulic drive offer an excellent solution for mobile applications as well as working in cramped places. The listed cutting heads are exchangeable and can be also substituted through crimping heads quick and easily. The full system description with all deliverable tool heads and accessories are specified on catalogue pages 174-177.

This new tool generation is characterized by a modern process and control technology combined and equipped with Li-Ion batteries and an USB-interface to connect them with all popular PC-systems. So a maximum of performance, safety and controlling is guaranteed.



Part-No.	scope of supply	technical data	
14240	1 standard set consisting out of: 1 piece battery operated basic unit 60 kN without cutting heads 1 piece Li-Ion battery 1 piece battery charger 1 piece analysis software 1 piece USB connecting lead	Cutting force	60 kN
14243	1 piece cutting head for copper- and aluminium cables up to 55 mm Ø	Operating pressure	700 bar
14244	1 piece cutting head for ACSR-cables up to 45 mm Ø	Cutting head turnable	360°
14245	1 piece steel carrying case	Li-Ion battery	14,4 V/2,6 Ah
12748	1 standard set consisting out of: 1 piece battery operated basic unit 100 kN without cutting heads 1 piece Li-Ion battery 1 piece battery charger 1 piece analysis software 1 piece USB connecting lead	Time of loading	ca. 45 minutes
12751	1 piece cutting head for copper- and aluminium cables up to 54 mm Ø	Battery charger	230 V/50 Hz with 2 m connecting lead
12749	1 piece steel carrying case	Weight in dependence of the used cutting head	5,2-7,5 kg
		Cutting force	100 kN
		Operating pressure	700 bar
		Cutting head turnable	360°
		Li-Ion battery	14,4 V/2,6 Ah
		Time of loading	ca. 45 minutes
		Battery charger	230 V/50 Hz with 2 m connecting lead
		Weight with cutting head	6,1 kg
<b>Accessories</b>			
13553	1 piece spare rechargeable Li-Ion battery		
13554	1 piece additional battery charger		
13555	1 piece 230 V mains adapter		
13538	1 piece harness		

## Battery operated hydraulic cutting tools

for copper- and aluminium cables

Similar to the description on page 138, but with fixed instead of exchangeable cutting heads. Electronic control and inspection of the cutting cycle. Suitable for cutting copper- and aluminium cables up to a

diameter of 50 mm resp. 85 mm. Not applicable for cutting of steel-wires, cables with steel-inserts or solid conductors.



Part-No.	scope of supply	technical data	
13534	1 standard set with cutting-Ø up to 50 mm consisting out of: 1 piece cutting tool 1 piece Li-Ion battery 1 piece battery charger 1 piece analysis software 1 piece USB connecting lead 1 piece steel carrying case	Cutting force	60 kN
		Cutting-Ø	50 mm max.
		Operating pressure	700 bar
		Weight	5,6 kg
		Li-Ion battery	14,4 V/2,6 Ah
		Time of loading	ca. 45 minutes
		Battery charger	230 V/50 Hz with 2 m connecting lead
		With collapsible 360° rotating cutting head	
13535	1 standard set with cutting-Ø up to 85 mm consisting out of: 1 piece cutting tool 1 piece Li-Ion battery 1 piece battery charger 1 piece analysis software 1 piece USB connecting lead 1 piece steel carrying case	Cutting force	70 kN
		Cutting-Ø	85 mm max.
		Operating pressure	700 bar
		Weight	7,6 kg
		Li-Ion battery	14,4 V/2,6 Ah
		Time of loading	ca. 45 minutes
		Battery charger	230 V/50 Hz with 2 m connecting lead
		With collapsible 360° rotating cutting head	
<b>Accessories</b>			
13553	1 piece spare rechargeable Li-Ion battery		
13554	1 piece additional battery charger		
13555	1 piece 230 V mains adapter		
13538	1 piece harness		



**Hydraulic operated cutting heads**

for copper-, aluminium- and ACSR cables

The following described hydraulic operated cutting heads are working with a operating pressure of 700 bar and can be used in combination with our high pressure hydraulic pumps according to the catalogue pages 188-191. Cutting head Part-No. 12832 is applicable for ACSR-cables up to a diameter of 45 mm.

All the other cutting heads are applicable for cutting copper- and aluminium cables in the described diameter range. They are not applicable for cutting steel-wires, cables with steel inserts or solid conductors. They are also not applicable for all kind of live line working.



12832



12833

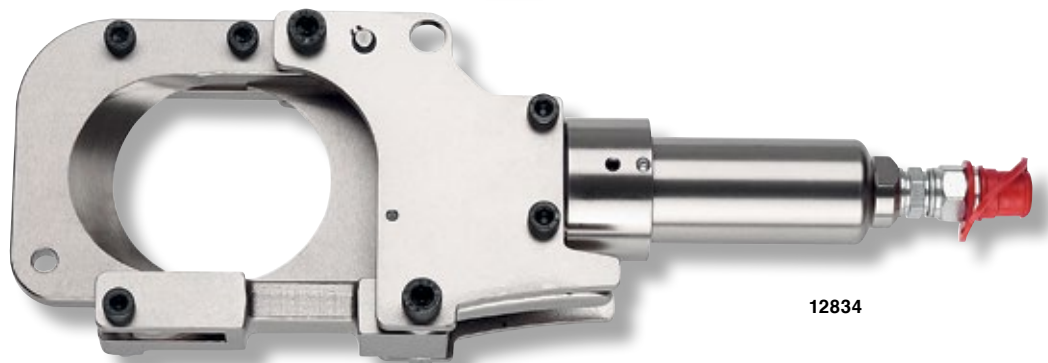

12834



12835

Part-No.	max. cutting-Ø	cutting force	suitable for	length	weight kg/pcs.
12832	45 mm	60 kN	ACSR-Kabel	320 mm	3,5
12833	50 mm	60 kN	Cu-/Al-Kabel	320 mm	2,7
12834	85 mm	70 kN	Cu-/Al-Kabel	420 mm	5,2
12835	95 mm	130 kN	Cu-/Al-Kabel	420 mm	9,8

All cutting heads are equipped with a coupling nipple.



## 2. CUTTING-, STRIPPING AND CRIMPING TOOLS

### 2.2 Stripping tools

After the cables are cut they must be stripped. That means that the conductor insulation must be removed in a defined length, without damaging the wires. To guarantee this, it is necessary to work with a high quality and professional stripping tool, which is aligned to the insulation material and the conductor cross-section. druseidt offers also in the field of stripping procedures high quality tools and devices. In dependence of the material and the number of strippings the user can select the right tools.

Easy hand tools as well as stripping machines are shortly deliverable. Also for problematically insulation materials, like Teflon, Silicone or extra hard materials, solutions are offered too. With pleasure we advise your employees or make stripping tests with your materials.

To realize professional stripping operations it is necessary to avoid mistakes. Some references of mistakes are given in the DIN IEC 60352 part 2 e. g.:

Accurate stripped leading

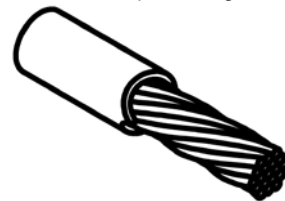

Deposits of the insulation material are on the stripped conductor



Damaged conductor insulation caused by the used stripping tool



Damaged or cutted wires caused by the used stripping tool



To much twisting of the wires



No twisting of the wires

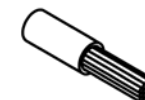

Incorrect insulation cutting



### Stripping tools

for PVC-insolated cables

Self-adjusting stripping tools with and without cable cutter. Suitable for stripping standard cables and leadings with PVC-insulation.

Part-No. 12622 N is a high quality tool with exchangeable stripping blades and excellent stripping capacity.



12642 N



12622 N



12633

Part-No.	stripping capacity		description	length	weight kg/pcs.
	mm <sup>2</sup>	AWG			
12642 N	0,2 - 6	24 - 10	Self-adjusting with cable cutter for flexible cables 2,5 mm <sup>2</sup>	100 mm	0,10
12622 N	0,08 - 6	28 - 10	Self-adjusting with cable cutter for flexible cables 6 mm <sup>2</sup> and solid conductors 4 mm <sup>2</sup>	200 mm	0,15
12623 N	0,08 - 6	28 - 10	Blade set for 12622 N		
12633	6 - 16	10 - 6	Self-adjusting without cable cutter	160 mm	0,13

### Stripping tool with exchangeable blade sets

for different insulating materials

Ergonomic designed, handy and light weight stripping tool. Nearly 90% of wires or leadings can be stripped without adjusting the tool. The exchangeable multiple stripping cassettes enable precision stripping of a wide range of insulations from PVC to PTFE with just one tool. Fine adjustability ensures that fine insulations can be stripped without damage the conductors. Easy exchangeable stripping cassettes for PVC-leadings

up to 16 mm<sup>2</sup> as well as V-shaped stripping blades for problematically insulation materials up to 4 mm<sup>2</sup> offer a wide range of application. Tested to over 150000 cycles. Caused by the high-strength synthetic material (double strength compared with the standard Nylon 6.6. material) a high product reliability and durability is guaranteed.



Easy exchangeable stripping cassettes



V-shaped stripping blades for problematically insulation materials

Part-No.	stripping capacity		description	length	weight kg/pcs.
	mm <sup>2</sup>	AWG			
05190	0,02 - 10	34 - 8	Self-adjusting for PVC-leadings up to 10 mm <sup>2</sup> . With cable cutter for flexible cables 10 mm <sup>2</sup> and solid conductors 1,5 mm <sup>2</sup>	191 mm	0,14
<b>Available stripping cassettes</b>					
05191	4 - 16	12 - 5	Stripping cassette for PVC-leadings		
05192	0,1 - 4	28 - 12	Stripping cassette with V-shaped blade for problematically insulation materials		
05193	0,02 - 10	34 - 8	Replacement stripping cassette for PVC-leadings		

## Stripping tools with exchangeable profile blades

for different insulation materials in a cross-section range up to 16 mm<sup>2</sup>

Extremely stabilized stripping tool with length stop for special application offers a high quality stripping and dismantling of leadings and multi-conductor cables in a cross-section range of 0,03 mm<sup>2</sup> up to 16 mm<sup>2</sup>. Applicable for a great variety of insulations of different hardness. No pinching or deforming of cable ends thanks to a special cutting mode.

For PVC-leadings up to 6 mm<sup>2</sup> and druseidt silicone-leadings 1,8/3 kV up to 16 mm<sup>2</sup> in standard design with mounted stripping blades or alternatively as tool frame without blade sets. A great number of blade sets offer a wide range of stripping application. So it is possible to arrange a stripping set coordinated with the individually requirements.



Stripping tool with mounted profile blade  
05200/05202/05205



Tool frame without profile blade  
05210



Position cable at length stop



Stripping with profile blades



Automatic removal of insulation

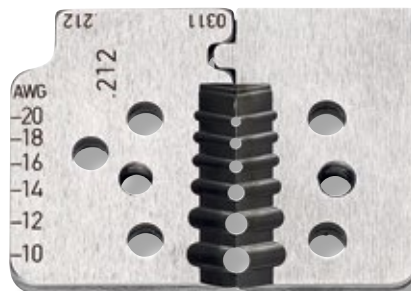
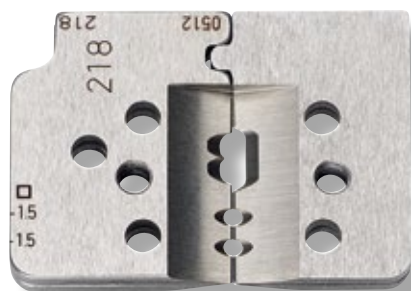

Exchangeable profile blades

Part-No.	stripping capacity		description	length	weight kg/pcs.
	mm <sup>2</sup>	AWG			
<b>Tools with mounted profile blades</b>					
05200	0,14 - 6	26 - 10	for PVC-leadings	200 mm	0,45
05202	4 - 10	11 - 7	for druseidt silicone-leadings 1,8/3 kV and similar	200 mm	0,45
05205	10 - 16	7 - 5	for druseidt silicone-leadings 1,8/3 kV and similar	200 mm	0,45
<b>Tool frame with additional profile blades</b>					
05210	-	-	Tool frame without profile blades	200 mm	0,41
05201	0,14 - 6	26 - 10	Profile blade for PVC-leadings		
05203	6 - 16	10 - 5	Profile blade for PVC-leadings		
05204	4 - 10	11 - 7	Profile blade for druseidt silicone-leadings 1,8/3 kV acc. to catalogue page 40		
05206	10 - 16	7 - 5	Profile blade for druseidt silicone-leadings 1,8/3 kV acc. to catalogue page 40		
05207	2 x 0,35		Profile blade for Profi-Bus-cables with cladding		
05208	0,05 - 0,5	30 - 20	Profile blade for Teflon insulated cables		
05209	0,14 - 1	26 - 16	Profile blade for Teflon insulated cables		
05211	0,03 - 2,08	32 - 14	Profile blade for Teflon insulated cables with cable guiding		
05212	2,5 - 10	13 - 7	Profile blade for Teflon insulated cables		
05213			Profile blade for 1,2 and 4-core POF-cables		
05214	2,5 - 6	13 - 9	Profile blade for solar cable Radox 125		
05215	0,5 - 6	20 - 10	Profile blade for special cables with insulation out of teflon, glass fibre tube and kapton tape		
05216			Profile blade for ASI-Bus cable outer sheath 2 x 1,5 mm <sup>2</sup> /10,2 x 4 mm		
05217	1,5 - 6	15 - 9	Profile blade for solar cables		
05218	4 - 10	11 - 7	Profile blade for solar cables		
05219	3/4 x 0,34 3/5 x 0,5	-	Profile blade for Lumflex-cables		

### Stripping tool

for round shaped cables 4,5 mm up to 40 mm Ø

Professional stripping tool for cables of all insulation types up to a insulation thickness of 4,5 mm. By rotating the body of the tool the blade can be fixed in any one of three positions providing circular cuts around the cable and lengthways or spiral cuts along the cable. Two interchangeable cable retention hooks are standard and offer so an incomparable cable stripping capacity up to 40 mm Ø in one tool. After the stripping operation is finished the blade returns back into the starting position automatically and reduce so the risk of a blade break.

The elevating adjustment can be done very sensitive and no special tools are required to change hooks. One replaces the other by extraction and insertion of the hooks. The well balanced design enables a stripping of ambitious cables also under hard and difficult conditions. Without having sharp edges the tool can be carried in the pocket too. Tested with more than 100000 cycles and made out of high strength synthetic material (double strength compared with the standard Nylon 6.6. material) are additional arguments for the high quality level.



Set with 2 cable retention hooks

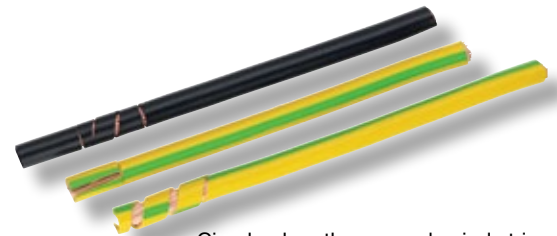

Circular, lengthways and spiral strips



Ergonomic design with feature rests for thumb, first and little fingers to ease raising of the cable retention hook

Part-No.	stripping capacity	insulation thickness max.	description	length	weight kg/pcs.
12843	4,5-40 mm	4,5 mm	Stripping tool with 2 cable retention hooks	150/167 mm	0,12
12844	Replacement blade for 12843				
12845	Little replacement cable retention hook 4,5-25 mm Ø				
12846	Big replacement cable retention hook 20-40 mm Ø				

### Solar cable stripping tool

adjusted for 7 mm and 8,5 mm stripping length

Small, light and easy to handle cable stripping tool, prepare most standard solar cables without adjustment from 2,5-6 mm<sup>2</sup>. Fixed stripping length 7 mm and 8,5 mm that needs no adjustment. Easy handling-clip on cable, rotate, remove tool and insulation slugs. The blades are exchangeable and protected against accidental contact in case of non-working.



Part-No.	stripping capacity	stripping length	description	dimensions mm			weight kg/pcs.
				L	B	H	
05177	2,5-6 mm <sup>2</sup>	7,0/8,5 mm	Stripping tool with stripping cassette	83	22	43	0,02
05179	Replacement blade cassette for 05177						



## Manually operated stripping device

for stripping and dismantling of leadings and cables up to a diameter of 30 mm

Easy to handle, manually operated stripping device for stripping and dismantling of single wires or leadings as well as multicore conductors with different insulation materials. The stripping blades are manufactured in 1 mm steps in dependence of the cable-Ø. Additionally to the standard blades we manufacture various kinds of blades in special design for problematically insulation materials.

All offered standard stripping blades are also applicable for our druseidt silicone insulated leadings 1,8/3 kV according to catalogue page 40.

The stripping blades can be adjusted very easily without any tools to suit your cable-Ø and insulation removal length. Once adjusted a simply pull on the hand lever and the part of the outer insulation is cut and removed. To offer an optimal solution for your stripping application we recommend to send us samples. With pleasure we'll make stripping tests with your material.

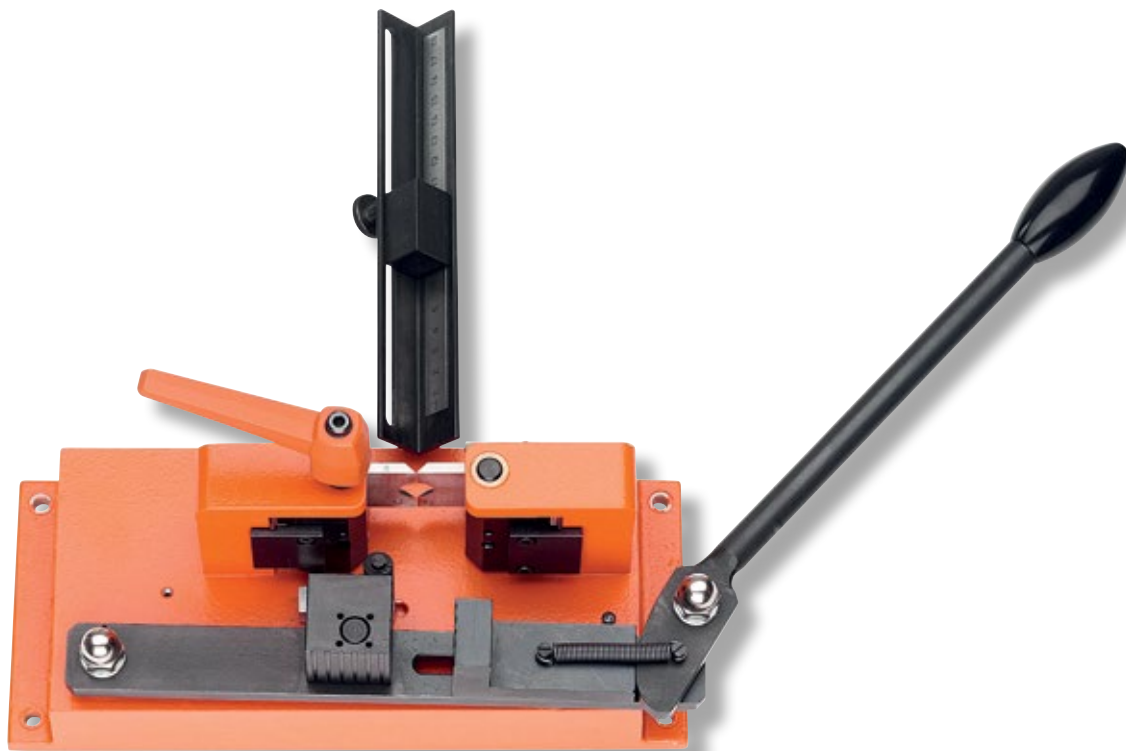

Stripping machine



Pull the clamp lever in order to open the stripping blades

Insert cable and push it at the length stop. Than let the clamp lever loose and pull on the hand lever

Part-No.	stripping capacity	stripping length	description	dimensions mm			weight kg/pcs.
				B	L	H	
05300	up to 30 mm Ø	up to 150 mm	Stripping device without stripping blade	290	125	170	5,00
05301	Standard stripping blade						

## Pneumatically operated stripping machine

for stripping and dismantling of leadings and cables up to a diameter of 25 mm

Universal stripping machine for the economical production of small and medium series. The use of special stripping blades coordinated with the different cables allows an easy handling of nearly all standard cables. When working with extremely soft insulation materials like our silicone insulated leadings 1,8/3 kV according to catalogue page 40 it is necessary to center it by an additional plate (stripping blades Part-No. 05322).

All machine retooling can be done in some seconds without using tools. A delivery with foot-switch is standard. To offer an optimal solution for your stripping application we recommend to send us samples. With pleasure we'll make stripping tests with your material.

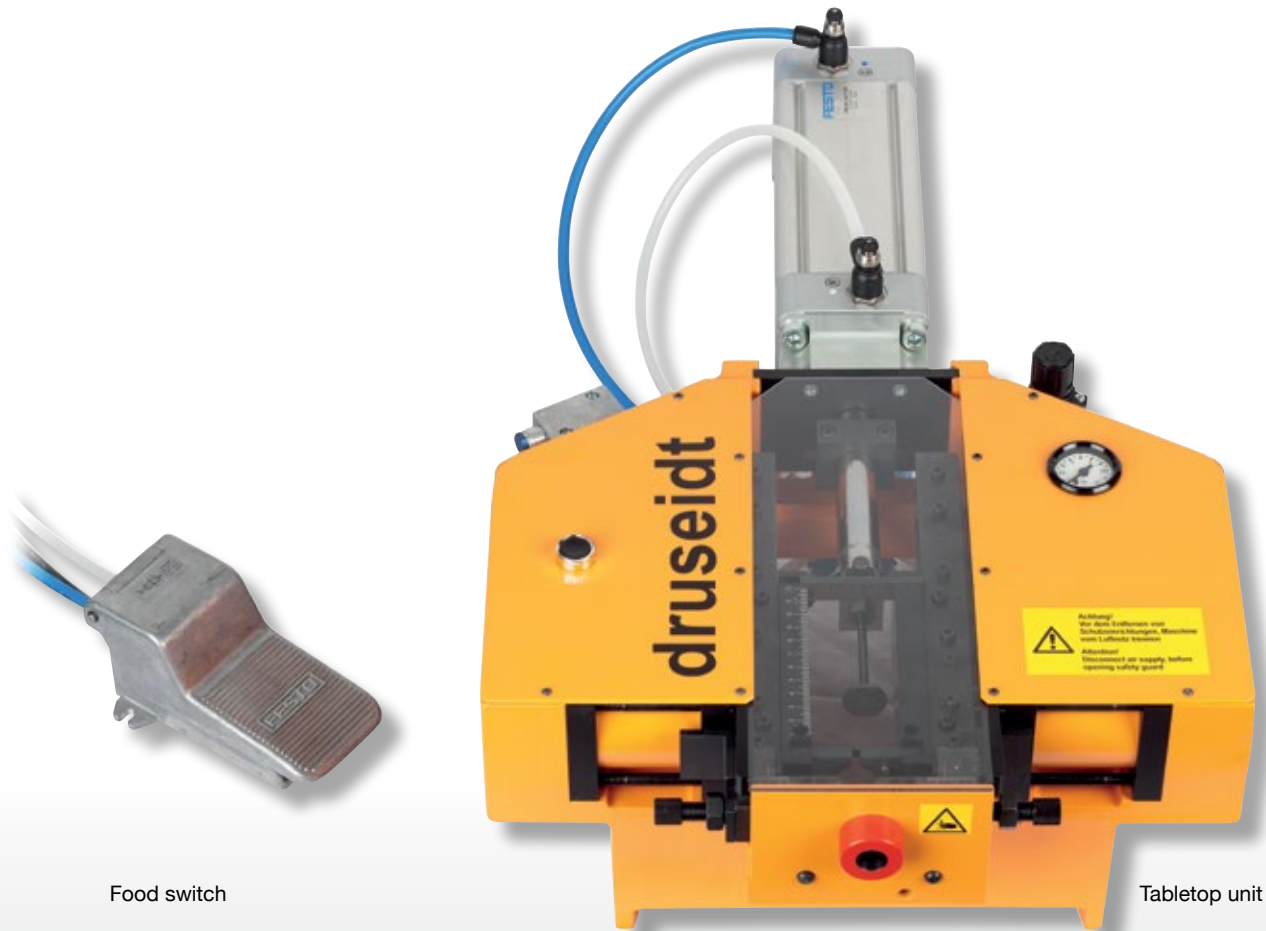
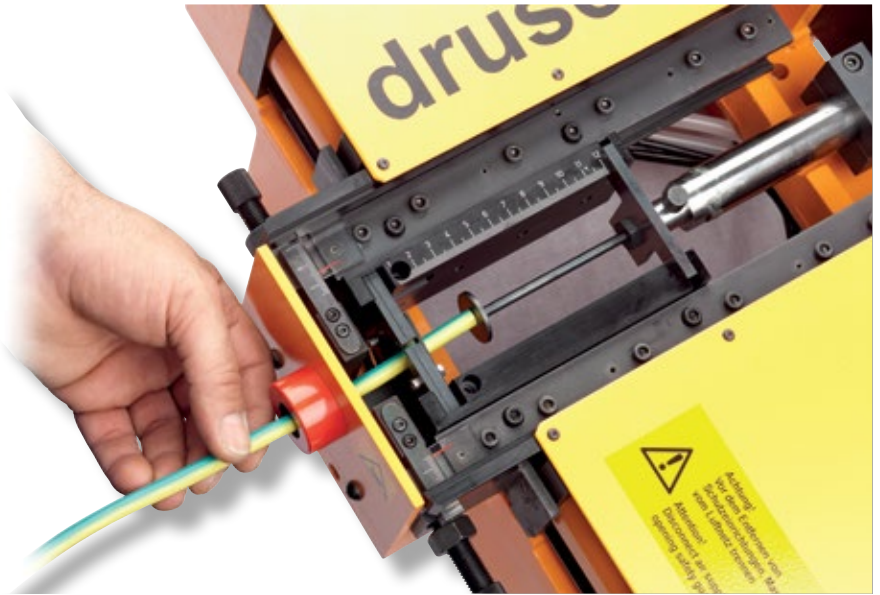

Foot switch

Tablet unit

Part-No.	stripping capacity	max. stripping length by total stripping	description	operating pressure	dimensions mm			weight kg/pcs.
					B	L	H	
05320	1-25 mm Ø	120 mm	Stripping machine without stripping blades	3-6 bar	430	650	245	27,50
05321	Standard stripping blade for 05320							
05322	Stripping blade with additional plate for 05320							

**Stripping machines for bigger cables > 25 mm Ø on request.**

## 2. CUTTING-, STRIPPING AND CRIMPING TOOLS

### 2.3 Crimping tools for cable end sleeves

After the leadings are cutted and stripped the next step is to crimp cable connectors to the conductor ends. This will be normally done by a solderless crimping operation. To prevent a fan out of the conductor ends of stranded or fine stranded copper leadings and to relieve the inserting into clamps, cable end sleeves acc. to DIN 46228 part 1 + 4 in uninsulated as well as insulated design are used. Because the crimping designs are not regulated, different crimping designs acc. to the adjoining table has been established on the market.

To offer to the users their individual preferred or for the application best suited crimping design, druseidt offers various kinds of tools with different forms of die-sets. So tools with self-regulating die-sets with front- or sidewise insertion as well as with separated crimping profiles or as multi functionally tools (cutting-, stripping-, twisting- and crimping inside of one tool) are offered. The tightening forces for the crimped leadings are regulated inside of the EN 60947-1, VDE 0660/part 100 as well as EN 60999 part 1 + 2. Further information are described in the technical appendix on page 205. To realize the described values it is necessary that the outer- $\varnothing$  of the stripped leading and the inside- $\varnothing$  of the cable end sleeve have nearly the same value. The sleeve must be filled on completely and the conductor should be overlap a little bit (in dependence of the cross-section ca. 0,5 mm).

#### Crimping designs for cable end sleeves:

Trapezoid crimping

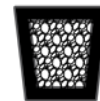

Square crimping

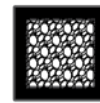

Double-W-crimping

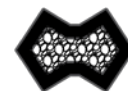

It is necessary to control the crimped cable end sleeve acc. to crimping mistakes e. g.:

- Crack formation or bursting of the sleeve
- Compliance with the crimp geometry (unsymmetrical crimp designs can be identified by a burr formation on the sleeve)
- Squeezing of conductor wires



### Crimping tools for cable end sleeves

acc. to DIN 46228 part 1 and 4



**12637**  
Trapezoid crimping



**05122**



**05125**  
Trapezoid crimping

Part-No.	cross-section range	description	length	weight kg/pcs.
12637	0,25 - 2,5 mm <sup>2</sup>	Simply tool. Trapezoid crimping with cable cutter and spring	140 mm	0,32
05122	0,75 - 16 mm <sup>2</sup>	Universal crimping tool with cable cutter	220 mm	0,31
05125	0,50 - 16 mm <sup>2</sup>	Crimping tool with ratchet and trapezoid crimping. Ferrule insertion from the side. Seven crimping profiles for the rated conductor cross-sections.	230 mm	0,55

**Remark: Part-No. 12637/05122:** Simply, low cost tools. Only applicable for occasional repairing works.

**Part-No. 05125:** Universal tool with ratchet in a good ration in price and performance.



**05124**  
Sqare crimping



**05130**  
Hexagonal crimping



**05131**  
Sqare crimping

Part-No.	cross-section range	description	length	weight kg/pcs.
05124	Single 0,50 - 6 mm <sup>2</sup> Twin 0,50 - 4 mm <sup>2</sup>	Crimping tool with ratchet and sqare crimping Only one die for the whole cross-section range with front insertion	200 mm	0,43
05130	Single 0,08 - 10 mm <sup>2</sup> Twin 0,50 - 6 mm <sup>2</sup>	Crimping tool with ratchet and hexagonal crimping Only one die for the whole cross-section range with ferrule insertion from the side	175 mm	0,41
05131	Single 0,08 - 16 mm <sup>2</sup> Twin 0,50 - 10 mm <sup>2</sup>	Crimping tool with ratchet and sqare crimping. Only one die for the whole cross-section range with ferrule insertion from the side	175 mm	0,41

**Remark: Part-No. 05124:** Handy tools with a good ratio in price and performance. With ratchet which guarantee a constant contact pressure. For cable end sleeves up to a length of 14 mm.

**Part-No. 05130/05131:** High quality crimping tools with only one die for cable end sleeves up to a length of 13 mm. Extremely handy design with ferrule insertion from the side and two component handles.



## Crimping tools for cable end sleeves

acc. to DIN 46228 page 1 and 4



**12640/12641**  
Square crimping



**12646/12647**  
Trapezoid crimping

Part-No.	cross-section range		description	length	weight kg/pcs.
<b>12640</b>	Single	0,08 - 10 mm <sup>2</sup>	Crimping tool with ratchet and square crimping. Only one die for the whole cross-section range with ferrule insertion from the side.	200 mm	0,33
	Twin	0,5 - 4 mm <sup>2</sup>			
<b>12641</b>	Single	2,5 - 16 mm <sup>2</sup>		200 mm	0,33
	Twin	6 - 10 mm <sup>2</sup>			
<b>12646</b>	Single	0,14 - 6 mm <sup>2</sup>	Crimping tool with ratchet and trapezoid crimping. Only one die for the whole cross-section range with front insertion.	230 mm	0,50
	Twin	0,5 - 4 mm <sup>2</sup>			
<b>12647</b>	Single	10 - 16 mm <sup>2</sup>		230 mm	0,55
	Twin	6 - 10 mm <sup>2</sup>			

**Remark:** Tools with high precession crimping and an excellent power gear ration.



**05140**  
Square crimping

**05141**  
Tool with case

**05144**  
Square crimping

Part-No.	cross-section range		description	length	weight kg/pcs.
<b>05140</b>	Single	0,25 - 6 mm <sup>2</sup>	Crimping tool without tool case	130 mm	0,42
	Twin	0,5 - 4 mm <sup>2</sup>			
<b>05141</b>	Single	0,25 - 6 mm <sup>2</sup>	Part-No. 05144 , but with tool case	130 mm	0,42
	Twin	0,5 - 4 mm <sup>2</sup>			
<b>05144</b>	Single	0,08 - 16 mm <sup>2</sup>	Crimping tool with ratchet and square crimping. One switchable die with front insertion.	190 mm	0,48
	Twin	0,5 - 10 mm <sup>2</sup>			

**Remark: Part-No. 05140/41:** Perfect in ergonomics and design. The design with the optimized power gear ratio realize a fatigue-proof work. Max. ferrule length in one crimping operation 12 mm and 18 mm in two crimping operations.

**Part-No. 05144** High quality crimping tool. Only with one crimping die for cable end sleeves in a cross-section range of 0,08-16 mm<sup>2</sup> and a length up to 15 mm. With switchable crimping range (working range 1 = 0,08-10 mm<sup>2</sup>, working range 2 = 16 mm<sup>2</sup>).

### Crimping tools for cable end sleeves

acc. to DIN 46228 page 1 and 4



05184

12648/12649

Part-No.	cross-section range		description	length	weight kg/pcs.
12648	Single	10 - 25 mm <sup>2</sup>	Crimping tool with ratchet and double W-crimping	260 mm	0,63
12649	Single	35 - 50 mm <sup>2</sup>	Crimping tool with ratchet and double W-crimping	260 mm	0,63
	Twin	16 mm <sup>2</sup>			
05184	Single	10 - 50 mm <sup>2</sup>	Crimping tool with ratchet and trapezoid crimping	300 mm	0,60

**Remark:** Part-No. 12648/12649 high quality crimping tools with optimized power gear ratio enable fatigue proof work also when working with bigger cross-sections.  
 Part-No. 05184 universal tool with a wide cross-section range and a good ratio in price and performance. Five crimping profiles with ferrule insertion from the side.

### Multifunction crimping tool Quadro

for insulated cable end sleeves in stripform design



12510



12512

Only one tool  
for  
4 in 1

1. Cutting
2. Stripping
3. Twisting
4. Crimping

Part-No.	cross-section range	description
12510	0,5 - 2,5 mm <sup>2</sup>	Quadro-Set consisting out of Quadro-tool, 3 magazine, 1 case for cable end sleeves, 1 tool-case
12512	0,5 - 2,5 mm <sup>2</sup>	Quadro without magazine and without tool-case
12514		Replacement magazine for Quadro

**Remark:** Only one tool for cutting and stripping of leadings, twisting of the wire strands and crimping of insulated cable end sleeves in stripform design according catalogue page 69. Quick change sleeve magazine enables an easy and ergonomic work in a very short time.

## 2. CUTTING-, STRIPPING AND CRIMPING TOOLS

### 2.4 Hand operated tools, multifunction tools as well as machines suitable for crimping insulated and uninsulated cable lugs and connectors

Electrical connections or wiring operations are normally done by using prefabricated leadings with crimped cable lugs or connectors.

The requirements of such connections are in dependence of the used cable lugs or connectors regulated in different norms. Some information are specified in the technical appendix of this catalogue on page 205. The technical regulation give us information about the necessary mechanical as well as electrical characteristics of crimp connections. Generally crimp connections must be done in a way that no unacceptable heating resp. unacceptable increasing of the resistance take place. So a solderless crimp connection is defined as a non detachably electrical and mechanical connection between a conductor and a cable lug or connector. The process includes a malleable permanent material deforming.

To fulfill the requirements in dependence of the frequency of use, druseidt offers tools or machines in different levels of price and performance.

The different druseidt multifunction tools with exchangeable die-sets offer the possibility to crimp various kinds of connectors by using only one tool. Especially they are well suited for mobile application or repair works or in all other cases where no serial-production is required.

**We deliver shortly from our stock:**

- Hand operated tools for crimping different cable lugs and connectors
- Multifunction tools with exchangeable die-sets
- Pneumatically or electrically operated crimp machines with exchangeable die-sets
- Thus we are in a position to offer solutions for nearly every use case





**Crimping tools for insulated cable lugs and connectors**



05103



12600/N



12601

Part-No.	cross-section range	description	length	weight kg/pcs.
05103	0,1 - 0,5 mm <sup>2</sup>	Crimping tool with ratchet	170 mm	0,32
12600/N	0,5 - 6 mm <sup>2</sup>	Crimping tool with ratchet and double crimping	230 mm	0,53
12601	0,5 - 6 mm <sup>2</sup>	Crimping tool with ratchet and double crimping	260 mm	0,62

**Remark:** Part-No. 05103 simply tool for insulated and uninsulated "Mini" cable lugs 0,1-0,5 mm<sup>2</sup>.

**Part-No. 12600/N** Handy tool with a good ratio in price and performance. Well suited for installation works.

**Part-No. 12601** High quality crimping tool with an excellent power gear ratio. Applicable also for continuous works in small series.



05180



05186



12602

Part-No.	cross-section range	description	length	weight kg/pcs.
05180	0,5 - 6 mm <sup>2</sup>	Crimping tool with ratchet and double crimping	220 mm	0,48
05186	Stripping and cutting unit 0,5-6 mm <sup>2</sup> for 05180			
12602	10 - 16 mm <sup>2</sup>	Crimping tool with ratchet	245 mm	0,48

**information:** Part-No. 05180 Universal tool with a good ratio in price and performance. As an accessory the stripping and cutting clip Part-No. 05186 can be mounted in the handles. Part-No. 12602 simply tool for cross-section range 10 + 16 mm<sup>2</sup>.



**Profi Crimp Set**

with 5 pcs. exchangeable die sets  
in a handy plastic suitcase



Part-No.	content/scope of supply	
<b>12858</b>	<ul style="list-style-type: none"> <li>- Basic tool</li> <li>- Die set for cable end sleeves 0,5-16 mm<sup>2</sup></li> <li>- Die set for insulated cable lugs 0,5-6 mm<sup>2</sup></li> <li>- Die set for uninsulated cable lugs 0,5-10 mm<sup>2</sup></li> <li>- Die set for crimping connectors 0,5-6 mm<sup>2</sup></li> </ul>	<ul style="list-style-type: none"> <li>- Die set for BNC/TNC connectors</li> <li>- RG 55, 58, 59, 62 174, 8279 and others LWL (hexagonal 6,48 - 5,4 - 4,76 - 1,72)</li> <li>- Screw-driver with screws</li> <li>- Plastic suitcase</li> </ul>

**Remark:** Well suited for service works in industry and industrial art. Tool in handy design with 5 die sets for the most usual applications in a handy tool-case.

**Mobile crimping tool**

with exchangeable die-sets



Part-No.	description	length	weight kg/pcs.
<b>05160</b>	Basic tool with ratchet	460 mm	0,46
<b>Deliverable die sets</b>			
<b>05161</b>	Die set for insulated cable lugs 0,5-2,5 mm <sup>2</sup>		
<b>05162</b>	Die set for insulated cable lugs 0,1-0,5 and 6 mm <sup>2</sup>		
<b>05163</b>	Die set for cable lugs DIN 46234 0,5-6 mm <sup>2</sup>		
<b>05164</b>	Die set for cable lugs DIN 46234 4-10 mm <sup>2</sup>		
<b>05165</b>	Die set for cable end sleeves 0,25-10 mm <sup>2</sup>		
<b>05166</b>	Die set for cable end sleeves 16-25 mm <sup>2</sup>		
<b>05167</b>	Die set for cable end sleeves 35-50 mm <sup>2</sup>		
<b>05168</b>	Die set for coax cable RG 58/59/62/71		
<b>05169</b>	Die set for machined pin and socket contacts 0,14-4 mm <sup>2</sup>		
<b>05170</b>	Die set for machined pin and socket contacts 6-10 mm <sup>2</sup>		
<b>05171</b>	Die set for uninsulated tabs and receptacles 2,8 mm		
<b>05172</b>	Die set for uninsulated tabs and receptacles 4,8 mm		
<b>05173</b>	Die set for uninsulated tabs and receptacles 6,3 mm		
<b>05174</b>	Die set for solar connectors MC3		
<b>05175</b>	Die set for solar connectors MC4		
<b>05176</b>	Die set for solar connectors Tyco Solarlok		

**Remark:** Universal crimping tool with a multiplicity selection of die sets. The parallel stroke mechanism guaranteed high quality crimping connections. The different die sets have been connected by a pin and are easy and quick exchangeable. To protect them while stored we'll deliver the dies in little plastic boxes. The user-friendly design combined with the extensive number of die sets realize a flexible working by using only one basic tool.

## Solar-Kit



Part-No.	content/scope of supply
05178	1 Piece Crimping tool with ratchet 05160 without die sets 1 Piece Die set for solar connector MC 3 1 Piece Die set for solar connector MC 4 1 Piece Die set for solar connector Tyco Solarlock 1 Piece Stripping tool for solar cables 2,5-6 mm <sup>2</sup> , adjusted for 7 mm and 8,5 mm stripping length

**Remark:** Special tool kit applicable for the crimping of the most established solar connectors and stripping of solar cables.

## Universal tools

for crimping coax-connectors and uninsulated tabs and receptacles



Part-No.	range of application	description	length	weight kg/pcs.
12855/N	RG 55/58/59/62/71/174/8279 u.a.	Crimping tool with ratchet	230 mm	0,53
05116/N	0,5- 6 mm <sup>2</sup>	Crimping tool with ratchet and double crimpings	230 mm	0,53

**Remark:** **Part-No. 12855/N** Universal crimping tool for BNC- and TNC-connectors, outside-Ø 6,48/5,41/4,76/1,72. Applicable for crimping the inner contact as well as the outer sleeve. **Part-No. 05116/N** Universal crimping tool applicable for the crimping of uninsulated tabs and receptacles.

## Precision crimping tools with linear crimping

for uninsulated tabs and receptacles

### Advantages of the linear crimping process

No twisting of the contacts and symmetric curling of the crimping claws. The linear crimping process offers a machine-like crimping performance and perfect precisioned crimpings for highest demands. The following described tools are equipped with double crimping precision dies and offer a crimping of wire and insulation in one step.

The universal crimping head Part-No. 12620 enables a crimping of a great part of contacts (flat and round terminals etc.) which are on the market. Additionally to the standardized crimping heads it is possible to order special heads for D-Sub-contacts or telephone plugs etc. on request.



Best-Nr.	cross-section range	description
12615	-	basic tool without crimping heads
12616	-	plastic suitcase for basis tool and 5 die sets
12617	0,5 - 1,0 mm <sup>2</sup>	crimping head for uninsulated tabs and receptacles 2,8 mm
12618	0,5 - 1,5 mm <sup>2</sup>	crimping head for uninsulated tabs and receptacles 4,8 mm
12619	0,5 - 2,5 mm <sup>2</sup>	crimping head for uninsulated tabs and receptacles 6,3 mm
12620	0,5 - 2,5 mm <sup>2</sup>	universal crimping head

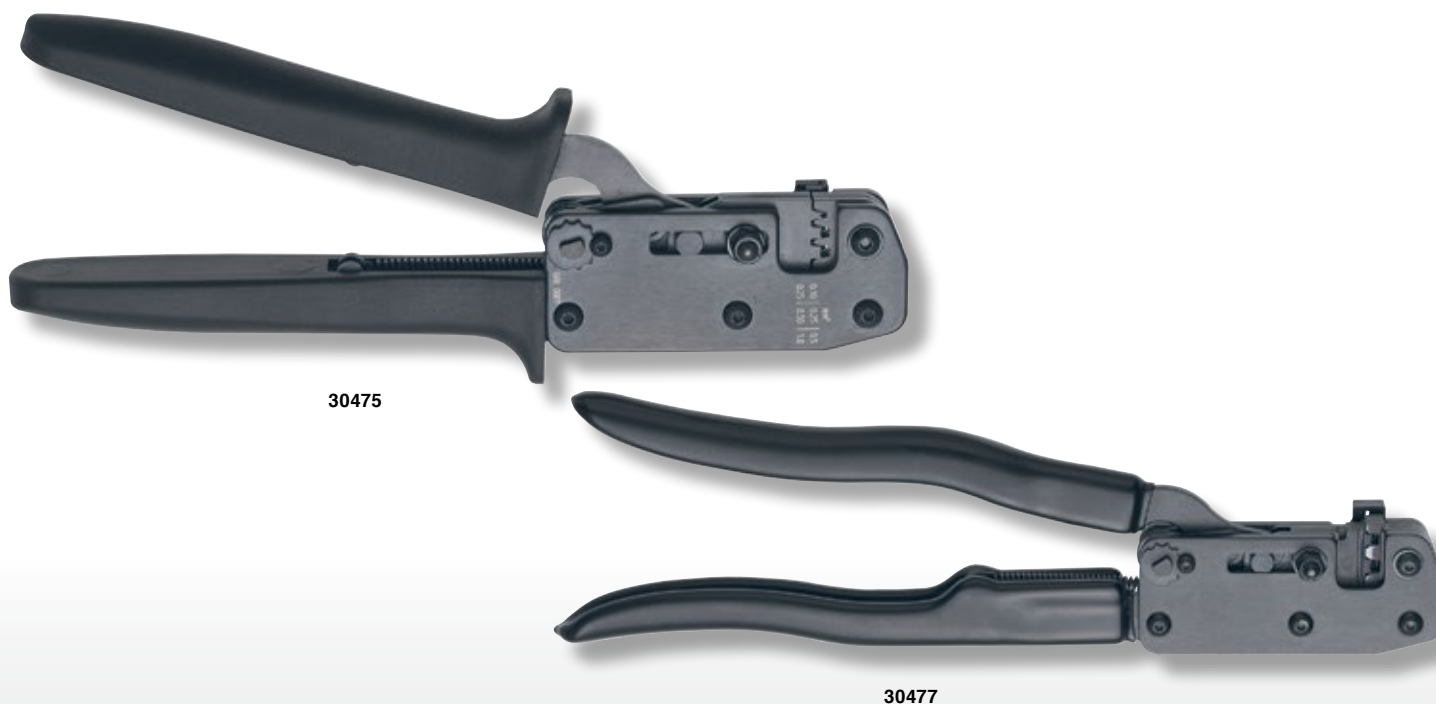

Part-No.	cross-section range	description	length	weight
30475	0,5 - 1,0 mm <sup>2</sup>	for uninsulated tabs and receptacles 2,8 mm	210 mm	0,50 kg
30477	1,0 - 2,5 mm <sup>2</sup>	for uninsulated tabs and receptacles 6,3 mm	350 mm	0,50 kg
30480	0,5 - 1,0 mm <sup>2</sup>	for flag type receptacles Part-No. 04945	210 mm	0,50 kg
30481	0,5 - 1,5 mm <sup>2</sup>	for flag type receptacles Part-No. 04940	210 mm	0,50 kg



## Electromechanically battery operated crimping tool

with exchangeable crimping dies up to 50 mm<sup>2</sup> cross-section

Electromechanical tool with Li-Ion battery in a light and compact design. Precise tap positioning of contacts. With quick stop (no overrun of the tool), emergency unlock and reset function. Process monitoring on multifunction display (battery charge level, service interval display, overheating/overload warning). Short, compact work area. Universal applicable through multiplicity designs of die-sets.

- Low maintenance electromechanical drive with Li-Ion-battery technology
- Light and handy tool with automatic sequence control
- Combinable with a multiplicity of number of die-sets in standard-design
- Cycle monitoring on multifunction display and motor quick-stop for guaranteed process safety
- LED illuminated work area
- Ergonomic working height and low noise level



Part-No.	Cross-section range mm <sup>2</sup>	Description/Scope of supply
12230	0,10 - 50,0	1 standard set consisting out of: 1 pcs. crimping tool without die-sets 1 pcs. Li-Ion-battery 12 V/1,5 Ah 1 pcs. battery charger 230 V 1 pcs. plastic case with inlet
<b>Accessories</b>		
12231		1 pcs. Li-Ion battery 12 V/1,5 Ah loading time ca. 30 min.
12232		1 pcs. Li-Ion battery 12 V/3 Ah loading time ca. 60 min.
12233		1 Stck. replacement battery charger 230 V
<b>Technical data</b>		
• Cross-section range 0,10-50 mm <sup>2</sup>	• Li-Ion battery 12 V 1,5 Ah or 3 Ah	
• Crimping force 15 kN	• Dimensions (L x W x H) 142 x 50 x 274 mm	
• Crimping-cycle ca. 2,5 sec.	• Weight 2 kg	
<b>Remark:</b> If necessary we deliver the tools also with battery charger for UK, USA or Oceania/Australia.		



## Deliverable crimping dies for electromechanically battery operated crimping tool Part-No. 12230

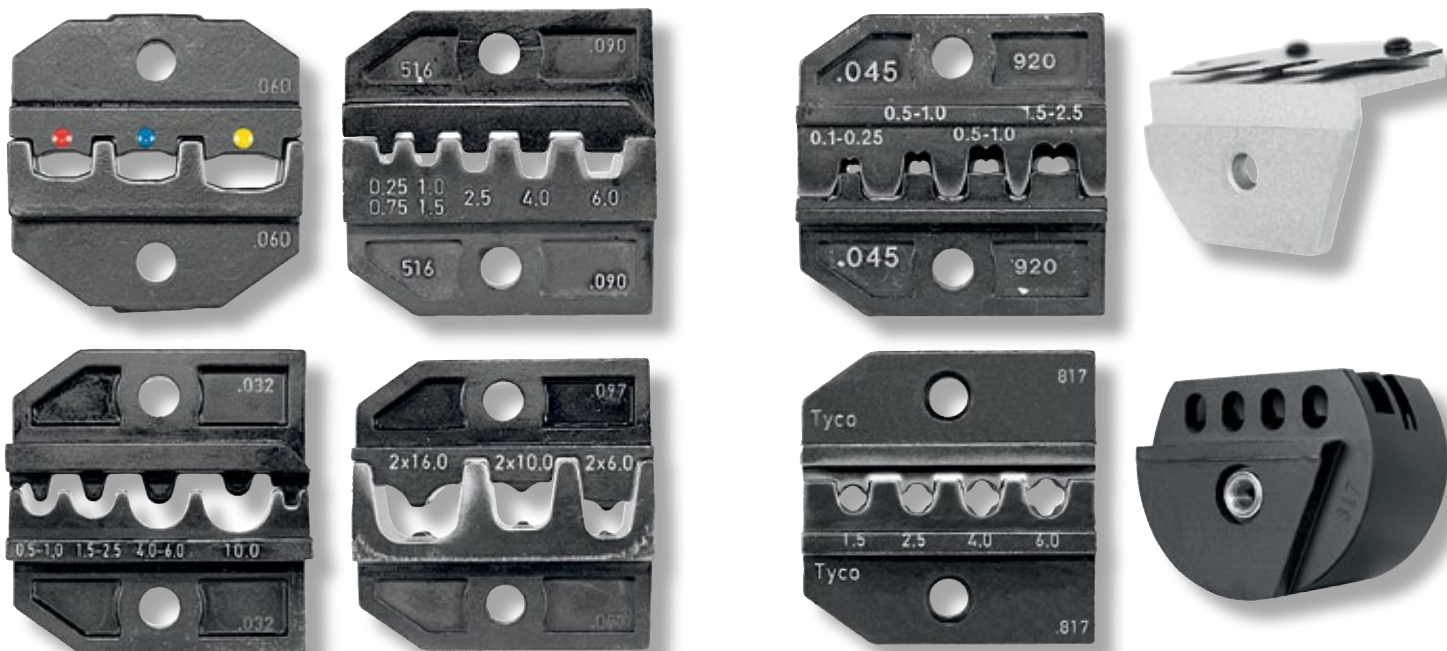

Exchangeable crimping dies

Crimping dies with locator

Part-No.	cross-section-range mm <sup>2</sup>	Description
12240	0,5 - 6	For insulated cable lugs and connectors
12241	10 - 16	For insulated cable lugs and connectors
12242	0,5 - 10	For cable lugs DIN 46234
12243	16 - 25	For cable lugs DIN 46234
12244	1,5 - 10	Universal die set for uninsulated butt connectrs usual in trade design 1,5/2,5 + 4 mm <sup>2</sup> druseidt Part-No. 13687/13688 und 13689 as well as connectors acc. to DIN 46267 part 1 6 + 10 mm <sup>2</sup> druseidt Part-No. 01964/65
12245	0,25 - 6	For uninsulated and insulated cable end sleeves DIN 46228 page 1 + 4
12246	10 - 25	For uninsulated and insulated cable end sleeves DIN 46228 page 1 + 4
12247	35 - 50	For uninsulated and insulated cable end sleeves DIN 46228 page 1 + 4
12248	2 x 6 - 2 x 16	For insulated TWIN cable end sleeves
12249	0,1 - 2,5	For uninsulated receptacles 2,8 mm and 4,8 mm
12249/A		Locator for die set Part-No. 12249
12250	0,5 - 6	For uninsulated receptacles 4,8 und 6,3 mm
12250/A		Locator for die set Part-No. 12250
12239	0,5 - 6	For uninsulated ring terminals DIN 46225 design A
12251	-	For coaxial connectors RG 58/59 and RG 62/71, crimp dimensions 5,4/6,48/1,72 mm
12258	2,5 - 6	For solar connectors MC 4
12258/A		Locator for die set Part-Nr. 12258
12252	4 - 10	Für solar connectors MC 4
12252/A		Locator for die set Part-No. 12252
12259	2,5 - 6	For solar connectors MC 3
12259/A		Locator for die set Part-No. 12259
12265	4 - 10	For solar connectors MC 3
12265/A		Locator for die set Part-No. 12265
12269	1,5 - 6	For solar connectors Tyco
12269/A		Locator for die-set Part-No. 12269
12253	0,14 - 4	For turned pin- and socket contacts
12253/A		Locator for die set Part-No. 12253
12235	1,5 - 6	For turned pin- and socket contacts
12235/A		Locator for die set Part-No. 12235
12236	4 - 10	For turned pin- and socket contacts
12236/A		Locator for die set Part-No. 12236
12237	10 + 16	For turned pin- and socket contacts incl. locator
12238	6 + 25	For turned pin- and socket contacts incl. locator
12224	-	For Western jacks 4-, 6-, 8-pin
12225	-	For short Molex jacks 4-, 6-, 8-pin
12226	-	For Stewart plugs 4-, 6-, 8-pin

## Multifunctional crimping devices

deliverable as hand operated tool and electrically or pneumatically operated machines

The offered tool 12430 as well as the machines 12408 and 12425 works with the same die sets. The high and constant quality of the crimping performance is the result of the dies combined by the linear crimping process. The machines were created with a newly developed safety mechanism. Consequently there is no need to specify any safety covers to protect the operator. Two sizes of stabilized tool-cases for the hand operated tool offer the possibility to work with and to store a different number of die sets.

When working with the hand tool in combination with a machine the system enables a stationary as well as working inside of switch gears or switch boxes. The electrically operated machine part-no. 12408 is characterized by an easy and quick exchange of the tool head and die sets in a short machine cycle time. It is possible to crimp the connectors in one as well as in two steps.

The machine is equipped with an adjustable double step mechanism. That means that the crimping contact will be fixed in the first and the crimping procedure and the reverse of the dies will be done in the second step. Activation with safety foot pedal. Assembling of all offered die sets in the fast-change-clamp of the tool head part-no. 12409.

So the system offers a cost-effective as well as a working in a wide range of application.



table top unit

foot pedal

Part-No.	description	dimensions mm			weight kg/pcs.
		B	L	H	
<b>Hand operated tool</b>					
12430	basic tool without die set	75	220	40	0,58
12431	plastic tool-case for basic tool and 5 die sets				
12432	plastic tool-case for basic tool and 13 die sets				
<b>Electrically operated machine</b>					
12408/N	crimping machine 230 V AC with safety foot pedal without tool head and crimping dies	390	260	200	13,00
12409/N	basic crimping head without crimping dies				

Description of the die sets on page 159.

## Pneumatically operated safety crimping machine

These pneumatically operated crimping machine needs, just as the electrically one, no safety covers to protect the operator. The machine was created with the newly developed and patent protected safety mechanism. By means of a fitted safety valve, crimping is not released where the size of the opening between the impact surfaces of the dies exceeds 5,9 mm. Consequently there is no need to specify any safety covers. Activation with safety double foot pedal is standard.

So the productivity is additionally increased and the hands of the operator remain free to insert the contacts and conductors. Crimp force starting at 9 kN and exponentially increasing to max. 120 kN at die closure at 6 bar. Electronic piece counter, safety double foot pedal, a colour coded quadruple connecting hose and a tool-mounting-set are standard and scope of delivery. The multiplicity fields of applications offer a wide range of crimping activities.



foot pedal

table top unit

Part-No.	cross-section range mm <sup>2</sup>	description	dimensions mm			weight kg/pcs.
			B	L	H	
12425		pneumatically operated crimping machine with tool-adaptor and safety double foot pedal	280	160	280	26,00
<b>Deliverable die sets for hand operated tool 12430 electrically operated machine 12408 and pneumatically operated machine 12425</b>						
12433	0,5 - 6,0	die set for insulated lugs/connectors				
12434	0,1 - 10,0	die set for cable lugs DIN 46234				
12445	10,0	die set for cable lugs DIN 46234				
12447	16,0	die set for cable lugs DIN 46234				
12436	0,14 - 10,0	die set for cable end sleeves DIN 46228 page 1 + 4				
12426	10,0 - 25,0	die set for cable end sleeves DIN 46228 page 1 + 4				
12427	35,0 - 50,0	die set for cable end sleeves DIN 46228 page 1 + 4				
12437	0,5 - 1,0	die set for uninsulated receptacles 2,8 mm				
12438	0,5 - 2,5	die set for uninsulated receptacles 4,8 mm				
12439	0,5 - 6,0	die set for uninsulated receptacles 6,3 mm				

Additional die sets e.g. for solar connectors, machined pin and socket connectors etc. on request.

**Crimping tools for uninsulated cable lugs and connectors**



05103



12645/N



30445

Part-No.	cross-section range mm <sup>2</sup>	description	length	weight kg/pcs.
05103	0,10 - 0,5	crimping tool with ratchet	170 mm	0,32
12645/N	0,50 - 10,0	crimping tool with ratchet	230 mm	0,53
30445	0,75 - 10,0	crimping tool with ratchet	270 mm	0,50

**Remark:** Part-No. 05103 simply tool for insulated and uninsulated "Mini" cable lugs 0,1-0,5 mm<sup>2</sup>. Part-No. 12645 N/30445 universal tools, well suited for installation works.



05182



05186



30446



05126

Part-No.	cross-section range mm <sup>2</sup>	description	length	weight kg/pcs.
05182	0,1 - 16	crimping tool with ratchet	220 mm	0,47
05186		stripping and cutting unit 0,5-6 mm <sup>2</sup> for 05182		
30446	1,5 - 16	crimping tool with ratchet	315 mm	0,61
05126	10,0 - 25	crimping tool with ratchet	260 mm	0,62

**Remark:** All tools for crimping cable lugs according to DIN 46234, 46230 resp. connectors DIN 46341 Part 1 design A + B or connectors with similar dimensions. Part-No. 05182 as an accessory the stripping and cutting clip Part-No. 05186 can be mounted in the handles.



## Crimping tools for tubular cable lugs and connectors in druseidt standard design

crimping width 5 mm



12375



12376



12377

Part-No.	cross-section range mm <sup>2</sup>	crimping design	length	weight kg/pcs.
12375	6 - 50	WM-crimping	380 mm	1,30
12376	6 - 70	WM-crimping	515 mm	2,00
12377	10 - 120	WM-crimping	660 mm	4,10

**Remark:** Suitable for crimping of druseidt standardized tubular cable lugs and connectors according to the catalogue pages 30-34. The cross-section can be adjusted by turning the in-built-revolving dies. So there is no need of changing dies.

## Crimping tools for tubular cable lugs and connectors in druseidt Euro-type design

crimping width 5 mm



12372/50



12372



12373

Part-No.	cross-section range mm <sup>2</sup>	crimping design	length	weight kg/pcs.
12372/50	6 - 50	WM-crimping	380 mm	1,30
12372	6 - 70	WM-crimping	515 mm	2,00
12373	10 - 120	WM-crimping	660 mm	4,10

**Remark:** Suitable for crimping of tubular cable lugs and connectors in druseidt Euro-type design according to the catalogue pages 42-48. The cross-section can be adjusted by turning the in-built-revolving dies. So there is no need of changing dies.

### Crimping tool for tubular cable lugs in druseidt design for fine stranded cables

crimping width 5 mm



12370/50



12370/12374



12371

Part-No.	cross-section range		crimping design	lengths	weight kg/pcs.
	Copper	Alu			
<b>For tubular cable lugs and connectors druseidt design for fine stranded cables</b>					
12374	10 - 70 mm <sup>2</sup>	-	WM-crimping	515 mm	2,18
<b>For tubular cable lugs an connectors out of copper according to DIN 46235/DIN 46267 Part 1 / Aluminium DIN 46329/DIN 46267 Part 2</b>					
12370/50	6 - 50 mm <sup>2</sup>	10 - 35 mm <sup>2</sup>	hexagonal crimping	380 mm	1,30
12370	6 - 70 mm <sup>2</sup>	10 - 50 mm <sup>2</sup>	hexagonal crimping	515 mm	2,00
12371	10 - 120 mm <sup>2</sup>	10 - 70 mm <sup>2</sup>	hexagonal crimping	660 mm	4,10

**Remark:** Suitable for crimping of cable lugs and connectors in druseidt design for fine stranded cables acc. to catalogue pages 36-39 (Part-No. 12374) resp. 50-53 and 56-59 (Part-No. 12370/50-12371). The cross-section can be adjusted by turning the in-built-revolving dies. So there is no need of changing dies.

### Mechanical hand operated crimping tool with telescopic handles and exchangeable crimping dies 1,5 up to 240 mm<sup>2</sup>



**druseidt-system-dies size II**  
(half shell dies in small design)

Part-No.	cross-section range			crimping design	lengths (retracted/extended)	weight kg/pcs.
	Copper	Alu	Stainless steel			
12869	6 - 240 mm <sup>2</sup>	16 - 185 mm <sup>2</sup>	1,5 - 35 mm <sup>2</sup>	Various	550/770 mm	3,30

**Remark:** Universal applicable hand operated mechanical crimping tool. Designed for using druseidt system die sets size II (half shell dies in small design). Wide range of application for conductor cross-section up to 240 mm<sup>2</sup>. Quick changing of die sets by foldable crimping head with quick release. 360° rotatable crimping head. The telescopic handles and the relatively low weight enable an fatigue-free work.

### Range of application/deliverable crimping dies

- **Indent crimping 10-70 mm<sup>2</sup>**  
for cable lugs DIN 46234 + DIN 46230
- **Indent crimping 1,5-35 mm<sup>2</sup>**  
for druseidt stainless steel cable lugs
- **WM-crimping 10-240 mm<sup>2</sup>**  
for tubular cable lugs and connectors  
- druseidt standard desin  
- druseidt Euro-type design
- **WM-crimping 10-185 mm<sup>2</sup>**  
for druseidt tubular cable lugs and connectors  
- druseidt design for fine stranded cables
- **Hexagonal crimping 6-185/240 mm<sup>2</sup>**  
For cable lugs and connectors  
- Copper DIN 46235/DIN 46267 part 1  
- Aluminium DIN 46329/DIN 46267 part 2
- **Round crimping dies 25/35-185/240 mm<sup>2</sup>**
- **Trapezoid crimping 10-240 mm<sup>2</sup>**  
for cable end sleeves DIN 46228 part 1 + 4
- **Trapezoid crimping 4-16 mm<sup>2</sup>**  
for Twin cable end sleeves 2 x 4 mm<sup>2</sup> up to 2 x 16 mm<sup>2</sup>

Selection charts for crimping dies with Part-No. and description are listed in this catalogue on pages 204 and 205.

## 2. CUTTING-, STRIPPING AND CRIMPING TOOLS

### 2.5 Power-assisted compression tools with exchangeable die-sets

Additionally to the delivering of simply hand operated tools with a power gear ration generated by leverage forces, druseidt offers various kinds of power-assisted compression tools too. Such tools offer significant advantages, mainly when working under cramped conditions or serial production. In dependence of the frequency of use, the operating conditions and the design of the cable lugs, the user can select out of the following tools:

- Hand operated compression tools with ratchet**  
 The press capacity and crimping depth of such tools are generated by a smooth-running and precise rotating eccentric construction. Where necessary the free movement is guaranteed through a construction with roller- and needle bearings. So the terminals can be crimped very easily by swinging the movable hand lever of the tools.
- Hand operated hydraulic compression tools**  
 The crimping process can be activated by swinging the movable hand lever of the tools. The power gear ration will be realized by a single- or double piston pump.
- Battery operated electro-hydraulic compression tools**  
 When working with such tools the power gear ratio will be realized by an electro-hydraulic aggregate. So a fatigue proof working is guaranteed. While working with batteries the tools are well suited for mobile application.
- Hydraulic working systems with exchangeable compression heads**  
 Such systems consist out of a basic pump or electrohydraulic unit which can be equipped with exchangeable compression- or cutting heads. Caused by the deliverable different cutting- and compression heads the systems are suited for universal as well as mobile application.

In the range of hydraulic operated tools druseidt works as far as possible with exchangeable compression die-systems, that means that you can use the same dies inside of the hand- as well as battery- or electro-hydraulic operated tools.

#### druseidt-system dies

applicable inside of hand- as well as battery- or electrohydraulic operated tools

##### System dies size I

druseidt flat dies



##### System dies size II

druseidt half shell dies in small design



##### System dies Size III

druseidt half shell dies in large design



**Mechanical crimping tool**

with ratchet and revolving dies 6-35 mm<sup>2</sup>  
for cable lugs acc. to DIN 46234

**die set and crimping form**

indent crimping for cable lugs acc. to DIN 46234

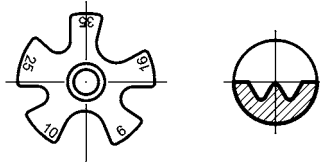

exchangeable die set



exchangeable indenter



Part-No.	cross-section range	crimping force	description	length	weight kg/pcs.
12650	6 - 35 mm <sup>2</sup>	ca. 28 kN	crimping tool with revolving dies	310 mm	1,30
12651	steel carrying case				

**Remark:** Mechanical crimping tool with ratchet suitable for one hand operation. Cable lugs can be crimped very easily by swinging the moveable hand lever. Only one die set is required by crimping cable lugs in a cross-section range 6-35 mm<sup>2</sup>. The construction with the built-in-force-blocking device guaranteed a constant and exact crimping-depth and therefore an excellent electrical and mechanical quality of the crimping connection. The handy design and the collapsible tool head offers also a working in cramped conditions.



## Mechanical crimping tool

with ratchet and exchangeable die sets 6-50 mm<sup>2</sup>



Part-No.	cross-section range	crimping force	description	length	weight kg/pcs.
12655	6 - 50 mm <sup>2</sup>	ca. 28 kN	crimping tool without die sets	280 mm	1,20
12656	steel carrying case				

**Remark:** Mechanical crimping tool with ratchet for one hand operation. Terminals can be crimped very easily by swinging the moveable handle. The construction with the built-in-force-blocking device guaranteed a constant and exact crimping-depth and therefore an excellent electrical and mechanical quality of the crimping connection. The handy design and the collapsible tool head offer also a working in cramped conditions. Exchangeable die sets with different crimping profiles offer an effective working inside of different kinds of applications. The handy design combined with the solid steel carrying case make the tool particularly well suited for working on installations out of your factory.

### Deliverable die sets

#### Indent crimping 6-35 mm<sup>2</sup>

for cable lugs acc. to DIN 46234

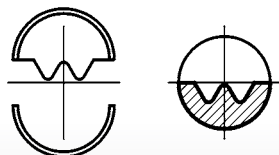

Part-No.	cross-section mm <sup>2</sup>	Part-No.	cross-section mm <sup>2</sup>
12657	6	12660	25
12658	10	12661	35
12659	16	12662	indenter 6 - 35 mm <sup>2</sup>

**Remark:** When placing an order about dies 12657-61 it is necessary to order the indenter 12662

#### WM-crimping 6-50 mm<sup>2</sup>

for tubular cable lugs  
in druseidt standard design

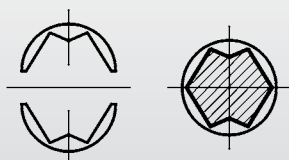

Part-No.	cross-section mm <sup>2</sup>	crimping width mm
12665	6	6
12666	10	6
12667	16	6
12668	25	6
12669	35	6
12670	50	6

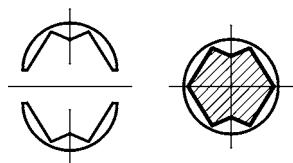
**Exchangeable die sets for crimping tool Part-No. 12655****WM-crimping 6-50 mm<sup>2</sup>**for tubular cable lugs  
druseidt Euro-type design

Part-No.	cross-section mm <sup>2</sup>	crimping width mm
12468	6	5
12469	10	5
12470	16	5
12471	25	5
12472	35	5
12473	50	5

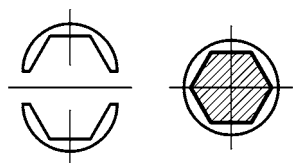
**Hexagonal-crimping 6-50 mm<sup>2</sup>**for copper cable lugs and connectors  
acc. to DIN 46235/46267 part 1

Part-No.	cross-section mm <sup>2</sup>	code-no.	crimping width mm
12671	6	5	5
12672	10	6	5
12673	16	8	5
12674	25	10	5
12675	35	12	5
12676	50	14	5

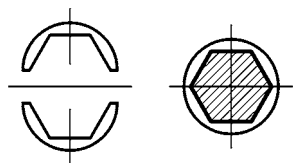
**Hexagonal-crimping 6-50 mm<sup>2</sup>**for aluminium cable lugs and connectors  
acc. to DIN 46329/46267 part 2

Part-No.	cross-section mm <sup>2</sup>	code-no.	crimping width mm
12456	16/25	12 Al	7
12457	35	14 Al	7
12458	50	16 Al	7

**Trapezoid-crimping 6-50 mm<sup>2</sup>**

for cable end sleeves acc. to DIN 46228 page 1 + 4

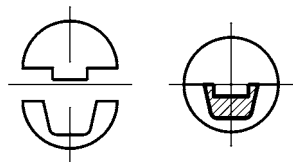

Part-No.	cross-section mm <sup>2</sup>	crimping width mm
12652	6	18
12653	10	18
12654	16	18
12677	25	18
12678	35	18
12679	50	18

**Oval-crimping 10-25 mm<sup>2</sup>**

for insulated cable lugs

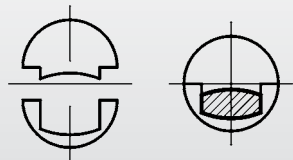

Part-No.	cross-section mm <sup>2</sup>	information
12460	10	suitable for cable lugs
12461	16	acc.to catalogue pages 15 + 16
12462	25	

## Mechanical crimping tool

with ratchet and exchangeable die sets 6-120 mm<sup>2</sup>

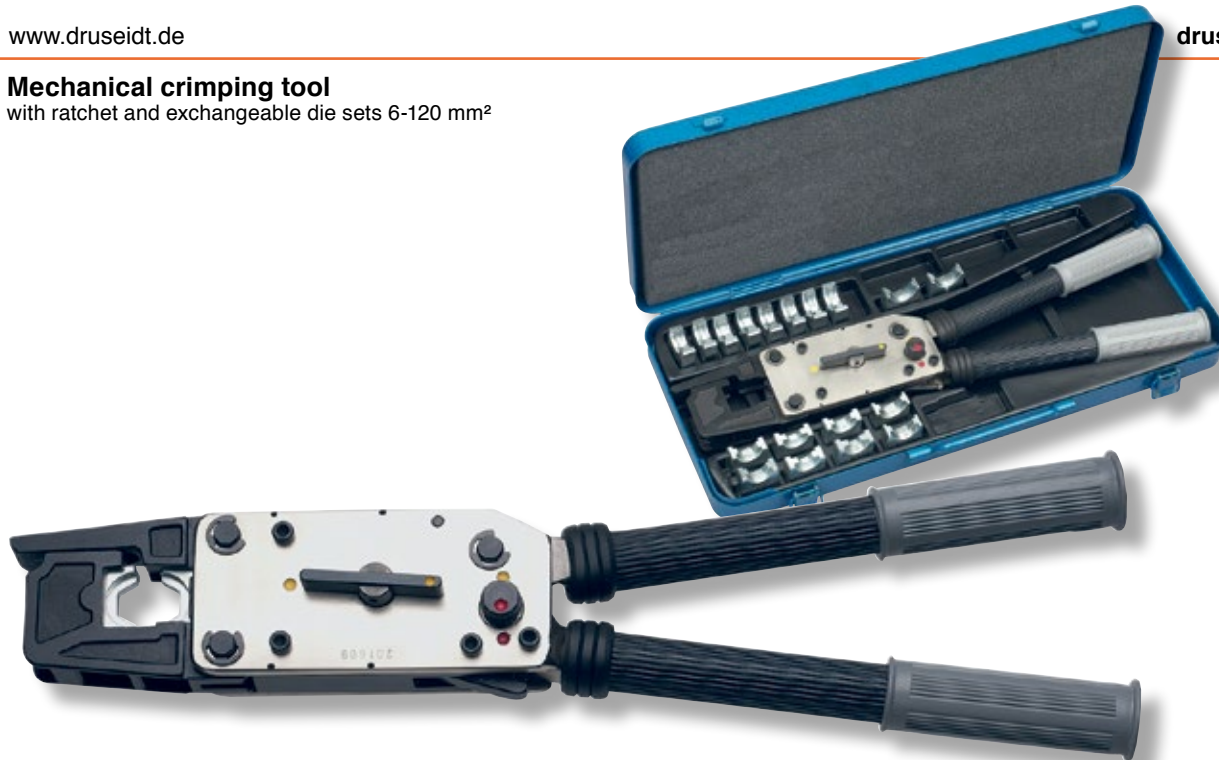

Part-No.	cross-section range	crimping force	description	length	weight kg/pcs.
30460	6 - 120 mm <sup>2</sup>	ca. 55 kN	crimping tool without die sets	430 mm	2,00
30470	steel carrying case				

**Remark:** Handy mechanical crimping tool with ratchet. Terminals can be crimped very easily by swinging the movable handle. The construction with the built-in-force-blocking device guaranteed a constant and exact crimping-depth and therefore an excellent electrical and mechanical quality of the crimping connection. The collapsible tool head enables a quick changing of the die sets. The handy design and the little weight offer also a working in cramped conditions.

## Deliverable die sets

### Indent crimping dies 6-70 mm<sup>2</sup>

for cable lugs acc. to DIN 46234

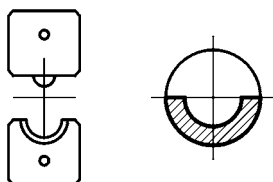

Part-No.	cross-section mm <sup>2</sup>	Part-No.	cross-section mm <sup>2</sup>
12680	10 + 16 + 25 + 35	12683	Indentor 6 - 70
12681	6 + 50		
12682	70		

**Information:** When placing an order about dies 12680-82 it is necessary to order the indentor 12683 too.

### WM-crimping 10-120 mm<sup>2</sup>

for tubular cable lugs  
druseidt standard design

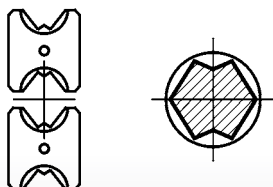

Part-No.	cross-section mm <sup>2</sup>	crimping width mm
12685	10 + 70	7
12686	16 + 35	7
12687	25 + 50	7
12688	95	5,5
12689	120	5,5

### WM-crimping 10-120 mm<sup>2</sup>

for tubular cable lugs  
druseidt Euro-type design

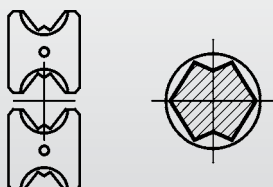

Part-No.	cross-section mm <sup>2</sup>	crimping width mm
12475	10 + 70	7
12476	16 + 35	7
12477	25 + 50	7
12478	95	5,5
12479	120	5,5

**Exchangeable die sets for crimping tool Part-No. 30460**
**WM-crimping 10f-95f mm<sup>2</sup>**

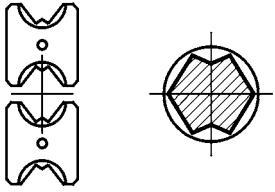
 for tubular cable lugs  
 druseidt design for fine stranded cables

Part-No.	cross-section mm <sup>2</sup>	crimping width mm
12515	10 f + 25 f	5
12516	16 f + 35 f	5
12517	50 f	5
12518	70 f	5
12519	95 f	5

**Hexagonal-crimping 10-120 mm<sup>2</sup>**

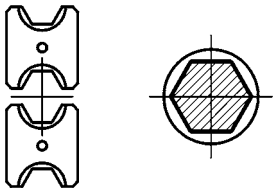
 for copper cable lugs and connectors  
 acc. to DIN 46235/46267 part 1

Part-No.	cross-section mm <sup>2</sup>	code-no.	crimping width mm
12690	10 + 70	6 + 16	5,5
12691	16 + 35	8 + 12	5,5
12692	25 + 50	10 + 14	5,5
12693	95	18	5,5
12694	120	20	5,5

**Hexagonal-crimping 16-95 mm<sup>2</sup>**

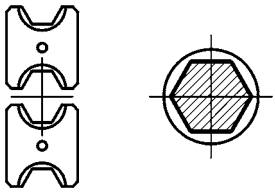
 for aluminium cable lugs and connectors  
 acc. to DIN 46329/46267 part 2

Part-No.	cross-section mm <sup>2</sup>	code-no.	crimping width mm
12762	16/25 + 35	12 Al + 14 Al	7
12763	16/25 + 50	12 Al + 16 Al	7
12764	70	18 Al	7
12765	95	20 Al	7

**Trapezoid-crimping 25-95 mm<sup>2</sup>**

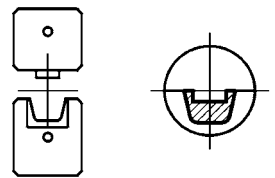
 for cable end sleeves  
 acc. to DIN 46228 page 1 + 4

Part-No.	cross-section mm <sup>2</sup>	pressing width mm	information
12390	25	26	When placing an order about dies 12390-94 it is necessary to order the suitable indenter.
12391	35	26	
12392	50	26	
12393	70	26	
12394	95	26	
<b>Indentor</b>			
12395	25 + 35	26	
12396	50 + 70	26	
12397	95	26	

**Oval-crimping 10-35 mm<sup>2</sup>**

for insulated cable lugs

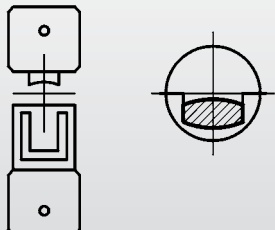

Part-No.	cross-section mm <sup>2</sup>	information
12695	10	For use with cable lugs acc. catalogue pages 15 + 16.
12696	16	
12697	25	
12698	35	



## Mechanical crimping tool

with ratchet  
and exchangeable die sets 10-240 mm<sup>2</sup>

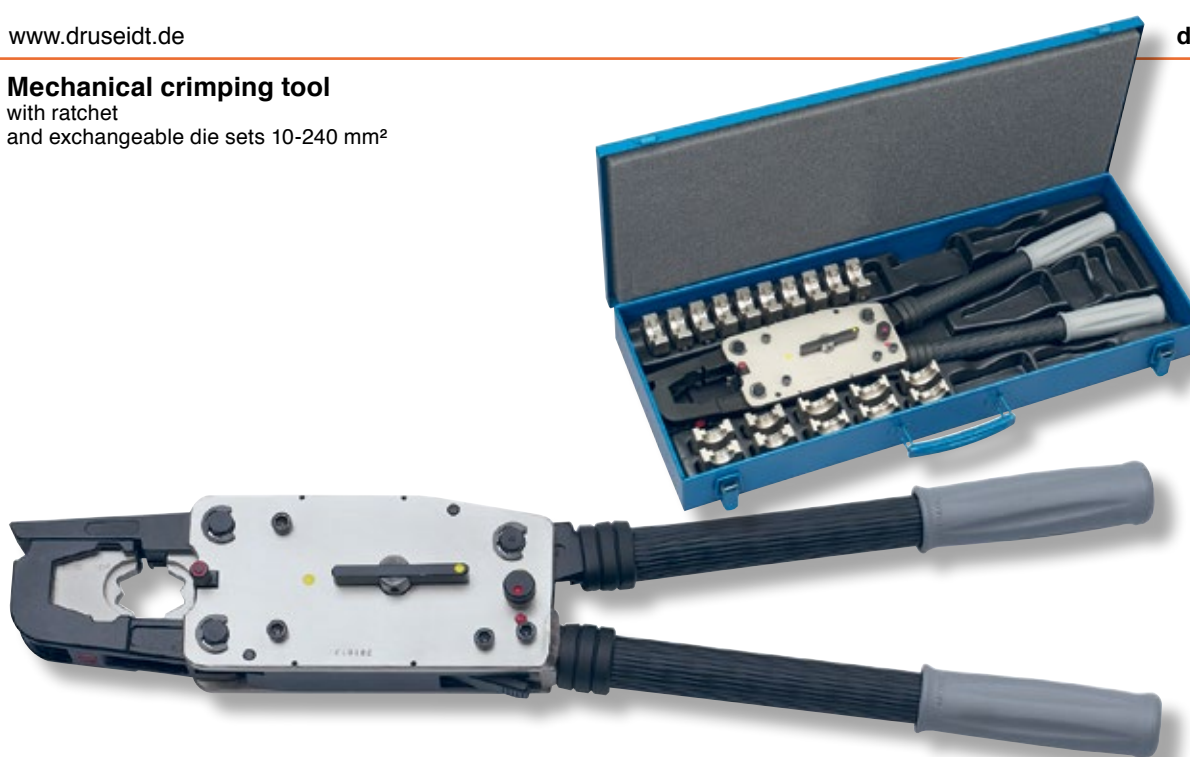

Part-No.	cross-section range	crimping force	description	length	weight kg/pcs.
31460	10 - 240 mm <sup>2</sup>	ca. 100 kN	crimping tool without die sets	565 mm	4,00
31465	Steel carrying case				

**Remark:** Robust mechanical crimping tool with ratchet. Terminals can be crimped very easily by swinging the movable handle. The construction with the built-in-force-blocking device guaranteed a constant and exact crimping depth and therefore an excellent electrical and mechanical quality of the crimping connection. The collapsible tool head enables a quick changing of the die sets. Caused by the crimping force of 100 kN the construction offers an alternative to hydraulic operated tools.

## Deliverable die sets

### Indent-crimping dies 10-150 mm<sup>2</sup>

for cable lugs acc. to DIN 46234

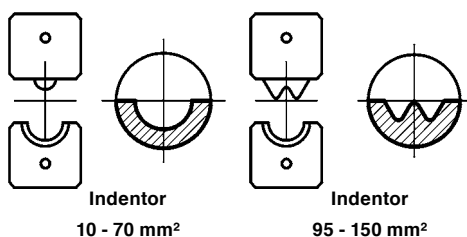

Part-No.	cross-section mm <sup>2</sup>	Part-No.	cross-section mm <sup>2</sup>
12800	10 + 70	12804	95
12801	16 + 35	12805	120
12802	25 + 50	12806	150
12803	Indenter 10 - 70	12807	Indenter 95 - 150

**Remark:** When placing an order about indent crimping dies Part-No. 12800-02 and 12804-06 it is necessary to order the suitable indenter too.

### WM-crimping 10-240 mm<sup>2</sup>

for tubular cable lugs  
druseidt standard design

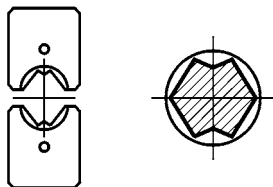

Part-No.	cross-section mm <sup>2</sup>	crimping width mm	Part-No.	cross-section mm <sup>2</sup>	crimping width mm
12341	10	7	12347	95	7
12342	16	7	12348	120	7
12343	25	7	12349	150	7
12344	35	7	12350	185	7
12345	50	7	12351	240	7
12346	70	7			

### WM-crimping 10-240 mm<sup>2</sup>

for tubular cable lugs  
druseidt Euro-type design

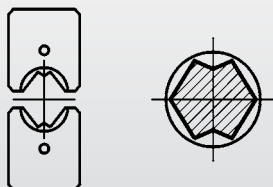

Part-No.	cross-section mm <sup>2</sup>	crimping width mm	Part-No.	cross-section mm <sup>2</sup>	crimping width mm
12562	10	7	12568	95	7
12563	16	7	12569	120	7
12564	25	7	12570	150	7
12565	35	7	12571	185	7
12566	50	7	12572	240	7
12567	70	7			

**Exchangeable die sets for crimping tool Part-No. 31460**
**WM-crimping 10f-150f mm<sup>2</sup>**

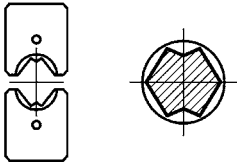
 for tubular cable lugs  
 druseidt design for fine stranded cables

Part-No.	cross-section mm <sup>2</sup>	crimping width mm	Part-No.	cross-section mm <sup>2</sup>	crimping width mm
12192	10 f	5	12197	70 f	5
12193	16 f	5	12198	95 f	5
12194	25 f	5	12199	120 f	5
12195	35 f	5	12200	150 f	5
12196	50 f	5			

**Hexagonal-crimping 10-240 mm<sup>2</sup>**

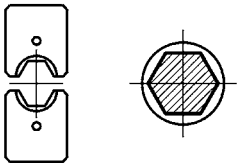
 for copper-cable lugs and connectors  
 acc. to DIN 46235/46267 part 1

Part-No.	cross-section mm <sup>2</sup>	code-no.	crimping width mm	Part-No.	Quer-schnitt mm <sup>2</sup>	code-no.	crimping width mm
12809	10	6	7	12357	95	18	7
12352	16	8	7	12358	120	20	7
12353	25	10	7	12359	150	22	7
12354	35	12	7	12360	185	25	7
12355	50	14	7	12361	240	28	7
12356	70	16	7				

**Hexagonal-crimping 10-240 mm<sup>2</sup>**

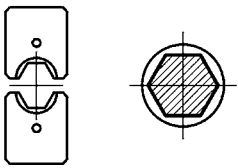
 for aluminium-cable lugs and connectors  
 acc. to DIN 46329/46267 part 2

Part-No.	cross-section mm <sup>2</sup>	code-no.	crimping width mm	Part-No.	Quer-schnitt mm <sup>2</sup>	code-no.	crimping width mm
12362	16/25	12 Al	7	12366	95/120	22 Al	7
12363	35	14 Al	7	12367	150	25 Al	7
12364	50	16 Al	7	12368	185	28 Al	7
12365	70	18 Al	7	12369	240	32 Al	7

**Round-crimping dies 25/35-240/300 mm<sup>2</sup>**

for sector shaped Cu-and Al-conductors

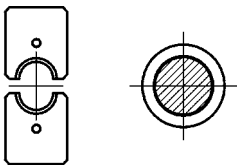

Part-No.	cross-section mm <sup>2</sup>		crimping width mm	Part-No.	cross-section mm <sup>2</sup>		crimping width mm
	sm	se			sm	se	
12378	25	35	25	12383	120	150	25
12379	35	50	25	12384	150	185	25
12380	50	70	25	12385	185	240	25
12381	70	95	25	12386	240	300	16
12382	95	120	25				

**Trapezoid-crimping 25-185 mm<sup>2</sup>**

for cable end sleeves acc. to DIN 46228 part 1 + 4

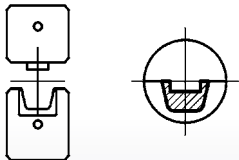

Part-No.	cross-section mm <sup>2</sup>	crimping width mm	Part-No.	cross-section mm <sup>2</sup>	crimping width mm
12888	25	24	12892	95	24
12889	35	24	12893	120	24
12890	50	24			
12891	70	24			

**Oval-crimping 10-150 mm<sup>2</sup>**

for insulated cable lugs

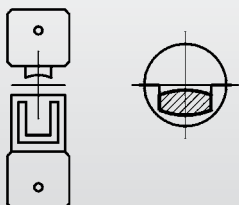

Part-No.	cross-section mm <sup>2</sup>	Part-No.	cross-section mm <sup>2</sup>
12810	10	12815	70
12811	16	12816	95
12812	25	12817	120
12813	35	12818	150
12814	50		

Remark: Suitable for insulated cable lugs according to catalogue pages 15 + 16.

## Hydraulic operated crimping tools

with exchangeable die sets 10-240 mm<sup>2</sup>

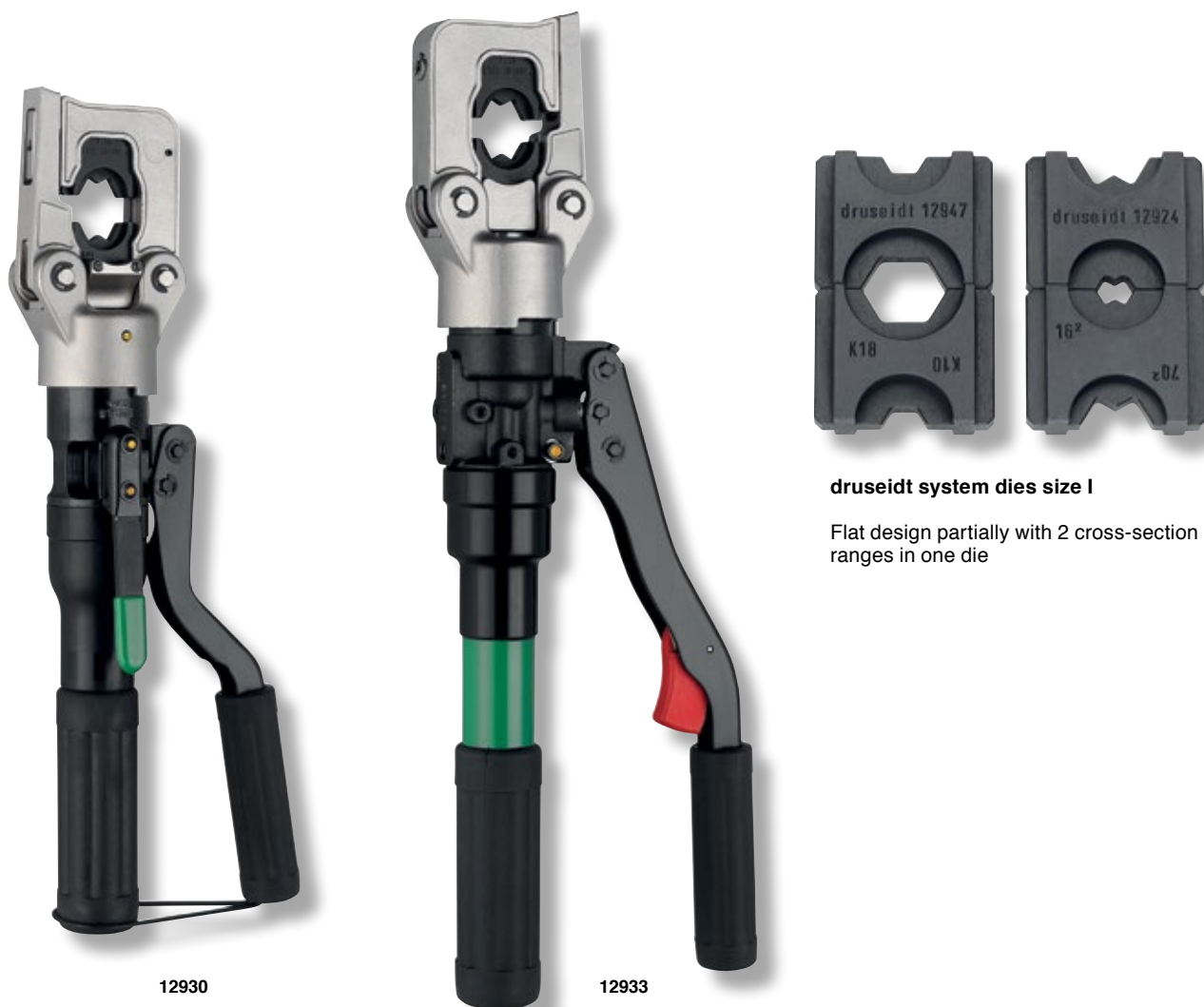

### druseidt system dies size I

Flat design partially with 2 cross-section ranges in one die

Part-No.	cross-section range	crimping force	description	length	weight kg/pcs.
12930	1,5 - 240 mm <sup>2</sup>	ca. 55 kN	crimping tool with single acting piston pump without die sets	365 mm	2,50
12931	steel carrying case for 12930				
12933	1,5 - 240 mm <sup>2</sup>	ca. 55 kN	crimping tool with double acting piston pump without die sets	415 mm	3,30
12934	steel carrying case for 12933				

**Remark:** Small, handy hydraulic operated crimping tools with limit compression valve. Part-No. 12930 with single and Part-No. 12933 with double acting piston pump for rapid motion of the die set to the connector. The collapsible rotating tool head enables a quick changing of the die sets and a working also in cramped conditions. The tools are equipped with druseidt system die sets (flat design acc. to system I), which can be also used in druseidt battery operated tools Part-No. 14240/42, 12748 resp. 12728.

### Range of application/deliverable crimping dies

- **Indent-crimping 6-70 mm<sup>2</sup>**  
for cable lugs acc. to DIN 46234 and 46230
- **Indent-crimping 1,5-35 mm<sup>2</sup>**  
for druseidt stainless steel cable lugs
- **WM-crimping 10-240 mm<sup>2</sup> for tubular cable lugs**
  - druseidt standard design
  - druseidt Euro-type design
  - druseidt design for fine stranded cables
- **Hexagonal-crimping 10/16-185 mm<sup>2</sup>**  
for cable lugs and connectors
  - copper DIN 46235/46267 part 1
  - aluminium DIN 46329/46267 part 2
- **Trapezoid-crimping 10-95 mm<sup>2</sup>**  
for cable end sleeves acc. to DIN 46228 part 1 + 4
- **Round-crimping dies 25/35-185/240 mm<sup>2</sup>**
- **Oval crimping dies 10-35 mm<sup>2</sup>**  
for insulated cable lugs and connectors

Selection charts for crimping dies with Part-No. and description are listed in this catalogue on pages 202 and 203.

## Hydraulic operated crimping tool

with exchangeable die sets 6-300 mm<sup>2</sup>



**druseidt system dies size II**  
half shell dies  
small design

Part-No.	cross-section range	crimping force	description	length	weight kg/pcs.
12766	6 - 300 mm <sup>2</sup>	ca. 62 kN	crimping tool with double acting piston pump without die sets	395 mm	2,80
12767	steel carrying case for 12766				

**Remark:** Handy hydraulic operated crimping tool with a large operating capacity up to cross-section of 300 mm<sup>2</sup>. Equipped with limit compression valve and double acting piston pump for rapid motion of the die set to the connector. The collapsible rotating tool head with quick fastener enables a quick changing of the die sets. The light and handy design with a length of only 395 mm enables also a working in cramped conditions. The tool is equipped with druseidt system die sets (half shell dies, small design acc. to size II) which can be also used in druseidt battery operated tools Part-No. 13552 and 14240/41, 12724 as well as in druseidt hydraulic crimping-heads Part-No. 12836.

### Range of application/deliverable crimping dies

- **Indent crimping 10-70 mm<sup>2</sup>**  
for cable lugs DIN 46234 + DIN 46230
- **Indent crimping 1,5-35 mm<sup>2</sup>**  
for druseidt stainless steel cable lugs
- **WM-crimping 10-300 mm<sup>2</sup>**  
for tubular cable lugs and connectors  
- druseidt standard desin  
- druseidt Euro-type design
- **WM-crimping 10-240 mm<sup>2</sup>**  
for druseidt tubular cable lugs and connectors  
- druseidt design for fine stranded cables
- **Hexagonal crimping 6-300 mm<sup>2</sup>**  
For cable lugs and connectors  
- Copper DIN 46235/DIN 46267 part 1  
- Aluminium DIN 46329/DIN 46267 part 2
- **Round crimping dies 25/35-185/240 mm<sup>2</sup>**
- **Trapezoid crimping 10-240 mm<sup>2</sup>**  
for cble end sleeves DIN 46228 part 1 + 4
- **Trapezoid crimping 4-16 mm<sup>2</sup>**  
for Twin cable end sleeves 2 x 4 mm<sup>2</sup> up to 2 x 16 mm<sup>2</sup>
- **Crimping dies for C- and H-shaped connectors on request**

Selection charts for crimping dies with Part-No. and description are listed in this catalogue on pages 204 and 205.



## Hydraulic operated crimping tools

with exchangeable die sets 10-300 mm<sup>2</sup>



12968



12965/S



druseidt system dies size III  
half shell dies  
large design

Part-No.	cross-section range	crimping force	description	length	weight kg/pcs.
12965/S	10 - 300 mm <sup>2</sup>	ca. 130 kN	crimping tool with single acting piston pump without die sets	570 mm	6,10
12966	steel carrying case for 12965/S				
12968	10 - 300 mm <sup>2</sup>	ca. 130 kN	crimping tool with double acting piston pump without die sets	510 mm	6,10
12969	steel carrying case for 12968				

**Remark:** Hand operated hydraulic crimping tools with high crimping force and rotating C-shaped crimping heads. Part-No. 12965/S with single acting piston pump and adjustable reverse running position. So it is possible to crimp connectors with the same cross-section very quick and economically by realizing the crimping process only with a few strokes. To protect the tool against damaging and pollution it is equipped with completely rubber insulated handles. The C-shaped crimping head enables a side placing of cables and connectors up to 22 mm outside-Ø. Tool Part-No. 12968 is constructed in a shorter design but with a double acting piston pump for rapid motion of the die sets to the connector. The opening of the crimping head enables a side placing of cables and connectors up to an outside-Ø of 25 mm. The high crimping force of both tools realizes a working with crimping dies in a large design. So it is possible to reduce the number of crimpings, when working with bigger cross-sections. The tools are designed for using druseidt system dies size III (half shell dies in large design), which can be also used in druseidt battery operated tools Part-No. 13551/25, 13551/42 and 13537 as well as in druseidt hydraulic crimping heads Part-No. 12485, 12486, 12487 or table top unit 12837.

### Range of application/deliverable crimping dies

- **Indent crimping 10-240 mm<sup>2</sup>**  
for cable lugs DIN 46234 + DIN 46230
- **Indent crimping 10-95 mm<sup>2</sup>**  
for druseidt stainless steel cable lugs
- **WM-crimping 10-300 mm<sup>2</sup>**  
for tubular cable lugs and connectors  
- druseidt standard desin  
- druseidt Euro-type design
- **WM-crimping 10-240 mm<sup>2</sup>**  
for druseidt tubular cable lugs and connectors  
- druseidt design for fine stranded cables
- **Hexagonal crimping 10-300 mm<sup>2</sup>**  
For cable lugs and connectors  
- Copper DIN 46235/DIN 46267 part 1  
- Aluminium DIN 46329/DIN 46267 part 2
- **Round crimping dies 25/35-240/300 mm<sup>2</sup>**
- **Trapezoid crimping 25-185 mm<sup>2</sup>**  
for cble end sleeves DIN 46228 part 1 + 4
- **Crimping dies for C- and H-shaped connectors on request**

Selection charts for crimping dies with Part-No. and description are listed in this catalogue on pages 206 and 207.

**druseidt battery operated tool program:  
Electro-hydraulic operated crimping- and cutting tools  
for industrial as well as applications in craft**

**Economically  
Productive  
Universal applicable**

• **Battery operated tools with fixed tool heads**

- crimping system 60 kN with collapsible tool head
- crimping system 130 kN with C-shaped tool head
- crimping system 130 kN with H-shaped tool head
- cutting system up to 50 mm Ø
- cutting system up to 85 mm Ø

• **Battery operated tools with exchangeable tool-heads**

- crimping/cutting system 60 kN
- crimping/cutting system 100 kN

• **Battery operated tools in cylindrical shaped design**

- druseidt system "Standard"
- druseidt system "Mini"



Battery operated  
crimping tool 130 kN  
with shoulder strap



## Highest quality „made in Germany“

druseidt's battery operated electro-hydraulic crimping and cutting tools offer an excellent solution for mobile applications as well as working in cramped conditions. The new tool generation is characterized by a modern process- and control technology combined and equipped with Li-Ion- batteries and a USB-interface to connect them with all popular PC-systems. The included analysis software allows an interpretation of the crimping process and offers services- and monitoring functions too. Additionally all tools are equipped with an optical failure- and stand-by indication system. So a maximum of performance, safety and controlling is guaranteed.

Especially for switch gear builders who work only in a cross-section range up to 120 mm<sup>2</sup> and do not need so much electronic performances, we offer an extremely handy battery operated crimping tool in cylindrical shape design called "druseidt Mini". This tool offers an economically work in a very good price performance. For applications up to a cross-section range of 240 mm<sup>2</sup> we offer a bigger one called "druseidt Standard". This tool is equipped with the same extensive electronic performances like the tools in pistol-design.



Battery operated crimping/cutting tool 100 kN  
with exchangeable tool heads

Additionally to our product range of crimping and cutting tools in pistol- as well as cylindrical shaped design with fixed tool heads, we deliver systems (crimping/cutting) with exchangeable tool heads too. Especially the tools with the exchangeable tool heads offer an excellent performance in matters of cost effectiveness and mobility.



Battery operated crimping tool 60 kN  
with fixed tool head

**Battery operated hydraulic crimping and cutting tool 60 kN  
druseidt-system with exchangeable tool heads**

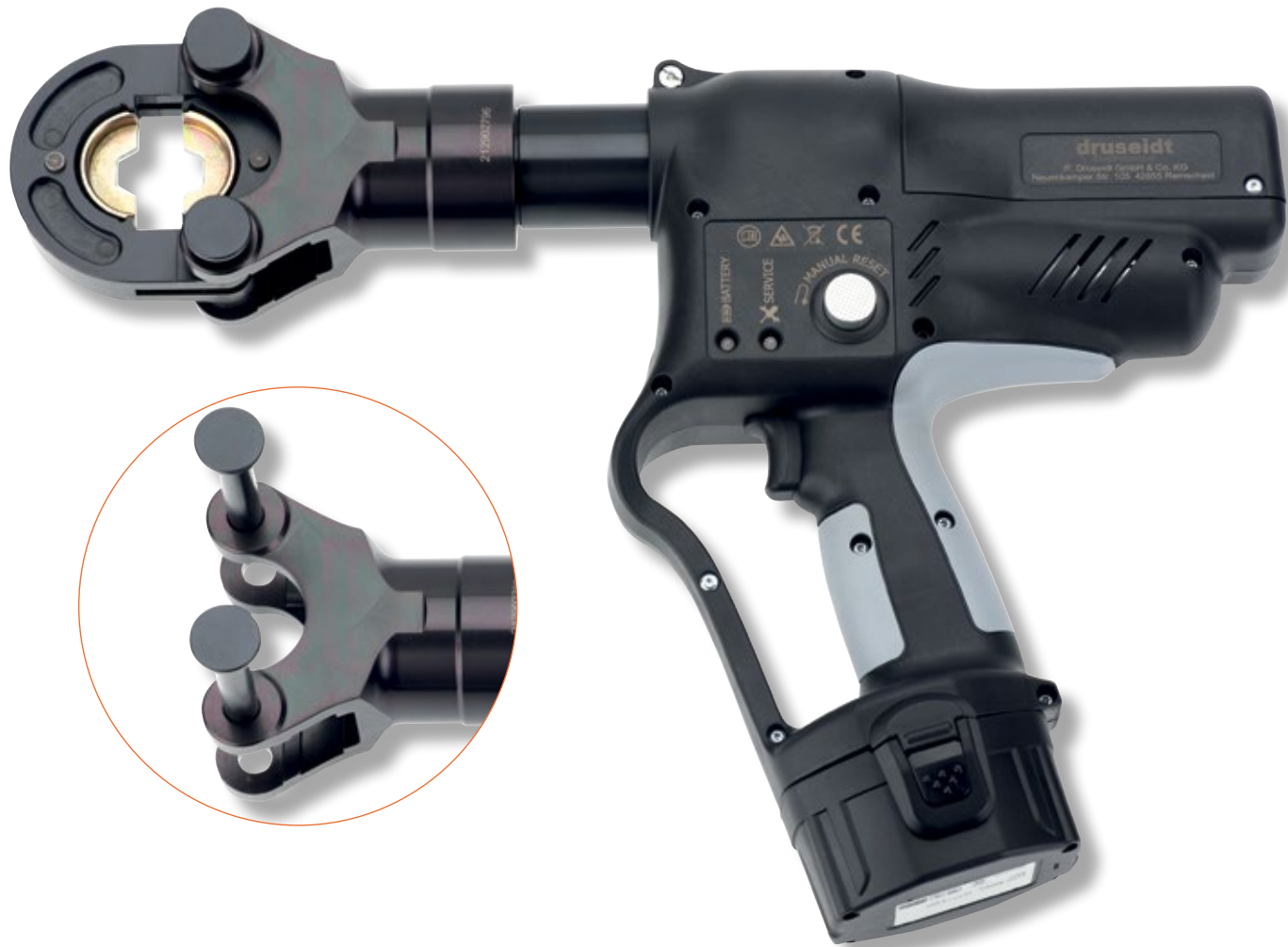

14241



14242



14243



14244

**Crimping**

**Cutting**

**Deliverable exchangeable tool heads**

- universal battery operated hydraulic crimping and cutting tool with exchangeable tool heads
- deliverable tool heads
- **Part-No. 14241** collapsible crimping head for half shell dies
- **Part-No. 14242** collapsible crimping head for flat dies
- **Part-No. 14243** cutting head for copper and aluminium cables max. Ø 65 mm
- **Part-No. 14244** cutting head for ACSR-cables max. Ø 55 mm
- two stage hydraulic system with quick feed and power stroke
- collapsible, 360° rotating tool heads

- automatic pressure limit and monitoring by a pressure sensor
- electronic control and inspection of the crimping cycle
- quick motor stop and manual retraction
- automatic motor stop and automatic retraction once crimp is completed (the automatic retraction function can be switched off in case of need)
- USB-interface for remote diagnosis analysis software with interpretation-, service- and monitoring function
- optical failure- and stand-by indication system
- high performance Lithium-Ion-battery
- 230 V mains adapter as accessory part



## Battery operated hydraulic crimping and cutting tool 60 kN druseidt-system with exchangeable tool heads



die-sets for crimping head Part-No. 14241  
druseidt system dies size II  
half shell dies in small design



die-sets for crimping head Part-No. 14242  
druseidt system dies size I  
flat design

Part-No.	cross-section range	description/scope of supply	
14240	1,5 - 300 mm <sup>2</sup>	1 standard set consisting out of: 1 piece battery operated basic unit 60 kN without tool heads 1 piece Li-Ion-battery 14,4 V, 2,6 Ah	1 piece battery charger 230 V 1 piece analysis software 1 piece USB-connecting lead
14241		crimping head for half shell dies	
14242		crimping head for flat dies	
14243		cutting head for copper- and aluminium-cables up to 65 mm Ø	
14244		cutting head for ACSR-cables up to 45 mm Ø	
14245		steel carrying case	

### Accessories

13553	Replacement Li-Ion-battery 14,4 V, 2,6 Ah
13554	Replacement battery charger 230 V
13555	230 V mains adapter with 5 m connecting lead
13538	Shoulder strap

### Technical data

- crimping force: 60 kN
- max. stroke: 55 mm
- operating pressure: 700 bar
- Li-Ion-battery 14,4 V/2,6 Ah
- crimping time: 3-6 sec. (in dependence of the cross-section)
- time of loading: ca. 45 min.
- battery charger: 230 V/50 Hz with 2 m connecting lead
- weight in dependence of the tool head 6,0-7,5 kg

## Range of application/deliverable crimping dies

Application for crimping heads	Exchangeable tool heads	
	Part-No. 14241	Part-No. 14242
<b>Indent-crimping</b> for cable lugs acc. to DIN 46234 + DIN 46230	10 - 120 mm <sup>2</sup>	10 - 70 mm <sup>2</sup>
<b>Indent-crimping</b> for druseidt stainless steel cable lugs	1,5 - 35 mm <sup>2</sup>	1,5 - 35 mm <sup>2</sup>
<b>WM-crimping</b> for tubular cable lugs and connectors		
• druseidt Standard design	10 - 300 mm <sup>2</sup>	10 - 300 mm <sup>2</sup>
• druseidt Euro-design	10 - 300 mm <sup>2</sup>	10 - 300 mm <sup>2</sup>
<b>WM-crimping</b> for tubular cable lugs and connectors		
• druseidt design for fine stranded cables	10 - 240 mm <sup>2</sup>	10 - 240 mm <sup>2</sup>
<b>Hexagonal crimping</b> for tubular cable lugs and connectors		
• copper acc. to DIN 46235/DIN 46267 part 1	6 - 300 mm <sup>2</sup>	10 - 300 mm <sup>2</sup>
• aluminium acc. to DIN 46329/46267 part 2	10 - 300 mm <sup>2</sup>	16 - 300 mm <sup>2</sup>
<b>Trapezoid crimping</b> for cable end sleeves acc. to DIN 46228 part 1 + 4	10 - 185 mm <sup>2</sup>	25 - 95 mm <sup>2</sup>
<b>Trapezoid crimping</b> for twin cable end sleeves	2 x 4 up to 2 x 16 mm <sup>2</sup>	-
<b>Oval crimping</b> for insulated cable lugs and connectors	-	10 - 35 mm <sup>2</sup>
<b>Crimping dies for C- and H-shaped connectors</b>	on request	-
<b>Application for cutting heads</b>	<b>Part-No. 14243</b>	<b>Part-No. 14244</b>
• Copper/Aluminium-cables	up to 55 mm Ø	-
• ACSR-cables	-	up to 45 mm Ø

Selection charts for crimping dies with Part-No. and description are listed in this catalogue on pages 202-205.

## Battery operated hydraulic crimping and cutting tool 100 kN druseidt-system with exchangeable tool heads



### Exchangeable tool heads

Crimping head



Cutting head



### Deliverable tool heads

- Battery operated tools with exchangeable tool heads offer an economically and mobile crimping of cable lugs and connectors as well as cutting of copper- and aluminium-cables
- Deliverable tool heads
  - **Part-No. 12753** collapsible crimping head for flat dies
  - **Part-No. 12751** cutting head for copper and aluminium cables up to 54 mm Ø
- two stage hydraulic system with quick feed and power stroke
- collapsible, 360° rotating tool head
- automatic pressure limit and monitoring by a pressure sensor

- electronic control and inspection of the crimping cycle
- quick motor stop and manual retraction
- automatic motor stop and automatic retraction once crimp is completed (the automatic retraction function can be switched off in case of need)
- USB-interface for remote diagnosis
- analysis software with interpretation-, service- and monitoring function
- optical failure- and stand-by indication system
- high performance Lithium-Ion battery
- 230 V mains adapter as accessory part

## Battery operated hydraulic crimping and cutting tool 100 kN druseidt-system with exchangeable tool heads



Crimping dies  
**druseidt system dies size I**  
flat design

Part-No.	cross-section range	description/scope of supply	
12748	10 - 300 mm <sup>2</sup>	1 standard set consisting out of: 1 piece battery operated basic unit 100 kN without tool heads 1 piece Li-Ion-battery 14,4 V, 2,6 Ah	1 piece battery charger 230 V 1 piece analysis software 1 piece USB connecting lead
12749		steel carrying case	
12753		crimping head for flat dies	
12751		cutting head for copper- and aluminium cables up to 54 mm Ø	

### Accessories

13553	Replacement Li-Ion-battery 14,4 V, 2,6 Ah
13554	Replacement battery charger 230 V
13555	230 V mains adapter with 5 m connecting lead
13538	Shoulder strap

### Technical data

• crimping force: 100 kN	• Li-Ion-battery 14,4 V/2,6 Ah
• max. stroke: 17 mm	• time of loading: ca. 45 min.
• operating pressure: 700 bar	• battery charger: 230 V/50 Hz with 2 m connecting lead
• crimping time: 3-6 sec. (in dependence of the cross-section)	• weight: with crimping head 5,3 kg with cutting head 6,1 kg

### Application range for crimping head Part-No. 12753

- **Indent-crimping 10-70 mm<sup>2</sup>**  
for cable lugs acc. to DIN 46234 + DIN 46230
- **Indent-crimping 1,5-35 mm<sup>2</sup>**  
for druseidt stainless steel cable lugs
- **WM-crimping 10-300 mm<sup>2</sup>**  
for tubular cable lugs and connectors  
- druseidt Standard design  
- druseidt Euro-type design
- **WM-crimping 10-240 mm<sup>2</sup>**  
for tubular cable lugs and connectors  
- druseidt design for fine stranded cables
- **Hexagonal-crimping 10/16-300 mm<sup>2</sup>**  
for cable lugs and connectors  
- copper DIN 46235/DIN 46267 part 1  
- aluminium DIN 46329/DIN 46267 part 2
- **Round-crimping dies 25/35-185/240 mm<sup>2</sup>**
- **Trapezoid-crimping 25-95 mm<sup>2</sup>**  
for cable end sleeves acc. to DIN 46228 part 1 + 4

### Application range of cutting head Part-No. 12751

For cutting of copper- and aluminium cables up to a outer-Ø of 54 mm

Selection charts for crimping dies with Part-No. and description are listed in this catalogue on pages 202-203.

**Battery operated hydraulic crimping tool 60 kN  
with fixed crimping head**



13555  
230 V mains adapter

- Handy crimping tool for economically and mobile crimping operations
- suitable for working with druseidt system dies size II (half shell dies in small design)
- two stage hydraulic system with quick feed and power stroke
- collapsible, 360° rotating tool heads
- automatic pressure limit and monitoring by a pressure sensor
- electronic control and inspection of the crimping cycle
- quick motor stop and manual retraction
- automatic motor stop and automatic retraction once crimp is completed (the automatic retraction function can be switched off in case of need)
- USB-interface for remote diagnosis
- analysis software with interpretation-, service- and monitoring function
- optical failure- and stand-by indication system
- high performance Lithium-Ion-battery
- 230 V mains adapter as accessory part



## Battery operated hydraulic crimping tools 60 kN with fixed crimping heads



Crimping dies  
**druseidt system dies size II**  
(half shell dies in small design)

Part-No.	cross-section range	description/scope of supply	
13552	1,5 - 300 mm <sup>2</sup>	1 standard set consisting out of:	
		1 piece battery operated basic unit 60 kN without die sets	1 piece analysis software
		1 piece Li-Ion-battery 14,4 V, 2,6 Ah	1 piece USB connecting lead
		1 piece battery charger 230 V	1 piece steel carrying case

### Accessories

13553	Replacement Li-Ion-battery 14,4 V, 2,6 Ah
13554	Replacement battery charger 230 V
13555	230 V mains adapter with 5 m connecting lead
13538	Shoulder strap

### Technical data

- crimping force: 60 kN
- max. stroke: 17 mm
- operating pressure: 700 bar
- crimping time: 3-6 sec.  
(in dependence of the cross-section)
- Li-Ion-battery 14,4 V/2,6 Ah
- time of loading: ca. 45 min.
- battery charger: 230 V/50 Hz with 2 m connecting lead
- weight: ca. 4,15 kg

## Range of application/deliverable crimping dies

- **Indent-crimping 10-120 mm<sup>2</sup>**  
for cable lugs acc. to DIN 46234 + DIN 46230
- **Indent-crimping 1,3-35 mm<sup>2</sup>**  
for druseidt stainless steel cable lugs
- **WM-crimping 10-300 mm<sup>2</sup>**  
for tubular cable lugs and connectors  
- druseidt Standard design  
- druseidt Euro-type design
- **WM-crimping 10-240 mm<sup>2</sup>**  
for tubular cable lugs and connectors  
- druseidt design for fine stranded cables
- **Hexagonal crimping 6-300 mm<sup>2</sup>**  
for cable lugs and connectors  
- copper DIN 46235/DIN 46267 part 1  
- aluminium DIN 46329/46267 part 2
- **Round-crimping dies 25/35-185/240 mm<sup>2</sup>**
- **Trapezoid crimping 10-185 mm<sup>2</sup>**  
for cable end sleeves acc. to DIN 46228 part 1 + 4
- **Trapezoid crimping 2 x 4 mm<sup>2</sup> - 2 x 16 mm<sup>2</sup>**  
for twin cable end sleeves
- **Crimping dies for C- and H-shaped connectors on request**

Selection charts for crimping dies with Part-No. and description are listed in this catalogue on pages 204-205.

## Battery operated hydraulic crimping tools 130 kN with fixed crimping heads



- universal crimping tools for economically and mobile crimping operations
- suitable for working with druseidt system dies size III (half shell dies in large design)
- the large crimping width enables an efficient working with a lower number of crimpings compared with tools with small designed half shell dies
- the C-shaped crimping heads enables a side placing of cables and connectors up to 25 mm or 42 mm outside-Ø. Cables/connectors with a bigger diameter can be crimped and removed with the H-shaped crimping head without problem
- two stage hydraulic system with quick feed and power stroke

- collapsible, 360° rotating tool heads
- automatic pressure limit and monitoring by a pressure sensor
- electronic control and inspection of the crimping cycle
- quick motor stop and manual retraction
- automatic motor stop and automatic retraction once crimp is completed (the automatic retraction function can be switched off in case of need)
- USB-interface for remote diagnosis
- analysis software with interpretation-, service- and monitoring function
- optical failure- and stand-by indication system
- high performance Lithium-Ion-battery
- 230 V mains adapter as accessory part

## Battery operated hydraulic crimping tools 130 kN with fixed crimping heads



Crimping dies  
**druseidt system dies size III**  
(half shell dies in large design)

Part-No.	cross-section range	description/scope of supply
13551/25	10 - 300 mm <sup>2</sup>	1 Standard set consisting out of: 1 piece battery operated C-shaped basic unit 130 kN opening width 25 mm without die sets 1 piece Li-Ion-battery 14,4 V/2,6 Ah 1 piece battery charger 230 V 1 piece analysis software 1 piece USB connecting lead 1 piece steel carrying case
13551/42	10 - 300 mm <sup>2</sup>	1 Standard set consisting out of: 1 piece battery operated C-shaped basic unit 130 kN opening width 42 mm without die sets 1 piece Li-Ion-battery 14,4 V/2,6 Ah 1 piece battery charger 230 V 1 piece analysis software 1 piece USB connecting lead 1 piece steel carrying case
13537	10 – 300 mm <sup>2</sup>	1 Standard set consisting out of: 1 piece battery operated H-shaped basic unit 130 kN without die sets 1 piece Li-Ion-battery 14,4 V/2,6 Ah 1 piece battery charger 230 V 1 piece analysis software 1 piece USB connecting lead 1 piece steel carrying case

### Accessories

13553	Replacement Li-Ion-battery 14,4 V, 2,6 Ah
13554	Replacement battery charger 230 V
13555	230 V mains adapter with 5 m connecting lead
13538	Shoulder strap

### Technical data

- crimping force: 130 kN
- operating pressure: 700 bar
- crimping time: 7,8-13,5 sec.  
(in dependence of the cross-section)
- Li-Ion-battery 14,4 V/2,6 Ah
- time of loading: ca. 45 min.
- battery charger: 230 V/50 Hz with 2 m connecting lead
- weight with C-shaped crimping head: ca. 6,9 kg
- weight with H-shaped crimping head: ca. 6,3 kg

## Range of application/deliverable crimping dies

- **Indent-crimping 10-240 mm<sup>2</sup>**  
for cable lugs acc. to DIN 46234 + 46230
- **Indent-crimping 10-95 mm<sup>2</sup>**  
for druseidt stainless steel cable lugs
- **WM-crimping 10-300 mm<sup>2</sup>**  
for tubular cable lugs and connectors  
- druseidt Standard design  
- druseidt Euro-type design
- **WM-crimping 10-240 mm<sup>2</sup>**  
for tubular cable lugs and connectors  
- druseidt design for fine stranded cables
- **Hexagonal crimping 10-300 mm<sup>2</sup>**  
for cable lugs and connectors  
- copper DIN 46235/DIN 46267 part 1  
- aluminium DIN 46329/46267 part 2
- **Round-crimping dies 25/35 - 240/300 mm<sup>2</sup>**
- **Trapezoid crimping 25-185 mm<sup>2</sup>**  
for cable end sleeves acc. to DIN 46228 part 1 + 4
- **Crimping dies for H-shaped connectors 70-120 mm<sup>2</sup>**

Selection charts for crimping dies with Part-No. and description are listed in this catalogue on pages 206-207.



**Battery operated hydraulic cutting tools 60 kN  
for copper- and aluminium-cables up to 50 mm Ø**



- universal cutting tool
- suitable for cutting copper- and aluminium-cables without core wire
- two stage hydraulic system with quick feed and power stroke
- collapsible, 360° rotating cutting head
- automatic pressure limit and monitoring by a pressure sensor-  
electronic control and inspection of the cutting cycle
- quick motor stop and manual retraction
- automatic motor stop and automatic retraction
- USB-interface for remote diagnosis
- analysis software with interpretation-, service- and monitoring function
- optical failure- and stand-by indication system
- high performance Lithium-Ion-battery
- 230 mains adapter as accessory part

Part-No.	cutting force	max. cutting-Ø	description/scope of supply	
13534	60 kN	50 mm	1 Standard set consisting out of:	
			1 piece cutting tool 60 kN	1 piece analysis software
			1 piece Li-Ion-battery 14,4 V, 2,6 Ah	1 piece USB connecting lead
			1 piece battery charger 230 V	1 piece steel carrying case

**Accessories**

13553	Replacement Li-Ion-battery 14,4 V, 2,6 Ah
13554	Replacement battery charger 230 V
13555	230 V mains adapter with 5 m connecting lead
13538	Shoulder strap

**Technical data**

- crimping force 60 kN
- operating pressure 700 bar
- weight 5,6 kg
- Li-Ion-battery 14,4 V/2,6 Ah
- time of loading ca. 45 min.
- battery charger 230 V/50 Hz with 2 m connecting lead

The cutting tools are not applicable for cutting steel-wires, cables with steel inserts or solid conductors. They are also not applicable for all kind of live line working.



## Battery operated hydraulic cutting tool 70 kN for copper- and aluminium-cables up to 85 mm Ø



- universal cutting tool
- suitable for cutting copper- and aluminium-cables without core wire
- two stage hydraulic system with quick feed and power stroke
- collapsible, 360° rotating cutting head
- automatic pressure limit and monitoring by a pressure sensor
- electronic control and inspection of the cutting cycle
- quick motor stop and manual retraction
- automatic motor stop and automatic retraction
- USB-interface for remote diagnosis
- analysis software with interpretation-, service- and monitoring function
- optical failure- and stand-by indication system
- high performance Lithium-Ion-battery
- 230 mains adapter as accessory part

Part-No.	cutting force	max. cutting-Ø	description/scope of supply	
13535	70 kN	85 mm	1 Standard set consisting out of:	
			1 piece cutting tool 70 kN	1 piece analysis software
			1 piece Li-Ion-battery 14,4 V, 2,6 Ah	1 piece USB-connecting lead
			1 piece battery charger 230 V	1 piece steel carrying case

### Accessories

13553	Replacement Li-Ion-battery 14,4 V, 2,6 Ah
13554	Replacement battery charger 230 V
13555	230 V mains adapter with 5 m connecting lead
13538	Shoulder strap

### Technical data

- crimping force 70 kN
- operating pressure 700 bar
- weight 7,3 kg
- Li-Ion-battery 14,4 V/2,6 Ah
- time of loading ca. 45 min.
- battery charger 230 V/50 Hz with 2 m connecting lead

The cutting tools are not applicable for cutting steel-wires, cables with steel inserts or solid conductors. They are also not applicable for all kind of live line working.

## Battery operated hydraulic crimping tool 35 kN "druseidt Mini"

Crimping dies  
for "druseidt Mini"

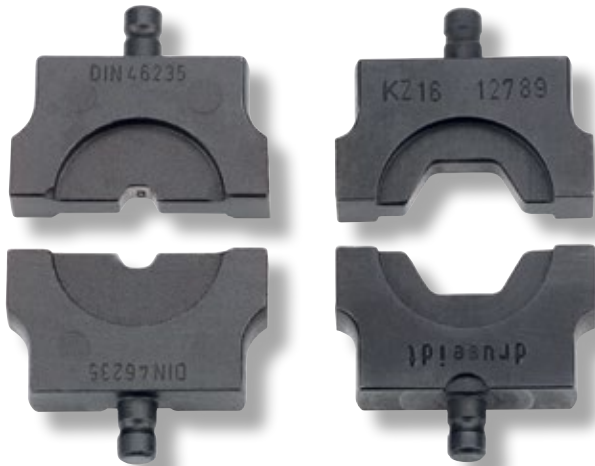

- extremely handy crimping tool with small, collapsible crimping head
- the light weight and the cylindrical shaped design offer a working in cramped conditions too
- two stage hydraulic system with quick feed and power stroke
- well suited for working in a cross-section range up to 120 mm<sup>2</sup> and users who do not need so much electronic performances
- simply and uncomplicated handling
- with 360° rotating crimping head
- quick motor stop and manual retraction
- for application > 120 mm<sup>2</sup> we recommend our bigger cylindrical battery operated hydraulic crimping tool "druseidt-standard" deliverable with the whole electronic performances and analysis software according to the catalogue page 186

Part-No.	cross-section range	description/scope of supply
12725	10 - 120 mm <sup>2</sup>	1 Standard set consisting out of: 1 piece crimping tool 35 kN without die sets 1 piece Li-Ion-battery 18 V, 1,5 Ah 1 piece battery charger 230 V 1 piece steel carrying case

### Accessories

12726	Replacement Li-Ion-battery 18 V, 1,5 Ah
12727	Replacement battery charger 230 V

### Technical data

- crimping force: 35 kN
- operating pressure: 700 bar
- Li-Ion-battery 18 V/1,5 Ah
- battery charger: 230 V, 50 Hz with 2 m connecting lead I
- crimping time: 3-6 sec. (in dependence of the cross-section)
- weight: 2,1 kg
- length: 360 mm

## Range of application/deliverable crimping dies

- **Indent-crimping 10-35 mm<sup>2</sup>**  
for cable lugs acc. to DIN 46234 + 46230
- **WM-crimping 10-120 mm<sup>2</sup>**  
for tubular cable lugs and connectors  
- druseidt Standard design  
- druseidt Euro-type design
- **WM-crimping 10-95 mm<sup>2</sup>**  
for tubular cable lugs and connectors  
- druseidt design for fine stranded cables
- **Hexagonal crimping 10/16-95 mm<sup>2</sup>**  
for cable lugs and connectors  
- copper DIN 46235/DIN 46267 part 1  
- aluminium DIN 46329/46267 part 2

## Exchangeable die sets for crimping tool "druseidt-Mini"

### Indent-crimping 10-35 mm<sup>2</sup>

for cable lugs acc. to DIN 46234 + DIN 46230

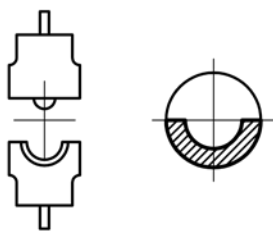

Part-No.	cross-section mm <sup>2</sup>
12548	10
12549	16
12550	25
12551	35

### WM-crimping 10-120 mm<sup>2</sup>

for tubular cable lugs and connectors  
druseidt Standard design

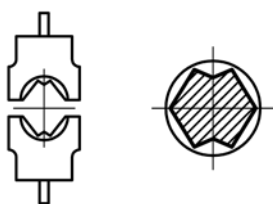

Part-No.	cross-section mm <sup>2</sup>	crimping width mm
12792	10	5
12793	16	5
12794	25	5
12795	35	5
12796	50	5
12797	70	5
12798	95	5
12799	120	5

### WM-crimping 10-120 mm<sup>2</sup>

for tubular cable lugs and connectors  
druseidt Euro-type design

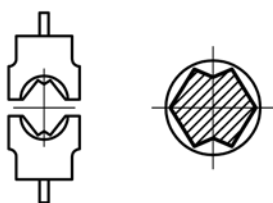

Part-No.	cross-section mm <sup>2</sup>	crimping width mm
12554	10	5
12555	16	5
12556	25	5
12557	35	5
12558	50	5
12559	70	5
12560	95	5
12561	120	5

### WM-crimping 10-95 mm<sup>2</sup>

for tubular cable lugs and connectors  
druseidt design for fine stranded cables

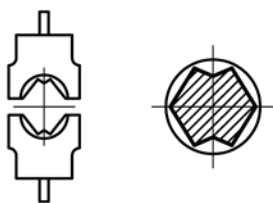

Part-No.	cross-section mm <sup>2</sup>	crimping width mm
12740	10	5
12741	16	5
12742	25	5
12743	35	5
12744	50	5
12745	70	5
12746	95	5

### Hexagonal crimping 10-95 mm<sup>2</sup>

for cable lugs and connectors  
copper DIN 46235/DIN 46267 part 1  
aluminium DIN 46329/DIN 46267 part 2

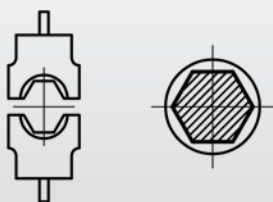

Part-No.	code-no.	cross-section mm <sup>2</sup>		crimping width mm
		Cu	Al	
12784	6	10	-	5
12785	8	16	-	5
12786	10	25	-	5
12787	12	35	16/25	5
12788	14	50	35	5
12789	16	70	50	5
12790	18	95	70	5

**Battery operated hydraulic crimping tool 50 kN, “druseidt Standard“ in bar-shaped design with exchangeable crimping dies 1,5 up to 240 mm<sup>2</sup>**



crimping dies  
**druseidt system dies size I**  
(flat dies)

- handy crimping tool in bar-shaped design offers a wide range of crimping performances
- equipped with the same electronic functions like the battery operated tools in pistol design
- well suited for a fatigue-free working also when crimping bigger cross-sections
- two stage hydraulic-system with quick feed and power stroke
- collapsible 360° rotating crimping head
- automatic pressure limit and monitoring by a pressure sensor
- quick motor stop and manual retraction option
- automatic motor stop and automatic retraction once crimp is completed (the automatic retraction function can be switched off in case of need)
- USB-interface for remote diagnosis
- analysis software with interpretation-, service- and monitoring function
- optical failure- and stand-by indication system



## Battery operated hydraulic crimping tool 50 kN "druseidt Standard" in bar-shaped design with exchangeable crimping dies 1,5 up to 240 mm<sup>2</sup>



Part-No.	cross-section range	description/scope of supply
12728	1,5 - 240 mm <sup>2</sup>	1 standard set consisting out of: 1 piece crimping tool 50 kN without die sets 1 piece Li-Ion-battery 18 V/1,5 Ah 1 piece battery charger 230 V 1 piece analysis software 1 piece USB connecting lead 1 piece steel carrying case

### Accessories

12726	Replacement Li-Ion-battery 18 V/1,5 Ah
12727	Replacement battery charger 230 V

### Technical data

• crimping force 50 kN	• battery charger 230 V with 2 m connecting lead
• operating pressure 700 bar	• crimping time 3-6 sec.(in dependence of the cross-section)
• Li-Ion-battery 18 V/1,5 Ah	• weight 2,8 kg
• time of loading ca. 45 minutes	• length 400 mm

### Range of application/deliverable crimping dies

- **Indent-crimping 10-70 mm<sup>2</sup>**  
for cable lugs acc. to DIN 46234 + DIN 46230
- **Indent-crimping 1,5-35 mm<sup>2</sup>**  
for druseidt stainless steel cable lugs
- **WM-crimping 10-240 mm<sup>2</sup>**  
for tubular cable lugs and connectors  
- druseidt Standardseries  
- druseidt Euroseries
- **WM-crimping 10-185 mm<sup>2</sup>**  
for tubular cable lugs an connectors  
- druseidt design for fine stranded cables
- **Hexagonal-crimping 10/16-185 mm<sup>2</sup>**  
for cable lugs and connectors  
- copper DIN 46235/DIN 46267 part 1  
- aluminium DIN 46329/DIN 46267 part 2
- **Round-crimping dies 25/35-185/240 mm<sup>2</sup>**
- **Trapezoid crimping 10-95 mm<sup>2</sup>**  
for cable end sleeves acc. to DIN 46228  
part 1 + 4

Selection charts for crimping dies with Part-No. and description are listed in this catalogue on pages 202-203.

**Battery operated hydraulic crimping tool 60 kN in bar-shaped design  
with foldable crimping head and exchangeable crimping dies 1,5 up to 300 mm<sup>2</sup>**



Crimping dies  
**druseidt-System dies size II**  
(half shell dies in small design)

- handy crimping tool in bar-shaped design offers a wide range of crimping performances
- equipped with the same electronic functions like the battery operated tools in pistol design
- well suited for a fatigue-free working also when crimping bigger cross-sections
- two stage hydraulic-system with quick feed and power stroke
- collapsible 360° rotating crimping head
- automatic pressure limit and monitoring by a pressure sensor
- quick motor stop and manual retraction option
- automatic motor stop and automatic retraction once crimp is completed (the automatic retraction function can be switched off in case of need)
- USB-interface for remote diagnosis
- analysis software with interpretation-, service- and monitoring function
- optical failure- and stand-by indication system

## Battery operated hydraulic crimping tool 60 kN in bar-shaped design with foldable crimping head and exchangeable crimping dies 1,5 up to 300 mm<sup>2</sup>



Part-No.	cross-section range	description/scope of supply
12724	1,5 - 300 mm <sup>2</sup>	1 standard set consisting out of: 1 piece crimping tool 60 kN without die sets 1 piece Li-Ion-battery 18 V/1,5 Ah 1 piece battery charger 230 V 1 piece analysis software 1 piece USB connecting lead 1 piece steel carrying case

### Accessories

12726	Replacement Li-Ion-battery 18 V/1,5 Ah
12727	Replacement battery charger 230 V

### Technical data

<ul style="list-style-type: none"> <li>• crimping force 60 kN</li> <li>• operating pressure 700 bar</li> <li>• Li-Ion-battery 18 V/1,5 Ah</li> <li>• time of loading ca. 45 minutes</li> </ul>	<ul style="list-style-type: none"> <li>• battery charger 230 V with 2 m connecting lead</li> <li>• crimping time 3-6 sec.(in dependence of the cross-section)</li> <li>• weight 2,8 kg</li> <li>• length 400 mm</li> </ul>
--	--

### Range of application/deliverable crimping dies

- **Indent-crimping 10-120 mm<sup>2</sup>**  
for cable lugs acc. to DIN 46234 + DIN 46230
- **Indent-crimping 1,5-35 mm<sup>2</sup>**  
for druseidt stainless steel cable lugs
- **WM-crimping 10-300 mm<sup>2</sup>**  
for tubular cable lugs and connectors  
- druseidt Standardseries  
- druseidt Euroseries
- **WM-crimping 10-240 mm<sup>2</sup>**  
for tubular cable lugs an connectors  
- druseidt design for fine stranded cables
- **Hexagonal-crimping 6-300 mm<sup>2</sup>**  
for cable lugs and connectors  
- copper DIN 46235/DIN 46267 part 1  
- aluminium DIN 46329/DIN 46267 part 2
- **Round-crimping dies 25/35-185/240 mm<sup>2</sup>**
- **Trapezoid crimping 10-240 mm<sup>2</sup>**  
for cable end sleeves acc. to DIN 46228  
part 1 + 4
- **Trapazoid crimping 2 x 4 mm<sup>2</sup> - 2 x 16 mm<sup>2</sup>**  
for Twin cable end sleeves
- **Crimping dies for C- and H-shaped connectors on request**

Selection charts for crimping dies with Part-No. and description are listed in this catalogue on pages 204-205.

**Battery operated hydraulic cutting tool 30 kN  
for stranded copper- and aluminium cables up to 40 mm Ø**



- Handy cutting tool with open cutting head and endless rotation
- Suitable for cutting stranded copper- and aluminium cables without core wire
- Ideal for mobile use
- Automatic pressure limit and monitoring by a pressure sensor
- Automatic cutting detection with motor cut-off and automatic return after completed cutting process
- Quick motor stop and manual return option
- Electronic control and inspection of the cutting cycle
- USB interface for connection to all common computer systems
- Analysis software with interpretation-, service- and monitoring function
- Optimal failure- and stand-by indication system
- Charge status display directly on the battery



Part-No.	cutting-force	max. cutting-Ø	Discription/scope of supply
12721	30 kN	40 mm	1 Standard-Set consisting out of: 1 piece cutting tool 1 piece Li-Ion battery 18 V, 1,5 Ah 1 piece battery charger 230 V 1 piece analysis software 1 piece USB-connecting cable 1 piece steel carrying case

**Accessories**

12726	Replacement Li-Ion battery 18 V, 1,5 Ah
12727	Replacement battery charger 230 V/50 Hz

**Technical data**

- cutting force 30 kN
- operating pressure: 700 bar
- weight: 2,8 kg
- Li-Ion battery 18 V, 1,5 Ah
- time of loading: ca. 45 minutes
- batery charger: 230 V with 2 m connecting cable
- cutting ranges  
copper 1 x 240 mm<sup>2</sup> or 4 x 50 mm<sup>2</sup>  
aluminium 1 x 500 mm<sup>2</sup> or 4 x 70 mm<sup>2</sup>

The cutting tools are not applicable for cutting steel-wires, cables with steel inserts or solid conductors and for for all kind of life working.



## Hydraulic working systems with exchangeable compression- and cutting heads

When working continuously with bigger cross-sections or equipping fixed workplaces druseidt offers an extensive program of hydraulic working systems consisting out of hydraulic pumps and different crimping and cutting units. To offer a mobile working too also new designed light and handy battery operated hydraulic pumps are besides the traditional pumps part of the delivery program. So all users get the opportunity to order for his crimping and cutting procedures an individual hardware configuration, exactly coordinated with his application. To complement the workplaces with the right stripping technology (described on catalogue pages 141 ff) corresponding different stripping devices are offered too. So all users get the possibility to order mobile as well as stationary systems and are able to equip their workplaces with the right and best practical devices. A detailed consultation about stripping, cutting and crimping solutions as well as a support in the range of quality management are the basis for realizing reproducible electrical cable connections. So our employees will be glad to provide consultation to support your plans.

### druseidt hydraulic working systems

- foot operated pumps
- different sizes of electrohydraulic pumps
- battery operated electrohydraulic pumps
- hydro-pneumatically actuated pumps

### druseidt exchangeable crimping units

- system 60 kN
  - system 130 kN
  - system 250 kN
  - system 450 kN
- for a cross-section range up to 1000 mm<sup>2</sup>

### druseidt exchangeable cutting units

- system 60 kN
  - system 70 kN
  - system 130 kN
- for copper- and aluminium-cables up to a outer-Ø of 95 mm  
resp. ACSR-cables up to outer-Ø of 45 mm



**Hydraulic pumps and accessories**

suitable for working with our crimping- and cutting heads  
with an operating pressure of 700 bar



Part-No.	operating pressure	description/scope of supply
12480	700 bar	Hydraulic foot pump with 2 m high pressure hose and quick coupling without tool heads
<b>Technical data</b>		
<ul style="list-style-type: none"> <li>operating pressure: 700 bar</li> <li>oil filling: 1 liter</li> <li>operating temperature: -20° C up to +40° C</li> </ul>		<ul style="list-style-type: none"> <li>dimensions: 170 mm x 190 mm x 660 mm</li> <li>weight: 9 kg</li> </ul>
<b>Remark:</b> Two stage hydraulic foot pump with safety valve, automatic changeover switching and as needed manuell return travel also when working in the high pressure range.		



Part-No.	operating pressure	description/scope of supply
05254	700 bar	Electro-hydraulic pump with 1,8 m high pressure hose, hand switch and quick coupling without tool heads
05253		Double foot pedal for elcetro-hydraulic pump 05254
<b>Technical data</b>		
<ul style="list-style-type: none"> <li>operating pressure: 700 bar</li> <li>operating voltage: 230 V/50 Hz</li> <li>nominal capacity: 0,4 kW</li> <li>delivery rate: 0-20 bar 2 l/min</li> </ul>		<ul style="list-style-type: none"> <li>delivery rate: 20-700 bar 1,2 l/min</li> <li>useable oil volume: 0,8 liter, oil filling 1,2 liter</li> <li>dimensions: 300 mm x 150 mm x 285 mm</li> <li>weight: 8 kg</li> </ul>
<b>Remark:</b> handy two stage electro-hydraulic pump with pressure limiting valve and automatic changeover switching. Caused by the light weight and the small dimensions also well suited for mobile working.		

## Electro-hydraulic pumps with accessories

suitable for working with our crimping- and cutting heads with an operating pressure of 700 bar



Part-No.	operating pressure	tank volume	description
05270	700 bar	2 Liter	Electro-hydraulic pump without tool heads and high pressure hose
05272	700 bar	5 Liter	Electro-hydraulic pump without tool heads and high pressure hose
05274			Hand switch
05275			Foot switch

### technical data

- operating pressure: 700 bar
- operating voltage: 230 V/50 Hz
- 4-cylinder pump with quick feed
- high pressure delivery rate: 0,34 l/min
- low pressure delivery rate: 0,80 l/min
- Aluminum-box with steel tank
- Motor rating: 370 W (4-phase motor)

#### Part-No. 05270

- Tank volume: 2 liter
- useable oil volume: 1,8 liter
- dimensions: 380/430 mm x 210 mm x 395 mm
- weight 15 kg

#### Part-No. 05272

- Tank volume: 5 liter
- useable oil volume: 4 liter
- dimensions: 385/435 mm x 245 mm x 420 mm
- weight: 20 kg

**Remark:** Two stage electro-hydraulic pumps with pressure limiting valve and automatic changeover switching. All pumps can be actuated by a hand switch/remote control or alternatively by a food pedal with automatic safety device. Therefore when ordering a pump please be so kind and order the needed switch separately. The pumps will be actuated by pressing the switch and then the pumps open automatically when the operating pressure is achieved. At any time, in the high pressure as well as in the low pressure range, it is possible to break the operation and to open the pump immediately.

## High pressure hoses with quick coupling

suitable for connecting our crimping- and cutting heads with an operating pressure of 700 bar



Part-No.	description
05258	with steel mesh inlay, non-insulating, 2 m length
05259	with steel mesh inlay, non-insulating, 3 m length
05260	with steel mesh inlay, non-insulating, 4 m length
05262	with steel mesh inlay, non-insulating, 5 m length



## Battery operated electro-hydraulic pump

suitable for working with our crimping- and cutting heads  
with an operating pressure of 700 bar



Standard set including accessories

- Light, compact and robust construction with fiber-glass reinforced, non conducting and shock proof, body out of Polyamide. Therefore well suited for mobile application.
- The system has extremely rapid advancement thanks to a special double piston-technology, characterized by a low-pressure- and a slow high-pressure advancement.
- Quick tool return by high return conveyor volumetric guarantees quick working cycles.
- Equipped with a capacity recognition system that permits precise work with or without the hydraulic hose (the machine may be connected directly to the pump).
- The motor is adjusted with PWM (soft start to save the transmission, motor and battery).
- The return stroke of the tool head is controlled by a software.
- Control of the equipment is realized through a micro-controller.
- Pressure control is performed by an electronic pressure sensor.
- The charge of the power pack is kept constantly under control.
- The traceability of work cycles is ensured through automatic registration and saving in the machine memory. Management of technical assistance is performed with an electronic system and the included analysis software.
- The data saved can be read and the software can be updated through a mini USB interface.
- Actuation through the hand switch/remote control.
- Additionally LED indicators provide rapid information on the status of the machine.
- Retraction optionally automatically or manually with retraction stop function.

Part-No.	operating pressure	description/scope of supply	
05265	700 bar	1 Standard set consisting out of:	
		- 1 piece battery operated pump without tool heads	- 1 piece high pressure hose 1,5 m
		- 1 piece Li-Ion-battery 18 V, 3,0 Ah	- 1 piece shoulder strap
		- 1 piece battery charger 230 V, 50 Hz	- 1 piece carry bag with additional pockets
		- 1 piece analysis software	
		- 1 piece USB connecting lead	
<b>Accessories</b>			
12726/3,0		Replacement Li-Ion-battery 18 V, 3,0 Ah	
12727		Replacement battery charger 230 V for Li-Ion-battery 18 V	
12729		230 V mains adapter 18 V with 5 m connecting lead	
05267		high pressure hose with quick coupling 1,5 m length	
05268		high pressure hose with quick coupling 1,5 m length	
05269		high pressure hose with quick coupling 10 m length	

### Technical data

- operating pressure: 700 bar (70 MPa)
- delivery rate: 1,15 l/min (low-pressure range)  
0,15 l/min (high pressure range)
- automatic conversation from low to high pressure takes place at approximately 90 bar
- with DC-motor
- Li-Ion-battery 18 V DC, 3,0 Ah
- battery charger: 230 V, 50 Hz with 2 m connecting lead
- time of loading: ca. 45-50 min.
- operating temperature: -20° C up to +55° C
- protection class: IP 43
- dimensions: 300 mm x 195 mm x 210 mm
- weight: ca. 4,7 kg



### Battery operated electro-hydraulic pump

with additional integrated display and additional functions suitable for working with our crimping- and cutting heads with an operating pressure of 700 bar



Standard set including accessories

**Design according to the description of battery operated pump Part-No. 05265 page 190 but with additional integrated display and following additional functions:**

- The progress of compression can be shown on the display (pressure and operating time)
- Pressure control indication
- Error message (crimping error, temperature, battery self-diagnosis)
- Indication of service and machine data
- In drive (knob) input and output element
- Possibility for working with preinstalled standard programs for crimping or cutting with:
  - Automatic or manual return flow
  - Hold time setting
  - Instep function by means of an automatic adjustment
  - Return stop function
  - Immediate cutting opening after cut and letting go the button (automatic cutting detection)
- Storable operator program

Part-No.	operating pressure	description/scope of supply	
05266	700 bar	1 Standard set consisting out of:	
		- 1 piece battery operated pump without tool heads	- 1 piece high pressure hose 1,5 m length
		- 1 piece Li-Ion-battery 18 V, 3,0 Ah	- 1 piece shoulder strap
		- 1 piece battery charger 230 V, 50 Hz	- 1 piece carry bag with additional pockets
		- 1 piece analysis software	
		- 1 piece USB connecting lead	

#### Accessories

12726/3,0	Replacement Li-Ion-battery 18 V, 3,0 Ah
12727	Replacement battery charger 230 V for Li-Ion-battery 18 V
12729	230 V mains adapter 18 V with 5 m connecting lead
05267	high pressure hose with quick coupling 1,5 m length
05268	high pressure hose with quick coupling 5 m length
05269	high pressure hose with quick coupling 10 m length

#### Technical data

- operating pressure: 700 bar (70 MPa)
- delivery rate: 1,15 l/min (low-pressure range)  
0,15 l/min (high pressure range)
- automatic conversation from low to high pressure takes place at approximately 90 bar
- with DC-motor
- Li-Ion-battery 18 V DC, 3,0 Ah
- battery charger: 230 V, 50 Hz with 2 m connecting lead
- time of loading: ca. 45-50 min.
- operating temperature: -20° C up to +55° C
- protection class: IP 43
- dimensions: 300 mm x 195 mm x 210 mm
- weight: ca. 4,7 kg

### Hydro-pneumatically actuated pumps

suitable for working with our crimping- and cutting heads with an operating pressure of 700 bar

- Ergonomically designed high performance pumps
- Well suited for working with our crimping- and cutting heads with 700 bar operating pressure
- Stable and compact design with relatively low weight
- The incoming air pressure is converted into a high hydraulic operating pressure via a pressure intensifier
- The pumps are operated by a foot pedal so that both hands are free for other activities
- Inexpensive and universally applicable



Part-No.	operating pressure	tank volume	description
05276	700 bar	2,4 l	Hydro-pneumatically actuated foot pumps with 2 m long high pressure
05286	700 bar	5,0 l	hose and quick coupling
05277			High pressure hose 3 m long one side AG 3/8" NPT - other side Cejn quick coupling
05278			High pressure hose 4 m long one side AG 3/8" NPT - other side Cejn quick coupling
05279			High pressure hose 6 m long one side AG 3/8" NPT - other side Cejn quick coupling
05280			High pressure hose 10 m long one side AG 3/8" NPT - other side Cejn quick coupling

#### Technical data

- Required air pressure: max. 6 bar
- Operating pressure: max. 700 bar
- Tank volume: 2,4 l / 5,0 l
- Oil flow rate: up to 2,7 l/min
- Dimensions:  
05276: 365 x 155 x 109 mm, 05286: 365 x 178 x 137 mm
- Weight:  
05276: 6,3 kg, 05286: 10,2 kg
- Low noise: ca. 75 dbA
- Air consumption: 400 NI/Min.

**Remark:** All high pressure hoses have a port on the pump side AG 3/8" NPT as well as a Cejn quick coupling for connecting our crimping- and cutting heads at the other side. On request the pump is also available with larger oil tanks as 5,0 l.

## Hydraulic compression heads 60 kN up to 450 kN

suitable for connection to our 700 bar basic pumps



**Part-No. 12836**  
60 kN / 6-300 mm<sup>2</sup>  
with foldable crimping head



**Part-No. 12485**  
130 kN / 10-300 mm<sup>2</sup>  
lateral insertion up to 25 mm Ø



**Part-No. 12486**  
130 kN / 10-300 mm<sup>2</sup>  
lateral insertion up to 38 mm Ø



**Part-No. 12487**  
130 kN / 10-300 mm<sup>2</sup>



**Part-No. 05256**  
250 kN / 10-630 mm<sup>2</sup>



**Part-No. 12491**  
450 kN / 95-1000 mm<sup>2</sup>

## Crimping dies for hydraulic actuated crimping heads 60 kN up to 450 kN

**Part-No. 12836:** System dies size II (half shell dies small design)  
acc. to catalogue pages 204-205

**Part-No. 05256:** Crimping dies acc. to catalogue pages 208-209

**Part-No. 12485-87:** System dies size III (half shell dies large design)  
acc. to catalogue pages 206-207

**Part-No. 12491:** Crimping dies acc. to catalogue page 209

**Hydraulic compression unit 130 kN**

suitable for mounting on tables and connecting to our 700 bar basic pumps



- Universally applicable compact table top unit
- Suitable for working with a variety of different crimping dies, resulting in an extensive range of applications
- Lateral insertion and removal of cables and connectors up to 25 mm Ø
- Suitable for working with druseidt crimping dies size III (half shell dies, large design)
- The use of these system dies reduces the necessary number of crimp operations caused by the large crimping width
- With quick coupling connection for easy connection to our basic pumps

Part-No.	cross-section range	crimping force	description	weight kg/pcs.
12837	10-300 mm <sup>2</sup>	130 kN	Small C-shaped table crimping unit	12,00

**Remark:** Suitable for working with druseidt crimping dies size III (half shell dies, large design). See pages no. 200-201. Lateral insertion up to Ø 25 mm Ø. With quick coupling connection.

**Range of application/deliverable crimping dies**

- **Indent-crimping 10-240 mm<sup>2</sup>**  
for cable lugs acc. to DIN 46234 + DIN 46230
- **Indent-crimping 10-95 mm<sup>2</sup>**  
for druseidt stainless steel cable lugs
- **WM-crimping 10-300 mm<sup>2</sup>**  
for tubular cable lugs and connectors  
- druseidt Standardseries  
- druseidt Euroseries
- **WM-crimping 10-240 mm<sup>2</sup>**  
for tubular cable lugs and connectors  
- druseidt design for fine stranded cables
- **Hexagonal-crimping 10-300 mm<sup>2</sup>**  
for cable lugs and connectors  
- copper DIN 46235/DIN 46267 part 1  
- aluminium DIN 46329/DIN 46267 part 2
- **Round-crimping dies 25/35-240/300 mm<sup>2</sup>**
- **Trapezoid crimping 25-185 mm<sup>2</sup>**  
for cable end sleeves acc. to DIN 46228 part 1 + 4
- **Crimping dies for C- and H-shaped connectors 70-120 mm<sup>2</sup> on request**

Selection charts for crimping dies with Part-No. and description are listed in this catalogue on pages 206-207.



**Hydraulic cable cutting heads**

for copper- and aluminium- resp. ACSR cables  
suitable for connection to our 700 bar basic-pumps



12832



12833

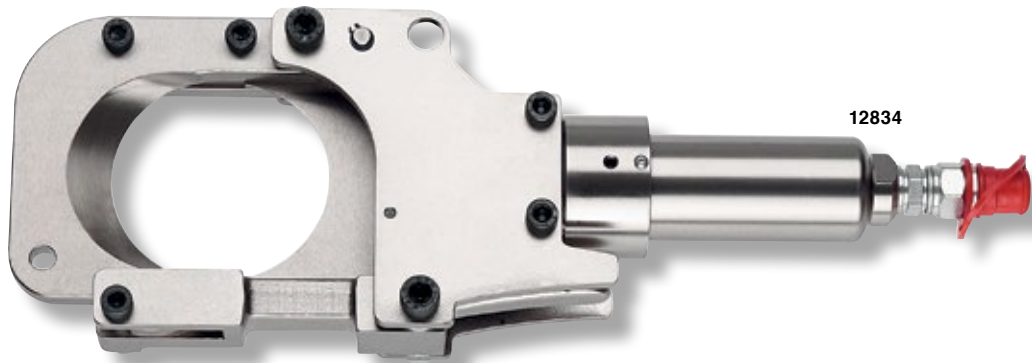

12834



12835

Part-No.	max. cutting-Ø	cutting force	suitable for	length	weight kg/pcs.
12832	45 mm	60 kN	ACSR-Kabel	320 mm	3,5
12833	50 mm	60 kN	Cu-/Al-Kabel	320 mm	2,7
12834	85 mm	70 kN	Cu-/Al-Kabel	420 mm	5,2
12835	95 mm	130 kN	Cu-/Al-Kabel	420 mm	9,8

**Remark:** All cutting heads will be delivered with quick couplings. Part-No. 12832 is suitable for cutting ACSR-cables up to an outer-Ø of 45 mm. All other cutting heads are designed for cutting copper- and aluminium cables in the described diameter range. They are not applicable for cutting steel wires, cables with steel-inserts or solid conductors. They are also not applicable for all kinds of live line working.

**System dies size I (flat design)**

suitable for hand operated hydraulic compression tools Part-No. 12930/12933 acc. to catalogue page 171 as well as battery operated hydraulic compression tools Part-No. 14240/42 acc. to page 176, 12748 acc. to page 178 and Part-No. 12728 acc. to page 188.

**Indent-crimping 10-70 mm<sup>2</sup>**

for cable lugs acc. to DIN 46234 + 46230

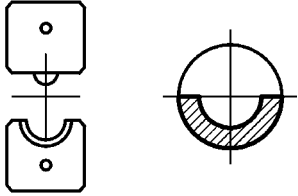

Part-No.	cross-section mm <sup>2</sup>	information
12150	10	Suitable tools for all cross-section ranges 12930/12933, 14240/42, 12748 and 12728.
12151	16	
12152	25	
12153	35	
12154	50	
12155	70	

**Indent-crimping 1,5-35 mm<sup>2</sup>**

for druseidt stainless steel cable lugs

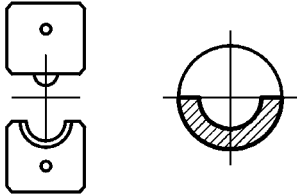

Part-No.	cross-section mm <sup>2</sup>	information
12503	1,5 - 2,5	All crimping dies can be installed in our tools 12930/12933, 14240/42, 12748 and 12728. Up to a cross-section range of 35 mm <sup>2</sup> it is necessary to work for copper and stainless steel cables with different crimping dies.
12504	4-6	
12505	10	
12506	16	
12507	25	
12508/VA	35	
12508/CU	35	

**WM-crimping 10-300 mm<sup>2</sup>**

for tubular cable lugs and connectors druseidt standard design, crimping width 5 mm

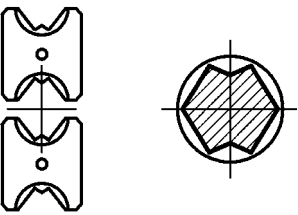

Part-No.	cross-section mm <sup>2</sup>	information
12923	10 + 120	Suitable tools for cross-section up to 240 mm <sup>2</sup> 12930/12933 and 12728 and for cross-section up to 300 mm <sup>2</sup> 14240/42 and 12748.
12924	16 + 70	
12925	25 + 95	
12926	35 + 50	
12927	150	
12928	185	
12929	240	
12929/300	300	

**WM-crimping 10-300 mm<sup>2</sup>**

for tubular cable lugs and connectors druseidt Euro-type design, crimping width 5 mm

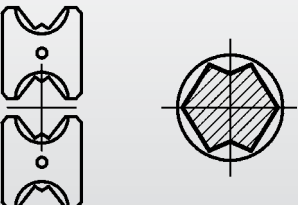

Part-No.	cross-section mm <sup>2</sup>	information
12400	10 + 120	Suitable tools for cross-section up to 240 mm <sup>2</sup> 12930/12933 and 12728 and for cross-section up to 300 mm <sup>2</sup> 14240/42 and 12748
12401	16 + 70	
12402	25 + 95	
12403	35 + 50	
12927	150	
12928	185	
12929	240	
12929/300	300	

## System dies size I (flat design)

### WM-crimping 10f-240f mm<sup>2</sup>

for tubular cable lugs and connectors  
druseidt design for fine stranded cables, crimping width 5 mm

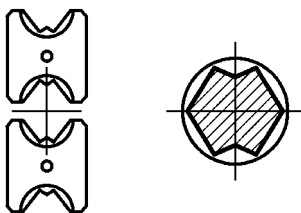

Part-No.	cross-section mm <sup>2</sup>	information
12492	10f + 25f	Suitable tools for cross-section up to 185f mm <sup>2</sup> 12930/12933 and 12728 and for cross-section up to 240f mm <sup>2</sup> 14240/42 and 12748
12493	16f + 35f	
12494	50f	
12495	70f	
12496	95f	
12497	120f	
12498	150f	
12499	185f	
12499/240f	240f	

### Hexagonal-crimping 10-300 mm<sup>2</sup>

for copper cable lugs and connectors  
acc. to DIN 46235/46267 part 1, crimping width 5 mm

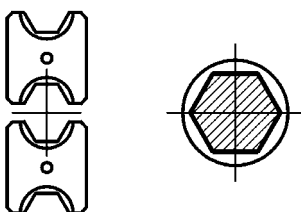

Part-No.	cross-section mm <sup>2</sup>	code-no.	information
12945	10 + 120	6 + 20	Suitable tools for cross-section up to 185 mm <sup>2</sup> 12930/12933 and 12728 and for cross-section up to 300 mm <sup>2</sup> 14240/42 and 12748
12946	16 + 70	8 + 16	
12947	25 + 95	10 + 18	
12948	35 + 50	12 + 14	
12949	150	22	
12950	185	25	
12951	240	28	
12952	300	32	

### Hexagonal-crimping 16-300 mm<sup>2</sup>

for aluminium-cable lugs and connectors  
acc. to DIN 46329/46267 part 2, crimping width 7 mm

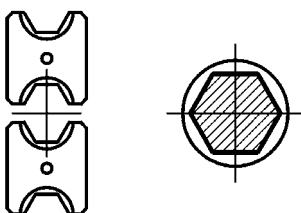

Part-No.	cross-section mm <sup>2</sup>	code-no.	information
12324	16/25 + 35	12 Al + 14 Al	Suitable tools for cross-section up to 185 mm <sup>2</sup> 12930/12933 and 12728 and for cross-section up to 300 mm <sup>2</sup> 14240/42 and 12748
12325	16/25 + 50	12 Al + 16 Al	
12326	70	18 Al	
12327	95/120	22 Al	
12328	150	25 Al	
12329	185	28 Al	
12330	240	32 Al	
12331	300	34 Al	

### Round-crimping dies 25/35-185/240 mm<sup>2</sup>

for sector shaped copper and aluminium conductors,  
crimping width 12 mm

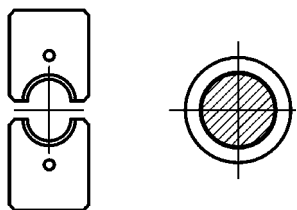

Part-No.	cross-section mm <sup>2</sup>		information
	sm	se	
12955	25	35	Suitable tools for all cross-section ranges 12930, 12933, 14240/42, 12748 and 12728
12956	35	50	
12957	50	70	
12958	70	95	
12959	95	120	
12960	120	150	
12961	150	185	
12962	185	240	

### Trapezoid crimping 10-95 mm<sup>2</sup>

for cable end sleeves acc. to DIN 46228 part 1 + 4,  
crimping width 20 mm

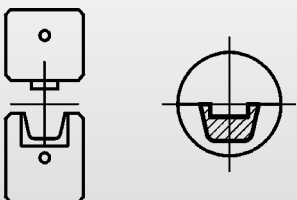

Best.-Nr.	Querschnitt mm <sup>2</sup>	Hinweis
12111	10	Suitable tools for all cross-section ranges 12930/12933, 14240/42 and 12728.
12112	16	
12113	25	
12114	35	
12115	50	
12116	70	
12117	95	

**System dies size II (half shell dies, small design)**

suitable for hand operated crimping tool with telescoping handles Part No. 12869 acc. to catalogue page no. 162 and hydraulic compression tool Part-No. 12766 acc. to catalogue page 172, battery operated hydraulic tools 14240/41 acc. to catalogue page 176, Part No. 12724 acc. to catalogue page no. 191 resp. 13552 acc. to catalogue page 180 and hydraulic compression head Part No. 12836 acc. to catalogue page 199

**Indent-crimping 10-120 mm<sup>2</sup>**

for cable lugs acc. to DIN 46234 + 46230

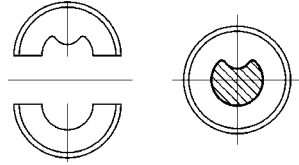

Part-No.	cross-section mm <sup>2</sup>	information
12577	10	Suitable tools for all cross-section ranges 12766, 12869, 12724, 14240/41, 13552 and 12836.
12578	16	
12579	25	
12580	35	
12581	50	
12582	70	
12583	95	
12584	120	

**Indent-crimping 1,5-35 mm<sup>2</sup>**

for druseidt stainless steel cable lugs

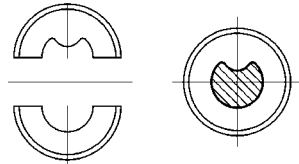

Part-No.	cross-section mm <sup>2</sup>	information
12585	1,5 - 2,5	Suitable tools for all cross-section ranges 12766, 12869, 12724, 14240/41, 13552 and 12836. Up a cross-section range of 35 mm <sup>2</sup> it is necessary to work for copper and stainless steel cables with different crimping dies.
12586	4 - 6	
12587	10	
12588	16	
12590	25	
12591/VA	35	
12591/CU	35	

**WM-crimping 10-300 mm<sup>2</sup>**

for tubular cable lugs and connectors  
druseidt standard design, crimping width 5 mm

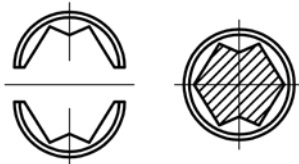

Part-No.	cross-section mm <sup>2</sup>	information
13963	10	Suitable tools for all cross-section ranges 12766, 12869, 12724, 14240/41, 13552 and 12836.
13964	16	
13965	25	
13966	35	
13967	50	
13968	70	
13969	95	
13970	120	
13971	150	
13972	185	
13973	240	
13974	300	

**WM-crimping 10-300 mm<sup>2</sup>**

for tubular cable lugs and connectors  
druseidt Euro-type design

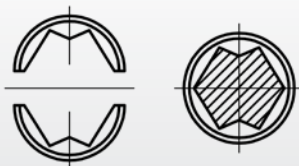

Part-No.	cross-section mm <sup>2</sup>	information
13975	10	Suitable tools for all cross-section ranges 12766, 12869, 12724, 14240/41, 13552 and 12836.
13976	16	
13977	25	
13978	35	
13979	50	
13980	70	
13981	95	
13982	120	
13971	150	
13972	185	
13973	240	
13974	300	



## System dies size II (half shell dies, small design)

### WM-crimping 10f-240f mm<sup>2</sup>

for tubular cable lugs and connectors  
druseidt design for fine stranded cables,  
crimping width 5 mm

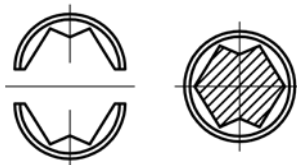

### Hexagonal-crimping 6-240/300 mm<sup>2</sup>

for copper cable lugs and connectors acc. to DIN 46235/46267 part 1  
and out of aluminium acc. to DIN 46329/46267, part 2,  
crimping width 5 mm

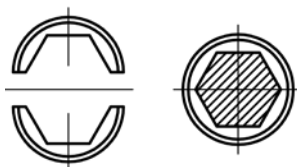

### Round-crimping dies 25/35-185/240 mm<sup>2</sup>

for sector-shaped copper- and aluminium conductors,  
crimping width 12 mm

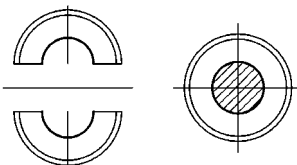

### Trapezoid-crimping 10-240 mm<sup>2</sup>

for cable end sleeves acc. to DIN 46228 part 1 + 4,  
crimping width 20 mm

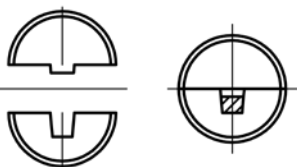

### Trapezoid-crimping 2 x 4 up to 2 x 16 mm<sup>2</sup>

for Twin cable end sleeves,  
crimping width 20 mm



Part-No.	cross-section mm <sup>2</sup>	information
13485	10f	Suitable tools for all cross-section ranges 12766, 12869, 12724, 14240/41, 13553 and 12836.
13486	16f	
13487	25f	
13488	35f	
13489	50f	
13490	70f	
13491	95f	
13492	120f	
13493	150f	
13494	185f	
13495	240f	

Part-No.	cross-section mm <sup>2</sup>		code-no.	information
	Cu	Al		
13987	6	-	5	Suitable tools for all cross-section ranges 12766, 12869, 12724, 14240/41, 13553 and 12836.
13988	10	-	6	
13989	16	-	8	
13990	25	-	10	
13991	35	16 + 25	12	
13992	50	35	14	
13993	70	50	16	
13994	95	70	18	
13995	120	-	20	
13996	150	95 + 120	22	
13997	185	150	25	
13998	240	185	28	
13999	300	240	32	

Part-No.	cross-section mm <sup>2</sup>		information
	sm	se	
14140	25	35	Suitable tools for all cross-section ranges 12766, 12869, 12724, 14240/41, 13553 and 12836.
14141	35	50	
14142	50	70	
14143	70	95	
14144	95	120	
14145	120	150	
14146	150	185	
14147	185	240	

Part-No.	cross-section mm <sup>2</sup>	information
13909	10	Suitable tools for all cross-section ranges 12766, 12869, 12724, 14240/41, 13553 and 12836.
13910	16	
13911	25	
13912	35	
13913	50	
13914	70	
13915	95	
13916	120	
13917	150	
13918	185	
13918	240	

Part-No.	cross-section mm <sup>2</sup>	information
14148	2 x 4	Suitable tools for all cross-section ranges 12766, 12869, 12724, 14240/41, 13553 and 12836.
14149	2 x 6	
14150	2 x 10	
14151	2 x 16	

**System dies size III (half shell dies, large design)**

suitable for hand operated hydraulic compression tools Part-No. 12965/S and 12968 acc. to catalogue page 172, battery operated hydraulic compression tools 13551/25, 13551/42 and 13537 acc. to catalogue page 183 and hydraulic compression heads 12485 acc. to catalogue page 199 resp. tabletop unit 12837 acc. to catalogue page 200

**Indent-crimping 10-240 mm<sup>2</sup>**

for cable lugs acc. to DIN 46234 + 46230

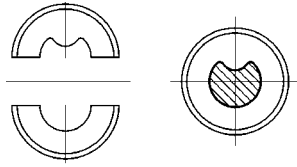

Part-No.	cross-section mm <sup>2</sup>	information
14120	10	When ordering the dies 14120-30 it is necessary to order the suitable indenter too. Suitable tools for all cross-section ranges 12965/S, 12968, 13551/25, 13551/42, 13537, 12485, 12837
14121	16	
14122	25	
14123	35	
14124	50	
14125	70	
14126	95	
14127	120	
14128	150	
14129	185	
14130	240	
<b>Indenter</b>		
14131	10 - 35	
14132	50 - 95	
14133	120 - 240	

**Indent-crimping 10-95 mm<sup>2</sup>**

for druseidt stainless steel cable lugs

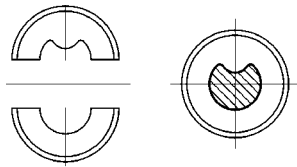

Part-No.	cross-section mm <sup>2</sup>	information
14163	10	Suitable tools for all cross-section ranges 12965/S, 12968, 13551/25, 13551/42, 13537, 12485, 12837 The crimping dies 14166/VA-14169/VA are suitable for crimping stainless steel cables and the dies 14166/CU-14169/CU for crimping copper cables with stainless steel lugs. When crimping cross-sections up to 25 mm <sup>2</sup> copper- and stainless steel cables can be crimped with the same die-set.
14164	16	
14165	25	
14166/VA	35	
14166/CU	35	
14167/VA	50	
14167/CU	50	
14168/VA	70	
14168/CU	70	
14169/VA	95	
14169/CU	95	

**WM-crimping 10-300 mm<sup>2</sup>**

for tubular cable lugs and connectors druseidt standard design

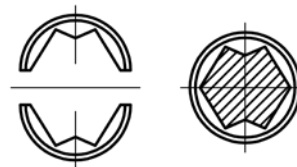

Part-No.	cross-section mm <sup>2</sup>	crimping width	information
13048	10	7	Suitable tools for all cross-section ranges 12965/S, 12968, 13551/25, 13551/42, 13537, 12485, 12837
13049	16	7	
13050	25	10	
13051	35	12	
13052	50	14	
13053	70	14	
13054	95	14	
13055	120	14	
13056	150	14	
13057	185	14	
13058	240	14	
13059	300	7	

**WM-crimping 10-300 mm<sup>2</sup>**

for tubular cable lugs and connectors druseidt Euro-design

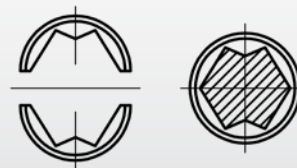

Part-No.	cross-section mm <sup>2</sup>	crimping width	information
14170	10	7	Suitable tools for all cross-section ranges 12965/S, 12968, 13551/25, 13551/42, 13537, 12485, 12837
14171	16	7	
14172	25	12	
14173	35	12	
14174	50	14	
14175	70	14	
14176	95	14	
14177	120	14	
13056	150	14	
13057	185	14	
13058	240	14	
13059	300	7	

## System dies size III (half shell dies, large design)

### WM-crimping 10f-240f mm<sup>2</sup>

for tubular cable lugs and connectors  
druseidt design for fine stranded cables

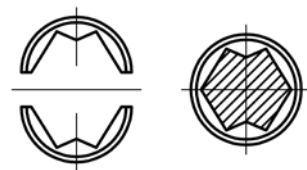

Part-No.	cross-section mm <sup>2</sup>	crimping width	information
13540	10f	7	Suitable tools for all cross-section ranges 12965/S, 12968, 13551/25, 13551/42, 13537, 12485, 12837
13541	16f	10	
13542	25f	12	
13543	35f	14	
13544	50f	14	
13545	70f	14	
13546	95f	14	
13547	120f	14	
13548	150f	14	
13549	185f	14	
13550	240f	7	

### Hexagonal-crimping 10-300 mm<sup>2</sup>

for copper cable lugs and connectors acc. to DIN 46235/46267 part 1  
and aluminium acc. to DIN 46329/46267 part 2

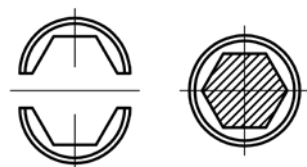

Part-No.	cross-section mm <sup>2</sup>		code-no.	crimping width
	Cu	Al		
12980	10	-	6	7
12981	16	-	8	14
12982	25	-	10	14
12983	35	16/25	12	12
12984	50	35	14	12
12985	70	50	16	12
12986	95	70	18	12
12987	120	-	20	12
12988	150	95/120	22	14
12989	185	150	25	14
12990	240	185	28	14
12991	300	240	32	7
12992/300	-	300	34	7

**Information:** Suitable tools for all cross-section ranges 12965/S, 12968, 13551/25, 13551/42, 13537, 12485, 12837

### Round-crimping dies 25/35-240/300 mm<sup>2</sup>

for sector shaped copper- and aluminium conductors,  
crimping width 35 mm

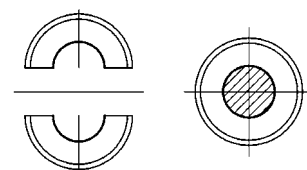

Part-No.	cross-section mm <sup>2</sup>		information
	sm	se	
12992	25	35	Suitable tools for all cross-section ranges 12965/S, 12968, 13551/25, 13551/42, 13537, 12485, 12837
12993	35	50	
12994	50	70	
12995	70	95	
12996	95	120	
12997	120	150	
12998	150	185	
12999	185	240	
12907	240	300	

### Trapezoid-crimping 25-185 mm<sup>2</sup>

for cable end sleeves DIN 46228 part 1 + 4



Part-No.	cross-section mm <sup>2</sup>	crimping width	information
14152	25	20	Suitable tools for all cross-section ranges 12965/S, 12968, 13551/25, 13551/42, 13537, 12485, 12837
14153	35	20	
14154	50	26	
14155	70	26	
14156	95	26	
14157	120	26	
14158	150	26	
14159	185	26	

## Exchangeable crimping dies for crimping head 05256 / 250 kN

**WM-Crimping 10-630 mm<sup>2</sup>**  
for tubular cable lugs and connectors  
druseidt standard design

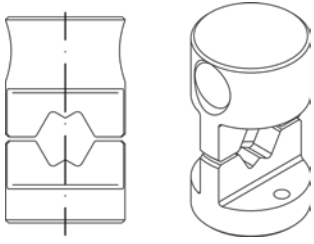

WM-Crimping

Part-No.	cross-section mm	crimping width mm
12135	10	7
12136	16	7
12137	25	10
12138	35	12
12139	50	14
12140	70	14
12141	95	14
12142	120	14
12143	150	14
12144	185	14
12145	240	14
12918/UL	300	14
12919/UL	400	14
12920/UL	500	14
12149	630	14

**WM-Crimping 10-630 mm<sup>2</sup>**  
for tubular cable lugs and connectors  
druseidt Euro-design

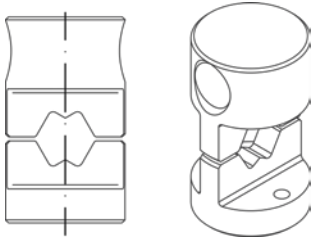

WM-Crimping

Part-No.	cross-section mm	crimping width mm
14178	10	7
14179	16	7
14180	25	12
14181	35	12
14182	50	14
14183	70	14
14184	95	14
14185	120	14
12143	150	14
12144	185	14
12145	240	14
12918/UL	300	14
12919/UL	400	14
12920/UL	500	14
12149	630	14

**WM-Crimping 10-300 mm<sup>2</sup>**  
for tubular cable lugs and connectors  
druseidt design for fine stranded cables

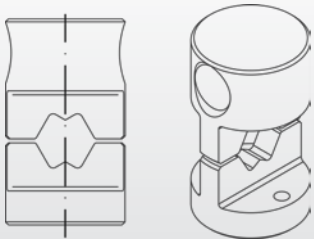

WM-Crimping

Part-No.	cross-section mm	crimping width mm
14250	10f	7
14251	16f	10
14252	25f	12
14253	35f	14
14254	50f	14
14255	70f	14
14256	95f	14
14257	120f	14
14258	150f	14
14259	185f	14
14260	240f	14
14261	300f	14



### Exchangeable crimping dies for crimping head 05256 / 250 kN

#### Hexagonal crimping 10-630 mm<sup>2</sup>

for copper- and aluminium cable lugs and connectors  
according to DIN 46235/46267 part 1, DIN 46329 / 46267 part 2

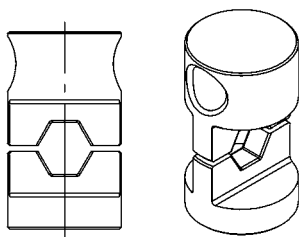

Hexagonal-crimping

Part-No.	cross-section mm <sup>2</sup>		code-no.	crimping width mm
	Cu	Al		
12533	10	-	6	5
12908	16	-	8	14
12909	25	-	10	14
12910	35	16/25	12	12
12911	50	35	14	12
12912	70	50	16	12
12913	95	70	18	12
12914	120	-	20	12
12915	150	95/120	22	14
12916	185	150	25	14
12917	240	185	28	14
12918	300	240	32	12
12918/Al	-	300	34	17
12919	400	400	38	17
12920	500	-	42	17
12921	630	500	44	17

### Round-crimping dies 25/35-300/400 mm<sup>2</sup>

for sector-shaped copper- and aluminium dies

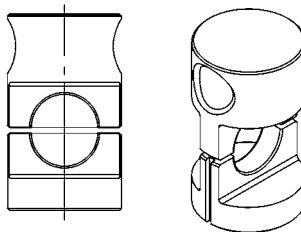

Round-crimping

Part-No.	cross-section mm <sup>2</sup>		crimping width mm
	sm	se	
12520	25	35	40
12521	35	50	40
12522	50	70	40
12523	70	95	40
12524	95	120	40
12525	120	150	40
12526	150	185	40
12527	185	240	40
12528	240	300	40
12529	300	400	40

### Exchangeable crimping dies for crimping head 12491 / 450 kN

#### Hexagonal crimping 95-1000 mm<sup>2</sup>

for copper- and aluminium cables and connectors  
according to DIN 46235/46267 part 1, DIN 46329/46267 part 2

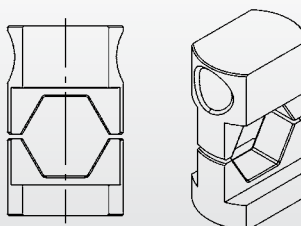

Hexagonal-crimping

Part-No.	cross-section mm <sup>2</sup>		code-no.	crimping width mm
	Cu	Al		
12534	95	70	18	12
12535	120	-	20	14
12536	150	95/120	22	14
12538	185	150	25	14
12539	240	185	28	14
12540	300	240	32	17
12540/Al	-	300	34	17
12541	400	400	38	17
12542	500	-	42	17
12543	630	500	44	17
12544	800	630	52	25
12545	1000	800	58	25
12546	-	1000	60	25

# 3. TECHNICAL APPENDIX

## Instructions for crimping our cable lugs and connectors

Following we give some information about suitable tools and the realization of the crimping process when working with our cable lugs and connectors. **Please notice, that it is absolutely necessary to pay attention to the fact that cable connector, tool and die set are well suited to each other. Only under this condition it is possible to guarantee optimal solderless crimped connections. Therefore we recommend to work only with the suitable druseidt tools.**

To take notice of the various kinds of applications and the number of crimping operations we offer tools in a different price- and performance level. Generally we recommend only to work with ratchet assisted tools, especially when working in the industrial field. So it is possible to guarantee a constant crimping force and optimal crimping performance all over the time. Also we recommend to inspect the tools every year (by permanent working shorter periods after agreement).

With pleasure we'll check and repair your tools in our company. Please notice that it's not allowed to make any changes on our tools. It is not possible to give any form of guarantee by improper handling, incorrect repairing or changed tools. All cable lugs, connectors and tools are constructed for the crimping of stranded copper- and aluminium-conductors. By working with massive single wire conductors or cables made out of other materials it is necessary to consult our company. Our company offers a wide range of cable connectors. Based on this fact it is not possible to write down crimping instructions for all of the different kinds of conductors described in this catalogue. Therefore please be so kind and contact us in case of doubt. With pleasure our employees assist your company to find an optimal crimping solution for your application.

## Direction for crimping cable lugs and connectors

A general instruction is that cable lugs or connectors and the used cable must have the same cross-section. By working with fine stranded cables with a bigger outer-Ø it is necessary to work with cable lugs for fine stranded cables (described in this catalogue on pages 35-39) or cable lugs with a bigger cross-section as the cable. To work with cable lugs with a smaller cross-section as the cable is not allowed.

To guarantee an optimal filling of the crimp sleeve it is necessary that the difference of the inner-Ø of the sleeve and the outer-Ø of the stripped cable is not to much. You get an optimal crimping performance when the inner-Ø of the sleeve and the outer-Ø of the cable is nearly the same. The dimension of the cable lugs and connectors are described in our catalogue. Please compare these dimensions with the outer-Ø of your stripped cable.

### Crimping procedure by working with tubular cable lugs and connectors:

- cutting of the cable (right angled to the conductor).
- stripping of the cable. Stripping length = length of the crimp sleeve + ca. 10 %, caused of the sleeve stretching when crimping.
- before starting the crimping process it is necessary to clean the stripped cable ends and make it free of dirt and oxides. Sector shaped cables must be rounded with special dies.
- insertion of the cable. By working with cable lugs up to the end of the crimping sleeve, by working with connectors up to the centre of the connector.
- checking up that cable lug or connector, tool and die set are the right ones.
- take also notice of the instructions for use of the crimping tool.
- realizing of the crimping process. Beginning from the flange of the cable lug in the direction to the conductor or by working with connectors from the connector-centre in the direction to the conductor (acc. to the following drawing). Number of crimpings in dependence of the crimping width and length of the crimping sleeves (please take also notice of the instructions on page 203).

### Crimping direction by realizing the crimping process:

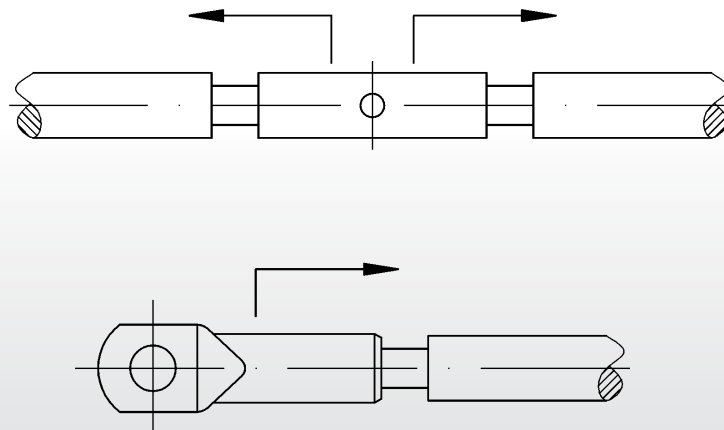

## Number of crimpings

When working with tubular cable lugs and connectors the number of crimpings are in dependence of the used tool and the crimping width of the die sets. Such information are given in our tables and the description in this catalogue.

The recommend min. number of crimpings are contained in the following tables. When working with butt connectors it is necessary to double it. When crimping cable lugs please pay attention to our instructions on page 202 too.

cross-section mm <sup>2</sup>	number x crimping width				
	druseidt standard design	druseidt Euro-design	druseidt design for fine stranded cables	copper DIN-design 46235 / 46267/1	aluminium DIN-design 46239 / 46267/2
10	1 x 5 mm	1 x 5 mm	1 x 5 mm	1 x 5 mm	-
	1 x 7 mm	1 x 7 mm	1 x 7 mm	1 x 7 mm	-
16	1 x 5 mm	2 x 5 mm	2 x 5 mm	2 x 5 mm	3 x 5 mm
	1 x 7 mm	1 x 7 mm	1 x 10 mm	1 x 14 mm	2 x 7 mm
					1 x 12 mm
25	2 x 5 mm	2 x 5 mm	2 x 5 mm	2 x 5 mm	4 x 5 mm
	1 x 10 mm	1 x 12 mm	1 x 12 mm	2 x 7 mm	3 x 7 mm
				1 x 14 mm	2 x 12 mm
35	2 x 5 mm	2 x 5 mm	2 x 5 mm	2 x 5 mm	5 x 5 mm
	2 x 7 mm	2 x 7 mm	2 x 7 mm	2 x 7 mm	4 x 7 mm
	1 x 12 mm	1 x 12 mm	1 x 14 mm	1 x 12 mm	2 x 12 mm
50	2 x 5 mm	2 x 5 mm	2 x 5 mm	3 x 5 mm	5 x 5 mm
	2 x 7 mm	2 x 7 mm	2 x 7 mm	2 x 7 mm	4 x 7 mm
	1 x 12 mm	1 x 12 mm	1 x 14 mm	1 x 12 mm	2 x 12 mm
70	2 x 5 mm	2 x 5 mm	3 x 5 mm	3 x 5 mm	7 x 5 mm
	2 x 7 mm	2 x 7 mm	2 x 7 mm	2 x 7 mm	5 x 7 mm
	1 x 14 mm	1 x 14 mm	1 x 14 mm	1 x 12 mm	3 x 12 mm
95	3 x 5 mm	3 x 5 mm	3 x 5 mm	4 x 5 mm	7 x 5 mm
	2 x 7 mm	2 x 7 mm	2 x 7 mm	3 x 7 mm	5 x 7 mm
	1 x 14 mm	1 x 14 mm	1 x 14 mm	2 x 12 mm	3 x 12 mm
120	3 x 5 mm	3 x 5 mm	3 x 5 mm	4 x 5 mm	7 x 5 mm
	2 x 7 mm	2 x 7 mm	2 x 7 mm	2 x 7 mm	5 x 7 mm
	1 x 14 mm	1 x 14 mm	1 x 14 mm	2 x 12 mm	3 x 12 mm
150	3 x 5 mm	3 x 5 mm	3 x 5 mm	4 x 5 mm	7 x 5 mm
	2 x 7 mm	2 x 7 mm	2 x 7 mm	3 x 7 mm	5 x 7 mm
	1 x 14 mm	1 x 14 mm	1 x 14 mm	2 x 14 mm	3 x 12 mm
185	3 x 5 mm	3 x 5 mm	4 x 5 mm	4 x 5 mm	7 x 5 mm
	2 x 7 mm	2 x 7 mm	3 x 7 mm	3 x 7 mm	5 x 7 mm
	1 x 14 mm	1 x 14 mm	2 x 14 mm	2 x 14 mm	3 x 12 mm
240	4 x 5 mm	4 x 5 mm	5 x 5 mm	5 x 5 mm	8 x 5 mm
	3 x 7 mm	3 x 7 mm	4 x 7 mm	4 x 7 mm	6 x 7 mm
	2 x 14 mm	2 x 14 mm	2 x 14 mm	2 x 14 mm	3 x 12 mm
300	4 x 5 mm	4 x 5 mm	-	5 x 5 mm	8 x 5 mm
	3 x 7 mm	3 x 7 mm	-	4 x 7 mm	6 x 7 mm
	2 x 14 mm	2 x 14 mm	-	2 x 14 mm	3 x 12 mm
400	2 x 14 mm	2 x 14 mm	-	3 x 17 mm	3 x 17 mm
500	3 x 14 mm	3 x 14 mm	-	3 x 17 mm	4 x 17 mm
630	3 x 14 mm	3 x 14 mm	-	3 x 17 mm	4 x 17 mm
800	-	-	-	3 x 25 mm	4 x 25 mm
1000	-	-	-	3 x 25 mm	4 x 25 mm

## Maximum allowable current load of cable lugs and connectors in conjunction with insulated leadings and conductors

The current load of cable lugs and connectors depends on the regulations of the VDE 0298 part 4 where the allowable current load of leadings and cables are regulated. Following a summary of some most used situations.

**Group 1:** Leadings up to a nominal voltage 1 kV and heat resistant leadings acc. to VDE 0298 part 4 table 11 column 2. Air-cooled single wire leadings, rubber-insulated, PVC-insulated, heat resistant.

**Group 2:** Leadings up to a nominal voltage of 1 kV and heat resistant leadings acc. to VDE 0298 part 4 column 5. Multi-conductor leadings (but not for household appliance and hand-hold units) layed on or of free areas, rubber insulated, PVC-insulated, heat resistant.

The information about current load apply by an ambient temperature of +30° C in dependence of the laying system of the cables.

**Group 3:** Leadings with a nominal voltage of 0,6/1 kV acc. to VDE 0298 part 4, column 7. Rubber insulated leadings 0,6/1 kV and 1,8/3 kV in special design (air cooled laying).

**Group 4:** Leadings with a nominal voltage of 0,6/1 kV acc. to VDE 0298, part 4 column 4. Multi conductor leadings rubber tube insulated and trailing cables up to 6/10 kV layed on or of free areas.

nominal cross-section mm <sup>2</sup>	current load for copper cables in ampere			
	Group 1	Group 2	Group 3	Group 4
0,75	15	12	-	-
1	19	15	-	-
1,5	24	18	30	-
2,5	32	26	41	30
4	42	34	55	41
6	54	44	70	53
10	73	61	98	74
16	98	82	132	99
25	129	108	176	131
35	158	135	218	162
50	198	168	276	202
70	245	207	347	250
95	292	250	416	301
120	344	292	488	352
150	391	335	566	404
185	448	382	644	461
240	528	453	775	-
300	608	523	898	-
400	726	-	-	-
500	830	-	-	-

**Remark:** Design of the leadings resp. all values deviates from VDE 0298 part 4 dated August 2003 and are only valid under the conditions of the VDE-regulations.

## Tightening torques for screws

acc. to DIN EN 61238/DIN VDE 0220 part 2 for screws 8.8

thread M	tightening torque Nm
5	5
6	9
8	22
10	44

thread M	tightening torque Nm
12	75
14	120
16	190
20	380



## Tightening force for leadings and cables

The tightening force is the identified value to pull out a leading or cable out of the crimped connector. The values deliver information about the mechanical stress of crimping connections. In dependence of the different cable lugs and connectors we have different regulations about the minimum tightening forces for crimping connections.

To pass the test acc. to the different norms and regulations it is necessary that the electrical conductor cannot pulled out inside of 60 seconds when testing with 100 % of the tightening force. Following a summary of such values under consideration of the different norms.

	Values for crimping copper connectors up to 10 mm <sup>2</sup> DIN EN 61238-1, 3/2004 (VDE 0220 part 100) except cable end sleeves			Values for crimping aluminium connectors up to 16 mm <sup>2</sup> DIN EN 61238-1, 03/2004 (VDE 0220 part 100)		
	100%	130%	150%	100%	130%	150%
10 mm <sup>2</sup>	600 N	780 N	900 N	-	-	-
16 mm <sup>2</sup>	960 N	1248 N	1440 N	640 N	832 N	960 N
25 mm <sup>2</sup>	1500 N	1950 N	2250 N	1000 N	1300 N	1500 N
35 mm <sup>2</sup>	2100 N	2730 N	3150 N	1400 N	1820 N	2100 N
50 mm <sup>2</sup>	3000 N	3900 N	4500 N	2000 N	2600 N	3000 N
70 mm <sup>2</sup>	4200 N	5460 N	6300 N	2800 N	3640 N	4200 N
95 mm <sup>2</sup>	5700 N	7410 N	8550 N	3800 N	4940 N	5700 N
120 mm <sup>2</sup>	7200 N	9360 N	10800 N	4800 N	6240 N	7200 N
150 mm <sup>2</sup>	9000 N	11700 N	13500 N	6000 N	7800 N	9000 N
185 mm <sup>2</sup>	11100 N	14430 N	16550 N	7400 N	9620 N	11100 N
240 mm <sup>2</sup>	14400 N	18720 N	21600 N	9600 N	12480 N	14400 N
300 mm <sup>2</sup>	18000 N	23400 N	27000 N	12000 N	15600 N	18000 N
400 mm <sup>2</sup>	24000 N*			16000 N	20800 N	24000 N
500 mm <sup>2</sup>	30000 N*			20000 N	26000 N	30000 N
625 mm <sup>2</sup>	37500 N*			25000 N*		
800 mm <sup>2</sup>	48000 N*			32000 N*		
1000 mm <sup>2</sup>	60000 N*			40000 N*		

\* VDE 0220 part 100: maximum value is limited up to 20000 N

cross-section	Values for crimp connections up to 10 mm <sup>2</sup> EN 60352 part 2, 10/2002 except cable end sleeves			Values for connections with tabs and receptacles in combination with copper conductors DIN EN 61210 (VDE 0613 part 6), 06/2011		
	100%	130%	150%	100%		
0,2 mm <sup>2</sup>	-	-	-	28 N		
0,34 mm <sup>2</sup>	-	-	-	40 N		
0,5 mm <sup>2</sup>	60 N	78 N	90 N	56 N		
0,75 mm <sup>2</sup>	85 N	111 N	128 N	84 N		
1 mm <sup>2</sup>	108 N	140 N	162 N	108 N		
1,5 mm <sup>2</sup>	150 N	195 N	225 N	150 N		
2,5 mm <sup>2</sup>	230 N	299 N	345 N	230 N		
4 mm <sup>2</sup>	310 M	403 N	465 N	310 N		
6 mm <sup>2</sup>	360 N	468 N	540 N	360 N		
10 mm <sup>2</sup>	380 N	494 N	570 N	-		

cross-section	Values for cable end sleeves		cross-section	Values for cable end sleeves	
	EN 60947-1 (VDE 0660 part 100) release 04/2008	EN 60999-1 release 12/2000		EN 60947-1 (VDE 0660 part 100) release 04/2008	EN 60999-2 release 4/2004
0,2 mm <sup>2</sup>	10 N	10 N	50 mm <sup>2</sup>	236 N	236 N
0,34 mm <sup>2</sup>	15 N	15 N	70 mm <sup>2</sup>	285 N	285 N
0,5 mm <sup>2</sup>	20 N	20 N	95 mm <sup>2</sup>	351 N	351 N
0,75 mm <sup>2</sup>	30 N	30 N	120 mm <sup>2</sup>	427 N	427 N
1 mm <sup>2</sup>	35 N	35 N	150 mm <sup>2</sup>	427 N	427 N
1,5 mm <sup>2</sup>	40 N	40 N	185 mm <sup>2</sup>	503 N	503 N
2,5 mm <sup>2</sup>	50 N	50 N	240 mm <sup>2</sup>	578 N	578 N
4 mm <sup>2</sup>	60 N	60 N			
6 mm <sup>2</sup>	80 N	80 N			
10 mm <sup>2</sup>	90 N	90 N			
16 mm <sup>2</sup>	100 N	100 N			
25 mm <sup>2</sup>	135 N	135 N			
35 mm <sup>2</sup>	190 N	190 N			

## Temperature resistance of cable lugs and connectors

copper cable lugs without insulation	up to + 120° C
uninsulated cable end sleeves	up to + 120° C
cable lugs and connectors with PA-insulation	up to + 105° C
cable lugs and connectors with PC-insulation	up to + 100° C
cable lugs and connectors with PVC-insulation	up to + 70° C
cable lugs and connectors with shrinking insulation	up to + 95° C
insulated cable end sleeves	up to + 105° C

cable lugs and connectors out of nickel	up to + 500° C
cable lugs and connectors out of stainless steel	up to + 400° C
uninsulated tabs and receptacles, brass, uncoated	up to + 90° C
uninsulated tabs and receptacles, brass, tin plated	up to + 100° C
uninsulated tabs and receptacles, brass, silver plated	up to + 110° C
uninsulated tabs and receptacles, brass, nickel plated	up to + 250° C

## Conductor cross-section comparison

AWG	30	29	28	27	26	25	24	23	22	21	20	19
cross-section mm <sup>2</sup>	0,0503	0,0646	0,0804	0,102	0,128	0,163	0,205	0,259	0,325	0,412	0,519	0,653
comparable metrical cross-section	0,05	-	-	0,1	0,14	-	0,2	0,25	-	-	0,5	-

AWG	18	17	16	15	14	13	12	11	10	9	8	7
cross-section mm <sup>2</sup>	0,823	1,04	1,31	1,65	2,08	2,63	3,31	4,15	5,27	6,62	8,35	10,6
comparable metrical cross-section	0,75	1	-	1,5	-	2,5	-	-	-	6	-	10

AWG	6	5	4	3	2	1	0	2/0	3/0	4/0	5/0	6/0
cross-section mm <sup>2</sup>	13,3	16,8	21,2	26,7	33,6	42,4	53,4	67,5	85,0	107,2	135,1	170,3
comparable metrical cross-section	-	16	-	25	35	-	50	70	95	120	150	185

## Inspection and repair of crimping tools

In dependence of the frequency of use and the environmental influences crimping tools are subject of abrasion. Therefore we recommend to inspect the tools every year (by permanent working shorter periods after agreement). With pleasure we'll check and repair your tools in our company. Please notice that tools delivered by druseidt may not be changed in any way.

In particular it is not allowed to make diameter holes etc. Please use our tools only in accordance with our description and the regulations. Repairs of tools may only be executed by our service-department. With pleasure our employees assist your company in repairing and inspecting tools as well as in finding optimal crimping solutions.

## Numerical Index

Part-No.	page	Part-No.	page	Part-No.	page	Part-No.	page	Part-No.	page	Part-No.	page	Part-No.	page		
01000.01	14	01106	18	01359	24	01488.01.02	16	01605	30	01716	31	01818	32	01924 bl	50
01001.01	14	01107	18	01360	24	01489.01.02	16	01606	30	01716	43	01818/S-45	33	01925	50
01002.01	14	01108	18	01362	24	01490.01.02	16	01607	30	01717	31	01819	32	01925 bl	50
01003.01	14	01109	18	01363	24	01491.01.02	16	01608	30	01717	43	01819/S-45	33	01926	50
01005	14	01110	18	01364	24	01492.01.02	16	01609	30	01718	31	01820	32	01926 bl	50
01005.01	14	01111	18	01365	24	01493.01.02	16	01610	30	01718	43	01820/S-45	33	01927	50
01006.01.02	14	01117	19	01366	24	01494.01.02	16	01611	30	01719	31	01821	32	01927 bl	50
01007.01.02	14	01118	19	01367	24	01495.01.02	16	01612	30	01719	43	01821/S-45	33	01928	50
01008.01.02	14	01120	19	01368	24	01496.01.02	16	01613	30	01720	31	01822	32	01928 bl	50
01009	14	01122	19	01369	24	01497.01.02	16	01614	30	01720	43	01822/S-45	33	01929	50
01009.01	14	01123	19	01370	24	01498.01.02	16	01615	30	01721	31	01823	32	01929 bl	50
01010.01.02	14	01124	19	01371	24	01499.01.02	16	01616	30	01721	43	01823/S-45	33	01930	50
01011	14	01130	20	01372	24	01501	26	01617	30	01722	31	01824	32	01930 bl	50
01011.01	14	01131	20	01373	24	01502	26	01618	30	01722	43	01824/S-45	33	01931	50
01012.01.02	14	01133	20	01374	24	01503	26	01619	30	01723	31	01825	32	01931 bl	50
01013.01.02	14	01140	20	01375	24	01504	26	01620	30	01723	43	01825/S-45	33	01932	50
01014	14	01141	20	01376	24	01506	26	01621	30	01724	31	01826	32	01932 bl	50
01014.01	14	01142	20	01377	24	01507	26	01622	31	01724	43	01826/S-45	33	01933	50
01015.01.02	14	01172	21	01378	24	01508	26	01623	31	01725	31	01827	32	01933 bl	50
01016.01.02	14	01173	21	01379	24	01509	26	01624	31	01725	43	01827/S-45	33	01934	50
01017.01.02	14	01174	21	01380	24	01510	26	01625	31	01726	31	01828	32	01934 bl	50
01018	14	01175	21	01381	24	01511	26	01626	31	01726	43	01828/S-45	33	01935	50
01018.01	14	01176	21	01382	24	01512	26	01627	31	01740	27	01829	32	01935 bl	50
01019	14	01179	21	01383	24	01513	26	01628	31	01741	27	01829/S-45	33	01936	50
01019.01	14	01180	21	01384	24	01516	26	01629	31	01742	27	01830	32	01936 bl	50
01020.01.02	14	01181	21	01385	24	01517	26	01630	31	01743	27	01830/S-45	33	01937	50
01021	14	01182	21	01386	24	01518	26	01631	31	01744	27	01831	33	01937 bl	50
01021.01	14	01183	21	01387	24	01521	26	01632	31	01745	27	01831/S-45	33	01938	50
01022.01.02	14	01186	21	01388	24	01522	26	01633	31	01746	27	01831/S-45	47	01938 bl	50
01023	14	01187	21	01389	24	01523	26	01634	31	01747	27	01832	33	01939	50
01023.01	14	01188	21	01390	24	01525	26	01634	43	01748	27	01832/S-45	33	01939 bl	50
01024.01.02	14	01189	21	01391	24	01526	26	01635	31	01749	27	01832/S-45	47	01940	50
01025.01.02	14	01190	21	01392	24	01527	26	01635	43	01750	27	01833	33	01940 bl	50
01026.01.02	14	01194	22	01393	24	01528	26	01636	31	01751	27	01833/S-45	33	01941	50
01027	14	01195	22	01394	24	01530	26	01636	43	01752	34	01833/S-45	47	01941 bl	50
01027.01	14	01196	22	01395	24	01531	26	01637	31	01752	48	01834	33	01942	50
01028.01.02	14	01197	22	01396	24	01533	26	01637	43	01753	34	01834/S-45	33	01942 bl	50
01029.01.02	14	01198	22	01397	25	01534	26	01638	31	01753	48	01834/S-45	47	01943	50
01030.01.02	14	01199	22	01398	25	01536	26	01638	43	01754	34	01835	33	01943 bl	50
01031.01.02	14	01206	66	01399	25	01537	26	01639	31	01754	48	01835/S-45	33	01944	50
01032.01.02	14	01207	66	01400	25	01538	26	01639	43	01755	34	01835/S-45	47	01944 bl	50
01033	14	01208	66	01401	25	01539	26	01640	31	01755	48	01836	33	01945	50
01033.01	14	01209	66	01402	25	01540	26	01640	43	01756	34	01836/S-45	33	01945 bl	50
01040.01	15	01210	66	01403	25	01541	26	01641	31	01756	48	01836/S-45	47	01946	50
01041.01.02	15	01211	66	01404	25	01542	26	01641	43	01757	34	01838	33	01946 bl	50
01042.01.02	15	01212	66	01405	25	01543	26	01642	31	01757	48	01838	46	01947	50
01044.01.02	15	01213	66	01406	25	01553	28	01642	43	01760	26	01840	33	01947 bl	50
01045.01.02	15	01214	66	01407	25	01554	28	01643	31	01761	26	01840	46	01948	50
01046.01.02	15	01215	66	01408	25	01555	28	01643	43	01762	26	01842	33	01948 bl	50
01048.01.02	15	01216	66	01409	25	01556	28	01644	31	01763	26	01842	46	01949	50
01050.01.02	15	01217	66	01410	25	01557	28	01644	43	01764	26	01850	32	01949 bl	50
01051.01.02	15	01218	66	01411	25	01558	28	01645	31	01765	26	01851	32	01950	50
01053.01.02	15	01219	66	01412	25	01559	28	01645	43	01766	26	01852	32	01950 bl	50
01054.01.02	15	01220	66	01413	25	01560	28	01646	31	01767	26	01853	32	01951	50
01055.01.02	15	01221	66	01414	25	01561	28	01646	43	01768	26	01854	32	01951 bl	50
01056.01.02	15	01222	66	01416	25	01562	28	01647	31	01769	26	01855	32	01952	50
01057.01.02	15	01223	66	01417	25	01563	28	01647	43	01770	26	01856	32	01952 bl	50
01058.01.02	15	01224	66	01430	25	01564	28	01648	31	01771	26	01857	32	01953	50
01059.01.02	15	01225	66	01431	25	01565	28	01648	43	01779	28	01858	32	01953 bl	50
01060.01.02	15	01226	66	01432	25	01566	28	01649	31	01780	28	01859	32	01954	50
01062.01.02	15	01227	66	01433	25	01567	28	01649	43	01781	28	01860	32	01954 bl	50
01063.01.02	15	01228	66	01434	25	01568	28	01650	31	01782	28	01861	32	01955	51
01070.01	15	01229	66	01435	25	01569	28	01650	43	01783	28	01862	32	01955 bl	51
01071.01.02	15	01230	66	01436	25	01570	28	01651	31	01784	28	01863	32	01956	51
01072	15	01231	66	01437	25	01571	28	01651	43	01785	28	01864	32	01956 bl	51
01072.01	15	01232	66	01438	25	01572	28	01652	31	01786	28	01865	32	01957	51
01073	15	01233	67	01439	25	01580	30	01652	43	01787	28	01866	32	01957 bl	51
01073.01	15	01234	67	01440	25	01580	42	01680	30	01788	28	01867	32	01958	51
01074.01.02	15	01235	67	01441	25	01581	30	01681	30	01789	28	01868	32	01958 bl	51
01076	15	01236	67	01442	25	01581	42	01682	30	01790	28	01869	32	01959	51
01076.01	15	01237	67	01443	25	01582	30	01683	30	01791	28	01870	32	01959 bl	51
01077.01.02	15	01238	67	01444	25	01582	42	01684	30	01792	28	01871	32	01960	51
01078.01.02	15	01300	67	01445	25	01583	30	01685	30	01800	32	01872	32	01960 bl	51
01079.01.02	15	01301	67	01446	25	01583	42	01686	30	01800/S-45	33	01873	32	01961	51
01080	17	01302	67	01447	25	01584	30	01687	30	01801	32	01874	32	01961 bl	51
01080.01	17	01303	67	01448	25	01584	42	01688	30	01801/S-45	33	01875	32	01962	51
01080.02	17	01305	71	01449	25	01585	30	01689	30	01802	32	01876	32	01962 bl	51
01081	17	01306	71	01450	25	01585	42	01690	30	01803	32	01877	32	01963	51
01081.01	17	01307	71	01452	25	01586	30	01691	30	01804	32	01878	32	01963 bl	51
01081.02	17	01308	71	01453	25	01586	42	01692	30	01804/S-45	33	01879	32	01964	53
01082	17	01309	71	01461.01.02	16	01588	30	01693	30	01805	32	01880	32	01965	53
01082.01	17	01310	71	01462.01.02	16	01588	42	01694	30	01805/S-45	33	01881	33	01966	53
01082.02															

## Numerical Index

Part-No.	page	Part-No.	page	Part-No.	page	Part-No.	page	Part-No.	page	Part-No.	page	Part-No.	page		
02004	51	02273	64	03090	102	03230	42	03456	37	03829/S-45	47	03926	44	04645 vz	81
02004 bl	51	02274	64	03091	102	03230/S	42	03458	37	03830	45	03927	44	04651 vz	81
02006	51	02275	64	03092	102	03231	42	03460	37	03831	45	03928	44	04660	81
02006 bl	51	02276	64	03093	102	03231/S	42	03462	37	03831/S-45	47	03929	44	04660 vz	81
02070	57	02277	64	03094	102	03232	42	03464	37	03832	45	03941	48	04686	81
02071	57	02278	64	03095	102	03232/S	42	03466	37	03832/S-45	47	03942	48	04707 vz	81
02072	57	02279	64	03097	102	03233	42	03468	37	03833	45	03943	48	04710 vz	81
02073	57	02280	64	03100	102	03233/S	42	03470	37	03833/S-45	47	03944	48	04711 vz	81
02074	57	02281	64	03108	102	03234	43	03472	37	03834	45	03945	48	04721 vz	82
02075	57	02282	64	03109	102	03234/S	43	03474	37	03834/S-45	47	03946	48	04722	82
02076	57	02283	64	03110	102	03235	43	03476	37	03835	45	03947	48	04790 vz	80
02077	57	02284	64	03111	102	03235/S	43	03480	37	03836	45	03948	48	04792 vz	80
02078	57	02285	64	03112	102	03236	43	03482	37	03836/S-45	47	03949	48	04794 vz	80
02079	57	02286	64	03113	102	03236/S	43	03484	37	03837	45	03950	48	04801 vz	80
02080	57	02287	64	03114	102	03237	43	03486	37	03837/S-45	47	03951	48	04802 vz	80
02100	34	02578	88	03116	102	03237/S	43	03490	37	03838	45	03952	48	04804 vz	80
02101	34	02580	88	03117	102	03238	43	03492	37	03838/S-45	47	03953	48	04850 vz	82
02102	34	02581	88	03118	102	03238/S	43	03494	37	03839	45	03954	48	04870	78
02105	34	02583	88	03119	102	03239	43	03496	37	03839/S-45	47	03955	48	04870 vz	78
02106	34	02584	88	03120	102	03239/S	43	03497	37	03840	45	03956	48	04872	78
02107	34	02585	88	03121	102	03240	43	03498	37	03841	45	03960	39	04875	78
02110	34	02586	88	03122	102	03240/S	43	03499	37	03842	46	03961	39	04875 vz	78
02111	34	02587	88	03136-	103	03241	43	03500	37	03842/S-45	47	03962	39	04877	78
02112	34	02588	88	03136+	103	03241/S	43	03501	37	03843	46	03963	39	04878	78
02113	34	02589	88	03137-	103	03242	43	03502	37	03843/S-45	47	03964	39	04878 vz	78
02115	34	02670	60	03137+	103	03242/S	43	03504	37	03844	46	03965	39	04880	78
02116	34	02671	60	03147	100	03243	43	03505	37	03844/S-45	47	03966	39	04883	78
02117	34	02672	60	03148	100	03243/S	43	03506	37	03845	46	03967	39	04883 vz	78
02118	34	02675	60	03165	48	03244	43	03575	88	03845/S-45	47	03968	39	04885	78
02121	34	02676	60	03166	48	03244/S	43	03576	88	03846	46	03969	39	04886	78
02122	34	02677	60	03167	48	03245	43	03696	83	03847	46	03970	39	04886 vz	78
02123	34	02678	60	03168	48	03245/S	43	03697	83	03848	46	03971	39	04888	78
02124	34	02679	60	03169	48	03246	43	03699	83	03849	46	03972	39	04888 vz	78
02127	34	02680	60	03170	48	03246/S	43	03703	83	03850	46	03973	39	04890	78
02128	34	02696	60	03171	48	03247	43	03707	83	03850/S-45	47	03974	39	04890 vz	78
02129	34	02697	60	03172	48	03247/S	43	03708	83	03851	46	03975	39	04892	78
02132	34	02698	60	03173	48	03248	43	03709	83	03851/S-45	47	03976	39	04892 vz	78
02133	34	02700	90	03196	42	03248/S	43	03710	83	03852	46	03977	39	04894	78
02134	34	02701	90	03196/S	42	03249	43	03711	83	03852/S-45	47	03978	39	04894 vz	78
02137	34	02702	90	03197	42	03249/S	43	03715	83	03853	46	03979	39	04896	78
02138	34	02703	90	03197/S	42	03250	43	03716	83	03854	46	03980	39	04896 vz	78
02139	34	02704	90	03198	42	03250/S	43	03717	83	03855	46	03981	39	04940	78
02150	54	02705	90	03198/S	42	03251	43	03718	83	03856	46	03982	39	04940 vz	78
02151	54	02706	90	03199	42	03251/S	43	03719	83	03856/S-45	47	03983	39	04945	78
02152	54	02707	90	03199/S	42	03252	43	03720	83	03857	46	03984	39	04945 vz	78
02153	54	02708	90	03200	42	03252/S	43	03721	83	03857/S-45	47	03985	39	04947	78
02154	54	02709	90	03200/S	42	03253	43	03722	83	03858	46	03986	39	04947 vz	78
02155	54	02710	90	03201	42	03253/S	43	03750	84	03858/S-45	47	03990	53	04980 vz	79
02156	54	02715	90	03201/S	42	03254	43	03751	84	03859	46	03990/vz	53	04982 vz	79
02157	54	02716	90	03202	42	03254/S	43	03752	84	03859/S-45	47	03991	53	05103	152
02158	54	02717	90	03202/S	42	03331	27	03753	84	03860	46	03991/vz	53	05103	158
02159	54	02718	90	03203	42	03332	27	03754	84	03861	46	03992	53	05116/N	154
02160	54	02719	90	03203/S	42	03333	27	03755	84	03861/S-45	47	03992/vz	53	05122	148
02161	54	02720	90	03204	42	03336	27	03756	84	03862	46	04058	82	05124	148
02162	54	02721	90	03204/S	42	03337	27	03757	84	03862/S-45	47	04058 vz	82	05125	148
02163	54	02722	90	03205	42	03338	27	03764	84	03863	46	04060	82	05126	160
02164	54	02723	90	03205/S	42	03339	27	03765	84	03863/S-45	47	04060 vz	82	05130	148
02165	54	02724	90	03206	42	03341	27	03775	85	03864	46	04063	82	05131	148
02166	54	02725	90	03206/S	42	03342	27	03776	85	03864/S-45	47	04063 vz	82	05140	149
02167	54	02730	90	03207	42	03343	27	03777	85	03865	46	04070	82	05141	149
02168	54	02731	90	03207/S	42	03344	27	03778	85	03865/S-45	47	04070 vz	82	05144	149
02169	54	02732	90	03208	42	03346	27	03779	85	03866	46	04072	82	05145	74
02170	54	02733	90	03208/S	42	03347	27	03780	85	03866/S-45	47	04072 vz	82	05146	74
02171	54	02734	90	03209	42	03348	27	03781	85	03867	46	04074	82	05147	74
02172	54	02735	90	03209/S	42	03349	27	03783	85	03867/S-45	47	04074 vz	82	05148	74
02173	54	02736	90	03210	42	03351	27	03785	85	03868	46	04076 vz	82	05149	74
02174	54	02737	90	03210/S	42	03352	27	03786	85	03868/S-45	47	04080 vz	82	05150	74
02175	54	02738	90	03211	42	03353	27	03787	85	03869	46	04083 vz	82	05151	74
02176	54	02739	90	03211/S	42	03354	27	03788	85	03869/S-45	47	04085 vz	82	05160	153
02177	54	02740	90	03212	42	03355	27	03789	85	03870	46	04245 vz	76	05161	153
02178	54	02745	90	03212/S	42	03356	27	03790	85	03871	46	04285	77	05162	153
02179	54	02746	90	03213	42	03357	27	03791	85	03872	46	04285 vz	77	05163	153
02180	54	02747	90	03213/S	42	03358	27	03800	38	03873	46	04287	77	05164	153
02181	54	02748	90	03214	42	03360	27	03801	38	03874	46	04287 vz	77	05165	153
02220	89	02749	90	03214/S	42	03361	27	03802	38	03875	46	04292 vz	77	05166	153
02221	89	02750	90	03215	42	03362	27	03803	38	03876	46	04296 vz	77	05167	153
02222	89	02751	90	03215/S	42	03365	27	03804	38	03877	46	04300 vz	76	05168	153
02223	89	02752	90	03216	42	03366	27	03805	38	03880/S-45	47	04305 vz	76	05169	153
02224	89	02753	90	03216/S	42	03367	27	03806	38	03881/S-45	47	04332 vz	77	05170	153
02225	89	02754	90	03217	42	03369	27	03807	38	03900	44	04340 vz	77	05171	153
02226	89	02755	90	03217/S	42	03370	27	03808	38	03901	44	04347 vz	76	05172	153
02227	89	02763	91	03218	42	03372	27	03809	38	03902	44	04351 vz	76	05173	153
02228	89	02770	128	03218/S	42	03373	27	03810	38	03903	44	04356 vz	76	05174	153
02229	89	02774	128	03219	42	03410	37	03815	45	03904	44	04358 vz	76	05175	153
02250	64	02776	128	0											



## Numerical Index

Part-No.	page	Part-No.	page	Part-No.	page	Part-No.	page	Part-No.	page	Part-No.	page	Part-No.	page	Part-No.	page
05208	143	05626	119	10090	25	10243	57	10496	73	10846	33	11995	86	12291	116
05209	143	05626/1	119	10091	25	10244	57	10497	73	10850	38	11996	86	12292	116
05210	143	05626/2	119	10092	25	10250	57	10498	73	10852	38	11997	86	12294	116
05211	143	05627	119	10093	25	10251	57	10499	73	10853	38	11998	86	12295	116
05212	143	05627/1	119	10095	25	10252	57	10500	73	10854	38	11999	86	12296	116
05213	143	05627/2	119	10097	25	10253	57	10526	91	10855	38	12002	86	12297	116
05214	143	05628	119	10118	28	10254	57	10527	91	10856	38	12004	86	12298	116
05215	143	05628/1	119	10120	28	10255	57	10528	91	10857	38	12010	86	12299	116
05216	143	05628/2	119	10125	28	10256	57	10529	91	10858	38	12011	86	12300	116
05217	143	05629	119	10129	30	10257	57	10531	91	10859	38	12012	86	12302	116
05218	143	05629/1	119	10130	30	10258	57	10532	91	10861	38	12013	86	12303	110
05219	143	05629/2	119	10132	30	10259	57	10533	91	10862	38	12105	111	12304	110
05222	137	06100	94	10133	30	10260	57	10535	90	10863	38	12111	203	12305	110
05224	137	06102	94	10134	30	10300	50	10536	90	10864	38	12112	203	12306	110
05226	137	06103	94	10135	30	10300 bl	50	10537	90	10866	38	12113	203	12307	110
05228	137	06105	94	10136	30	10302	50	10538	90	10867	38	12114	203	12308	110
05229	137	06106	94	10137	30	10302 bl	50	10539	90	10868	38	12115	203	12309	110
05253	194	06109	94	10138	31	10304	50	10541	90	10869	38	12116	203	12314	110
05254	194	06110	94	10139	31	10304 bl	50	10544	91	10871	38	12117	203	12315	110
05256	199	06111	94	10140	30	10306	50	10545	89	10872	38	12135	208	12316	110
05258	195	06112	94	10141	31	10306 bl	50	10546	89	10873	38	12136	208	12317	110
05259	195	06113	94	10143	31	10308	50	10547	89	10874	38	12137	208	12322	110
05260	195	06114	94	10144	31	10308 bl	50	10548	89	10875	38	12138	208	12324	203
05262	195	06114/8	94	10145	31	10310	50	10549	89	10876	38	12139	208	12325	203
05265	196	06115	94	10145	43	10310 bl	50	10550	89	10877	38	12140	208	12326	203
05266	197	06116	94	10146	31	10312	50	10551	89	10878	38	12141	208	12327	203
05267	196	06117	94	10147	31	10312 bl	50	10552	89	10880	38	12142	208	12328	203
05267	197	06120	94	10148	31	10314	50	10555	91	10881	38	12143	208	12329	203
05268	196	06121	94	10149	31	10314 bl	50	10556	91	10882	38	12144	208	12330	203
05268	197	06122	94	10149	43	10316	50	10557	91	10905	63	12145	208	12331	203
05269	196	06125	94	10150	31	10316 bl	50	10558	91	10906	63	12149	208	12341	169
05269	197	06126	94	10150	43	10318	50	10560	91	10907	63	12150	202	12342	169
05270	195	06129	94	10151	31	10318 bl	50	10561	91	10910	63	12151	202	12343	169
05272	195	06130	94	10151	43	10320	51	10562	91	10911	63	12152	202	12344	169
05274	195	06131	94	10152	31	10320 bl	51	10565	89	10912	63	12153	202	12345	169
05275	195	06135	93	10152	43	10345	100	10566	89	10915	63	12154	202	12346	169
05276	198	06138	93	10153	31	10346	100	10568	89	10916	63	12155	202	12347	169
05277	198	06139	93	10153	43	10347	100	10569	89	10917	63	12192	170	12348	169
05278	198	06140	93	10154	31	10348	100	10571	89	10920	63	12193	170	12349	169
05279	198	06143	93	10154	43	10350	100	10572	89	10921	63	12194	170	12350	169
05280	198	06144	93	10155	31	10351	100	10585	103	10922	63	12195	170	12351	169
05286	198	06147	93	10155	43	10352	100	10585/6	103	10925	63	12196	170	12352	170
05300	145	06148	93	10156	30	10353	100	10585/7.3	103	10926	63	12197	170	12353	170
05301	145	06149	93	10158	30	10356	100	10586	103	10930	63	12198	170	12354	170
05320	146	06150	93	10159	30	10357	100	10586/13	103	10931	63	12199	170	12355	170
05321	146	06151	93	10160	30	10400	32	10587	103	10932	63	12200	170	12356	170
05322	146	06152	93	10162	30	10400	45	10587/14	103	10936	63	12224	157	12357	170
05400	132	06153	93	10163	30	10402	32	10595	103	10937	63	12225	157	12358	170
05402	133	06156	93	10164	30	10402	45	10595/6	103	10938	63	12226	157	12359	170
05403	133	06157	93	10165	30	10404	32	10595/7.3	103	10940	63	12230	156	12360	170
05404	136	06158	93	10166	31	10404	45	10596	103	10941	63	12231	156	12361	170
05405	136	06161	93	10167	31	10406	32	10596/13	103	10942	63	12232	156	12362	170
05406	136	06162	93	10168	31	10406	45	10597	103	10943	63	12233	156	12363	170
05407	136	06165	93	10169	31	10408	32	10597/14	103	10945	63	12235	157	12364	170
05408	132	06166	93	10170	31	10408	45	10600	103	10946	63	12235/A	157	12365	170
05412	132	06167	93	10171	31	10410	32	10601	103	10947	63	12236	157	12366	170
05419	132	06170	93	10172	31	10410	45	10685	103	10948	63	12236/A	157	12367	170
05460	115	06171	93	10173	31	10412	32	10685/6	103	11000	21	12237	157	12368	170
05490	117	06174	93	10174	31	10412	45	10685/7.3	103	11001	21	12238	157	12369	170
05491	117	06175	93	10174	43	10414	32	10686	103	11004	21	12239	157	12370	162
05492	117	06176	93	10175	31	10414	45	10686/13	103	11005	21	12240	157	12370/50	162
05493	117	06178	93	10175	43	10416	32	10687	103	11008	21	12241	157	12371	162
05494	117	06179	93	10176	31	10416	45	10687/14	103	11009	21	12242	157	12372	161
05495	117	06182	93	10176	43	10418	32	10695	103	11020	20	12243	157	12372/50	161
05500	116	06183	93	10177	31	10418	45	10695/6	103	11021	20	12244	157	12373	161
05501	116	06184	93	10177	43	10420	32	10695/7.3	103	11022	20	12245	157	12374	162
05502	116	06185	93	10178	31	10420	45	10696	103	11025	122	12246	157	12375	161
05503	116	06186	93	10178	43	10422	32	10696/13	103	11026	122	12247	157	12376	161
05504	116	06187	93	10190	31	10422	45	10697	103	11027	122	12248	157	12377	161
05505	116	10005	20	10190	43	10424	32	10697/14	103	11028	122	12249	157	12378	170
05530	117	10015	20	10210	51	10424	45	10700	36	11029	122	12249/A	157	12379	170
05531	117	10021.01.02	15	10210 vz	51	10426	32	10700/S	36	11030	122	12250	157	12380	170
05532	117	10022.01	17	10211	51	10426	45	10702	36	11031	122	12250/A	157	12381	170
05533	117	10024.01	17	10211 vz	51	10428	32	10702/S	36	11032	122	12251	157	12382	170
05534	117	10025	122	10212	51	10428	45	10704	36	11033	122	12252	157	12383	170
05535	117	10026	122	10212 vz	51	10430	32	10704/S	36	11034	122	12252/A	157	12384	170
05540	117	10027	122	10212/35	51	10432	32	10706	36	11040	20	12253	157	12385	170
05541	117	10028	122	10212/35 vz	51	10434	32	10706/S	36	11041	20	12253/A	157	12386	170
05542	117	10029	122	10213	51	10436	32	10707	36	11042	20	12258	157	12390	168
05543	117	10030	122	10213 vz	51	10438	32	10707/S	36	11100	135	12258/A	157	12391	168
05544	117	10031	122	10213/35	51	10438/S-45	33	10708	36	11101	135	12259	157	12392	168
05545	117	10032	122	10213/35 vz	51	10440	32	10708/S	36	11102	135	12259/A	157	12393	168
05550	116	10033	122	10214	51	10441	32	10710	36	11103	135	12265	157	1	

## Numerical Index

Part-No.	page	Part-No.	page	Part-No.	page	Part-No.	page	Part-No.	page	Part-No.	page	Part-No.	page
12447	159	12588	204	12748	138	12950	203	13136	52	13258	62	13553	138
12456	166	12590	204	12748	179	12951	203	13136 bl	52	13259	62	13553	139
12457	166	12591/Cu	204	12749	138	12952	203	13138	52	13260	62	13553	177
12458	166	12591/Va	204	12749	179	12955	203	13138 bl	52	13261	62	13553	179
12460	166	12600/N	152	12751	138	12956	203	13140	52	13262	62	13553	181
12461	166	12601	152	12751	179	12957	203	13140 bl	52	13262/8	62	13553	183
12462	166	12602	152	12753	179	12958	203	13142	52	13263	62	13553	184
12468	166	12603	134	12762	168	12959	203	13142 bl	52	13264	62	13553	185
12469	166	12604	134	12763	168	12960	203	13143	52	13264/8	62	13554	138
12470	166	12607	134	12764	168	12961	203	13143 bl	52	13265	62	13554	139
12471	166	12608	134	12765	168	12962	203	13144	52	13266	62	13554	177
12472	166	12609	134	12766	172	12965/S	173	13144 bl	52	13267	62	13554	179
12473	166	12610	132	12767	172	12966	173	13146	52	13268	62	13554	181
12475	167	12614	134	12784	187	12968	173	13146 bl	52	13269	62	13554	183
12476	167	12615	155	12785	187	12969	173	13148	52	13270	62	13554	184
12477	167	12616	155	12786	187	12972	202	13148 bl	52	13271	62	13554	185
12478	167	12617	155	12787	187	12975	204	13150	52	13272	62	13555	138
12479	167	12618	155	12788	187	12976	204	13150 bl	52	13273	62	13555	139
12480	194	12619	155	12789	187	12977	204	13152	52	13274	62	13555	177
12485	199	12620	155	12790	187	12978	204	13152 bl	52	13274/8	62	13555	179
12486	199	12622 N	142	12792	187	12979	204	13154	52	13275	62	13555	181
12487	199	12623 N	142	12793	187	12980	207	13154 bl	52	13275/15	62	13555	183
12491	199	12626	134	12794	187	12981	207	13156	52	13276	62	13555	184
12492	203	12627	134	12795	187	12982	207	13156 bl	52	13276/15	62	13555	185
12493	203	12633	142	12796	187	12983	207	13157	52	13277	62	13600	66
12494	203	12637	148	12797	187	12984	207	13157 bl	52	13277/15	62	13601	66
12495	203	12640	149	12798	187	12985	207	13158	52	13278	62	13602	66
12496	203	12641	149	12799	187	12986	207	13158 bl	52	13279	62	13603	66
12497	203	12642 N	142	12800	169	12987	207	13160	52	13285	50	13604	66
12498	203	12645/N	158	12801	169	12988	207	13160 bl	52	13285 bl	50	13605	66
12499	203	12646	149	12802	169	12989	207	13162	52	13286	50	13607	66
12499/240f	203	12647	149	12803	169	12990	207	13162 bl	52	13286 bl	50	13608	66
12503	202	12648	150	12804	169	12991	207	13163	52	13287	50	13609	66
12504	202	12649	150	12805	169	12992	207	13163 bl	52	13287 bl	50	13610	66
12505	202	12650	162	12806	169	12992/300	207	13164	52	13288	50	13611	66
12506	202	12651	164	12807	169	12993	207	13164 bl	52	13288 bl	50	13612	66
12507	202	12652	166	12809	170	12994	207	13166	52	13295	60	13613	66
12508/Cu	202	12653	166	12810	170	12995	207	13166 bl	52	13296	60	13614	66
12508/Va	202	12654	166	12811	170	12996	207	13168	52	13297	60	13615	66
12510	150	12655	165	12812	170	12997	207	13168 bl	52	13332	101	13616	66
12512	150	12656	165	12813	170	12998	207	13170	52	13333	101	13617	67
12514	150	12657	165	12814	170	12999	207	13170 bl	52	13336	101	13618	67
12515	168	12658	165	12815	170	13048	206	13172	52	13337	101	13619	67
12516	168	12659	165	12816	170	13049	206	13172 bl	52	13345	100	13620	67
12517	168	12660	165	12817	170	13050	206	13174	52	13346	100	13621	67
12518	168	12661	165	12818	170	13051	206	13174 bl	52	13347	100	13622	67
12519	168	12662	165	12832	140	13052	206	13176	52	13348	100	13623	67
12520	209	12665	165	12832	201	13053	206	13176 bl	52	13349	100	13624	67
12521	209	12666	165	12833	140	13054	206	13177	52	13350	100	13625	67
12522	209	12667	165	12833	201	13055	206	13177 bl	52	13351	100	13626	67
12523	209	12668	165	12834	140	13056	206	13178	52	13352	100	13627	67
12524	209	12669	165	12834	201	13057	206	13178 bl	52	13353	101	13628	67
12525	209	12670	165	12835	140	13058	206	13180	52	13354	101	13629	67
12526	209	12671	166	12835	201	13059	206	13180 bl	52	13355	101	13630	67
12527	209	12672	166	12836	192	13060	125	13182	52	13356	101	13631	67
12528	209	12673	166	12837	200	13061	125	13182 bl	52	13414	62	13632	67
12529	209	12674	166	12843	144	13062	125	13184	52	13415	62	13633	67
12533	209	12675	166	12844	144	13063	125	13184 bl	52	13416	62	13634	67
12534	209	12676	166	12845	144	13064	125	13186	52	13417	62	13635	67
12535	209	12677	166	12846	144	13066	125	13186 bl	52	13418	62	13636	67
12536	209	12678	166	12855/N	154	13068	125	13188	52	13419	62	13637	67
12538	209	12679	166	12858	153	13069	125	13188 bl	52	13435	85	13638	67
12539	209	12680	167	12869	162	13080 S	92	13190	52	13436	85	13639	67
12540	209	12681	167	12888	170	13081 S	92	13190 bl	52	13437	85	13640	67
12540/Al	209	12682	167	12889	170	13082 S	92	13192	52	13438	85	13650	36
12541	209	12683	167	12890	170	13083 S	92	13192 bl	52	13439	85	13650/S	36
12542	209	12685	167	12891	170	13084 S	92	13194	52	13440	85	13651	36
12543	209	12686	167	12892	170	13085 S	92	13194 bl	52	13485	205	13651/S	36
12544	209	12687	167	12893	170	13095	127	13195	52	13486	205	13652	36
12545	209	12688	167	12907	207	13096	127	13195 bl	52	13487	205	13652/S	36
12546	209	12689	167	12908	209	13097	127	13196	52	13488	205	13653	36
12548	187	12690	168	12909	209	13098	127	13196 bl	52	13489	205	13653/S	36
12549	187	12691	168	12910	209	13099	127	13197	52	13490	205	13654	36
12550	187	12692	168	12911	209	13100	127	13197 bl	52	13491	205	13654/S	36
12551	187	12693	168	12912	209	13101	127	13198	52	13492	205	13655	36
12554	187	12694	168	12913	209	13102	127	13198 bl	52	13493	205	13655/S	36
12555	187	12695	168	12914	209	13103	127	13199	66	13494	205	13656	36
12556	187	12696	168	12915	209	13104	127	13200	66	13495	205	13656/S	36
12557	187	12697	168	12916	209	13105	127	13201	66	13534	139	13657	36
12558	187	12698	168	12917	209	13106	127	13202	66	13534	184	13657/S	36
12559	187	12721	192	12918	209	13107	127	13203	66	13535	139	13658	36
12560	187	12724	191	12918/Al	209	13108	127	13204	66	13535	185	13658/S	36
12561	187	12725	186	12918/UL	208	13109	127	13205	66	13537	183	13659	36
12562	169	12726	186	12919	209	13110	127	13206	66	13538	138	13659/S	36
12563	169	12726	189	12919/UL	208	13111	127	13207	66	13538	139	13660	36
12564	169	12726	191	12920	209	13112	127	13208	66	13538	177	13660/S	36
12565	169	12726	192	12920/UL	208	13113	127	13209	66	13538	179	13661	36
12566	169	12726/3,0	196	12921	209	13114	127	13228	120	13538	181	13661/S	36
12567	169	12726/3,0	197	12923	202	13115	127	13229	120	13538	183	13662	36
12568	169	12727	186	12924	202	13116	127	13230	120	13538	184	13662/S	36
12569	169	12727	189	12925	202	13117	127	13230/s	120	13538	185	13663	36
12570	169	12727	191	12926	202	13118	127	13231	120	13540	207	13663/S	36
12571	169	12727	192	12927	202	13119	127	13231/s	120	13541	207	13664	36
12572	169	12727	196	12928	202	13124	52	13232					

## Numerical Index

Part-No.	page	Part-No.	page	Part-No.	page	Part-No.	page	Part-No.	page	Part-No.	page	Part-No.	page
13994	205	15280/B2	104	23837	96	24096	106	24323	107	30063	123	40070	56
13995	205	15281/A1	104	23838	96	24097	106	24324	107	30064	123	40100	58
13996	205	15281/A2	104	23839	96	24098	106	24325	107	30065	123	40101	58
13997	205	15281/B1	104	23840	96	24105	110	24326	107	30066	123	40102	58
13998	205	15281/B2	104	23841	96	24106	110	24327	107	30067	123	40106	58
13999	205	15282/A1	104	23842	96	24107	110	24328	107	30068	123	40107	58
14120	206	15282/A2	104	23843	96	24108	110	24330	107	30069	123	40108	58
14121	206	15282/B1	104	23844	96	24110	110	24331	107	30070	123	40112	58
14122	206	15282/B2	104	23845	96	24111	110	24332	107	30072	123	40113	58
14123	206	15283/A1	104	23850	97	24112	111	24333	107	30080	123	40114	58
14124	206	15283/A2	104	23851	97	24113	111	24334	107	30081	123	40115	58
14125	206	15283/B1	104	23852	97	24114	111	24335	107	30082	123	40119	58
14126	206	15283/B2	104	23853	97	24117	111	24336	107	30083	123	40120	58
14127	206	15284/A1	104	23854	97	24118	111	24337	107	30084	123	40121	58
14128	206	15284/A2	104	23855	97	24119	111	24338	107	30085	123	40122	58
14129	206	15284/B1	104	23856	97	24120	111	24340	107	30086	123	40126	58
14130	206	15284/B2	104	23857	97	24121	111	24341	107	30087	123	40127	58
14131	206	15285/A1	104	23858	97	24122	111	24342	107	30088	123	40128	58
14132	206	15285/A2	104	23859	97	24123	111	24344	107	30089	123	40129	58
14133	206	15285/B1	104	23870	97	24124	111	24345	107	30090	123	40134	58
14140	205	15285/B2	104	23871	97	24125	111	24346	107	30091	123	40135	58
14141	205	15286/A1	104	23872	97	24126	111	24347	107	30092	123	40136	58
14142	205	15286/A2	104	23873	97	24127	111	24350	108	30093	123	40142	58
14143	205	15286/B1	104	23874	97	24135	112	24351	108	30100	124	40143	58
14144	205	15286/B2	104	23875	97	24136	112	24352	108	30101	124	40149	58
14145	205	15287/A1	104	23876	97	24137	112	24353	108	30102	124	40150	58
14146	205	15287/A2	104	23877	97	24150	112	24355	108	30103	124	40151	58
14147	205	15287/B1	104	23878	97	24151	112	24356	108	30104	124	40155	58
14148	205	15287/B2	104	23879	97	24155	112	24358	108	30105	124	40156	58
14149	205	15288/A1	104	23890	98	24156	112	24359	108	30106	124	40157	58
14150	205	15288/A2	104	23891	98	24165	110	24360	109	30107	124	40158	58
14151	205	15288/B1	104	23892	98	24167	110	24361	109	30108	124	40162	58
14152	207	15288/B2	104	23893	98	24168	110	24362	109	30109	124	40163	58
14153	207	15289/A1	104	23894	98	24169	110	24363	109	30110	124	40164	58
14154	207	15289/A2	104	23895	98	24170	110	24364	109	30111	124	40165	58
14155	207	15289/B1	104	23896	98	24172	113	24365	109	30112	124	40169	58
14156	207	15289/B2	104	23897	98	24173	113	24366	109	30113	124	40170	58
14157	207	15290/A1	104	23898	98	24175	113	24367	109	30122	125	40171	58
14158	207	15290/A2	104	23899	98	24176	113	24370	109	30128	125	40201	59
14159	207	15290/B1	104	23900	98	24176/1	113	24371	109	30129	125	40202	59
14163	206	15290/B2	104	23901	98	24177	113	24372	109	30182	124	40203	59
14164	206	15803	125	23902	98	24178	113	24373	109	30183	124	40204	59
14165	206	15804	125	23903	98	24179	113	24374	109	30184	124	40208	59
14166/Cu	206	15806	125	23904	98	24211	106	24375	109	30185	124	40209	59
14166/Va	206	15808	125	23905	98	24212	106	24376	109	30186	124	40210	59
14167/Cu	206	15809	125	23906	98	24213	106	24377	109	30187	124	40211	59
14167/Va	206	15821	125	23907	98	24214	106	24400	110	30188	124	40215	59
14168/Cu	206	15823	125	23908	98	24215	106	24401	110	30189	124	40216	59
14168/Va	206	15824	125	23909	98	24216	106	24402	110	30190	124	40217	59
14169/Cu	206	15825	125	23910	98	24220	106	24403	110	30191	124	40218	59
14169/Va	206	15826	125	24000	106	24221	106	24404	110	30192	124	40222	59
14170	206	15828	125	24001	106	24222	106	24405	110	30193	124	40223	59
14171	206	15829	125	24001/1	106	24223	106	24406	110	30195	126	40224	59
14172	206	15890	127	24002	106	24224	106	24407	110	30196	126	40228	59
14173	206	15891	127	24003	106	24225	106	24408	110	30197	126	40229	59
14174	206	15892	127	24004	106	24230	106	24409	110	30198	126	40230	59
14175	206	15893	127	24008	106	24231	106	24410	110	30199	126	40231	59
14176	206	15894	127	24009	106	24232	106	24411	110	30200	126	40235	59
14177	206	15895	127	24009/1	106	24233	106	24415	110	30201	126	40236	59
14178	208	15896	127	24010	106	24234	106	24420	113	30445	160	40237	59
14179	208	15897	127	24011	106	24235	106	24421	113	30446	160	40241	59
14180	208	15898	127	24012	106	24240	106	24422	113	30460	167	40242	59
14181	208	16320	98	24016	106	24241	106	24425	113	30470	167	40243	59
14182	208	16325	98	24017	106	24242	106	24426	113	30475	155	40244	59
14183	208	16330	98	24017/1	106	24243	106	30001	18	30477	155	40248	59
14184	208	16331	98	24018	106	24244	106	30002	18	30480	155	40249	59
14185	208	16335	98	24019	106	24245	106	30003	19	30481	155	40250	59
14240	138	16336	98	24020	106	24250	106	30010	19	31460	169	40251	59
14240	177	16340	98	24024	106	24251	106	30011	19	31465	169	40255	59
14241	177	16345	98	24025	106	24252	106	30012	19	40010	56	40256	59
14242	177	16350	98	24025/1	106	24253	106	30013	19	40011	56	40257	59
14243	138	16351	98	24026	106	24260	106	30014	19	40014	56	40258	59
14243	177	16355	98	24027	106	24261	106	30018	19	40015	56	40259	59
14244	138	16356	98	24028	106	24262	106	30020	19	40016	56	40261	59
14244	177	16360	98	24053	109	24263	106	30022	19	40019	56	40262	59
14245	138	16365	98	24054	109	24270	106	30024	18	40020	56	40263	59
14245	177	16370	98	24055	109	24271	106	30025	18	40021	56	40264	59
14250	208	16375	98	24056	109	24272	106	30026	18	40024	56	40265	59
14251	208	16380	98	24058	108	24273	106	30028	18	40025	56	54140	126
14252	208	16385	98	24059	108	24280	106	30029	18	40026	56	54142	126
14253	208	16390	98	24060	108	24281	106	30039	120	40029	56	54144	126
14254	208	16395	98	24065	111	24282	106	30039/s	120	40030	56	54146	126
14255	208	23810	96	24066	111	24283	106	30042	120	40031	56	54148	126
14256	208	23811	96	24067	111	24301	107	30042/s	120	40034	56	54150	126
14257	208	23812	96	24070	106	24302	107	30043	120	40035	56	54154	126
14258	208	23813	96	24071	106	24303	107	30043/s	120	40036	56	54158	126
14259	208	23814	96	24071/1	106	24304	107	30044	120	40039	56	54162	126
14260	208	23815	96	24072	106	24305	107	30044/s	120	40040	56	54164	126
14261	208	23816	96	24073	106	24306	107	30045	120	40041	56	54166	126
15014	40	23817	96	24074	106	24307	107	30045/s	120	40044	56	54172	126
15016	40	23818	96	24078	106	24308	107	30049	120	40045	56	54176	126
15020	40	23819	96	24079	106	24309	107	30049/s	120	40046	56	54178	126
15022	40	23820	96	24079/1	106	24310	107	30050	120	40049	56	54182	126
15024	40	23821	96	24080</									



## Numerical Index

Part-No.	page	Part-No.	page	Part-No.	page	Part-No.	page	Part-No.	page	Part-No.	page	Part-No.	page
56067	68												
56068	68												
56069	68												
56070	68												
56070/1	68												
56071	68												
56072	68												
56072/1	68												
56073	68												
56074	68												
56075	68												
56076	68												
56077	68												
56078	68												
56079	68												
56080	69												
56081	69												
56081 str	69												
56082	69												
56083	69												
56084	69												
56085	69												
56086	69												
56087	69												
56088	69												
56089	69												
56090	69												
56090/1	69												
56091	69												
57000	70												
57001	70												
57002	70												
57003	70												
57004	70												
57005	70												
57006	70												
57007	70												
57008	70												
57009	70												
57010	70												
57011	70												
57012	70												
58000	70												
58002	70												
58004	70												
58006	70												
58008	70												
58010	70												
58012	70												
58014	70												









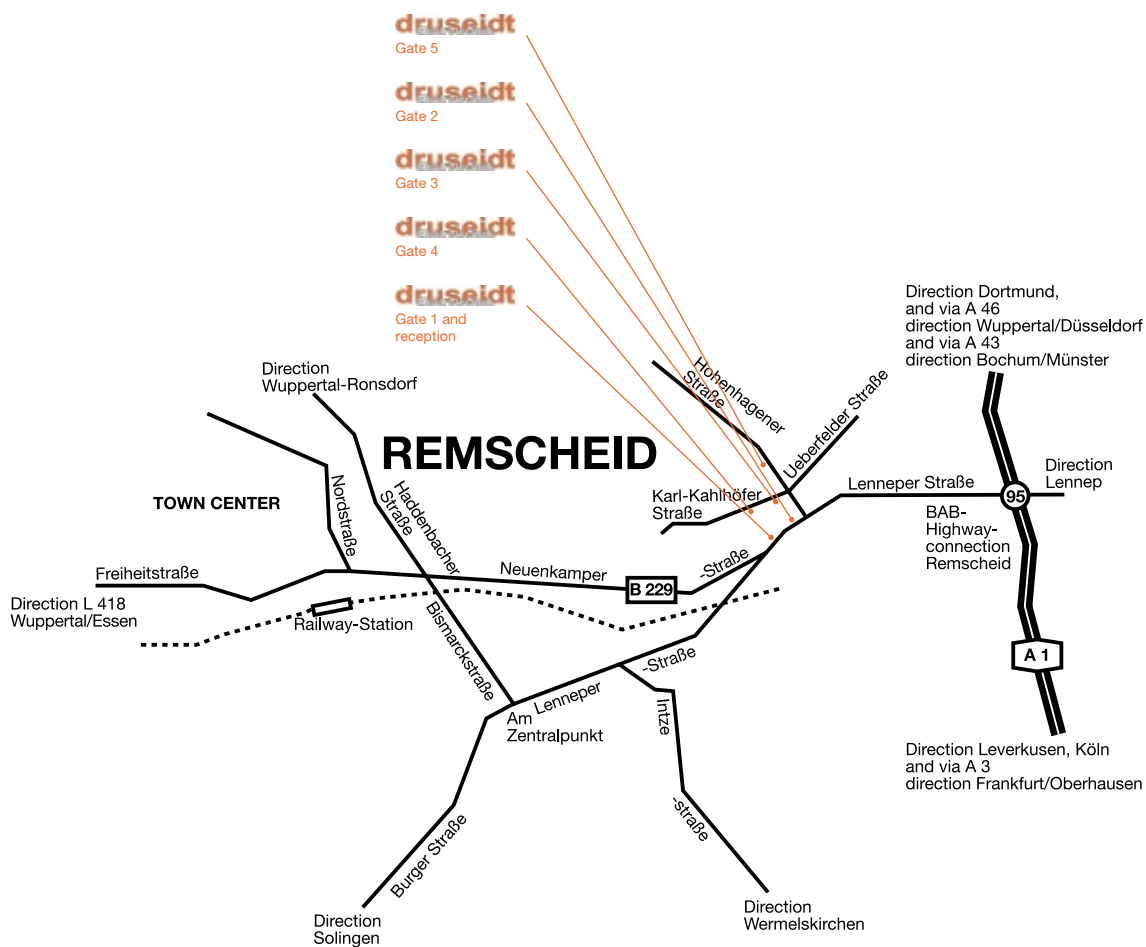

Paul Druseidt  
Elektrotechnische Spezialfabrik GmbH & Co. KG

P.O. Box: 10 02 25  
42802 Remscheid  
Germany

Gate 1: Neuenkamper Straße 105  
Gate 2: Lenneper Straße 131  
Gate 3: Karl-Kahlhöfer-Straße 9  
Gate 4: Karl-Kahlhöfer-Straße 11  
Gate 5: Hohenhagener Straße 15

42855 Remscheid  
Germany

Phone: +49 (21 91) 93 52-0  
Fax: +49 (21 91) 93 52-150  
http: www.druseidt.de  
E-Mail: info@druseidt.de

**Please order also our detailed catalogues to the following subjects:**

Flexible air and watercooled connectors and cables for Hi-Tech-applications  
Main catalogue for contact systems and accessories for electroplating and anodizing equipments