

Planning and technical information

Information we need	E03
Assembly requirements	E04-E06
Fire protection	E07
Cable assignment	E08-E10
Impact noise behaviour	E11-E13
Casing depth device cup including installation device	E14-E15
Types of protection and floor maintenance of installation units	E16-E17
Data technology	E18-E21

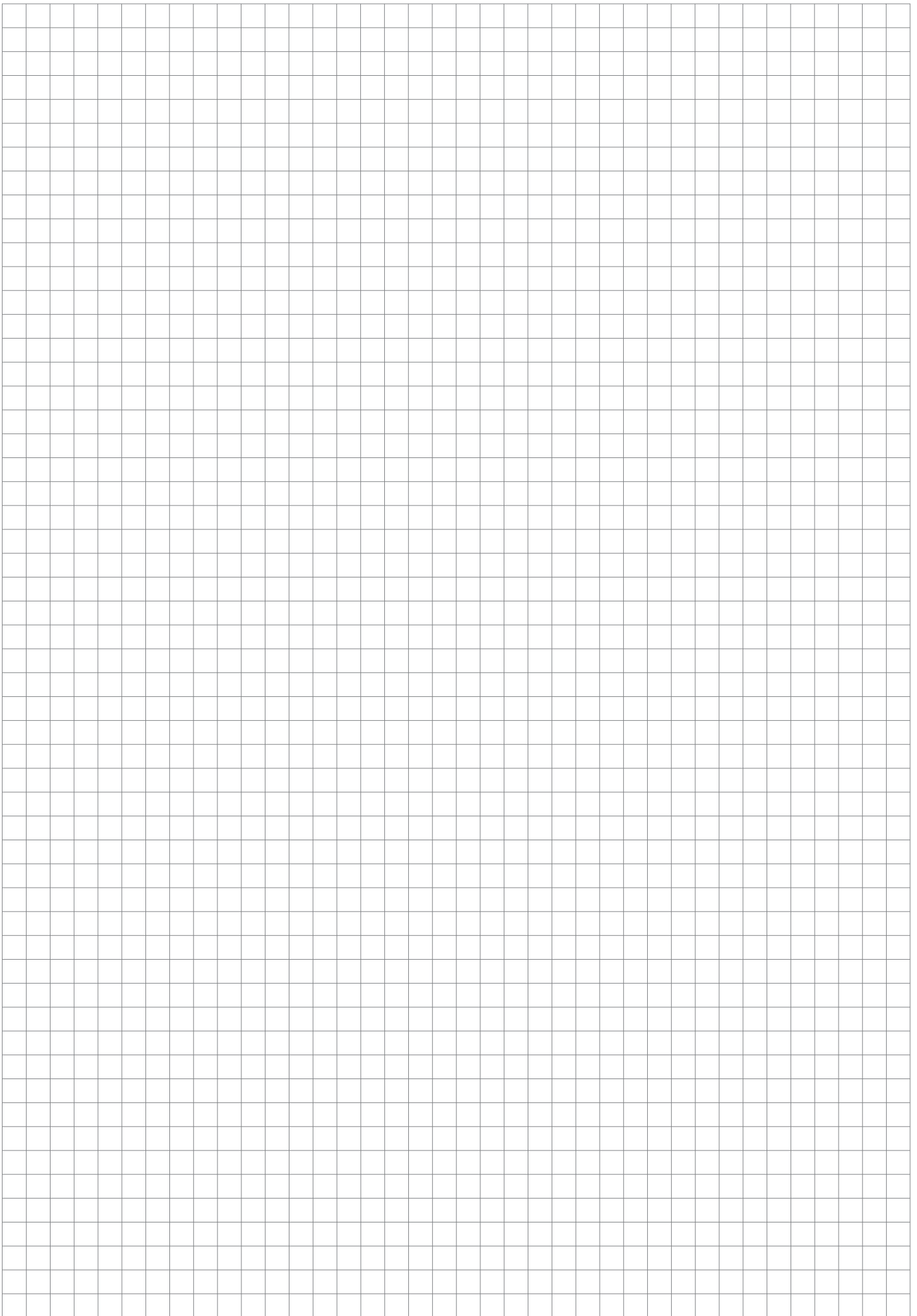



Information we need

Technical information

1. Which floor system should be / is used?

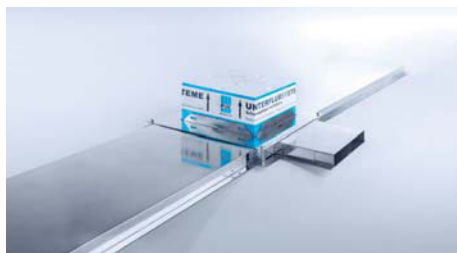

- screed flush
- screed-covered
- false or hollow space floor

3. Types of screed



- screed
- hot asphalt

5. Flooring

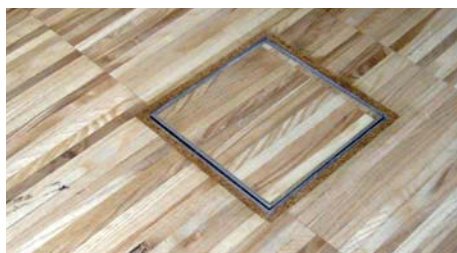

- carpet
- linoleum
- parquet
- stone
- asphalt
- other: _____

7. Form of mounting unit



- round
- quadrangular

9. Assembly



number of high-voltage installation units:
_____ pc

number of data technology installation units:
_____ pc

2. Floor construction

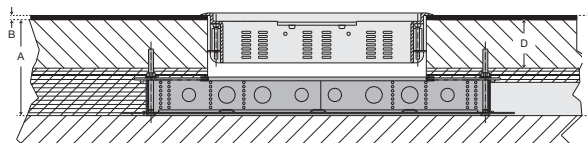

A) height from concrete to screed top edge _____ mm
 B) floor covering thickness _____ mm
 C) total floor construction _____ mm
 D) screed thickness _____ mm

4. Resilience of the system



- office loads
- heavy loads

6. Cleaning of flooring



- dry maintained rooms
- wet maintained rooms

8. Material



- stainless steel
- plastic

10. Version



- German Schuko plug-system
- British plug-system
- French plug-system



E

Assembly requirements

Technical information

Structural requirements

In order to be able to start installing an underfloor duct system, the following requirements must be fulfilled and on hand:

- approved dimensioned installation plan, specifying the location of all assembly parts
- project piece list with the materials to be installed
- documents providing information on floor construction and floor covers
- an approved, clean and swept shell ceiling in the constructional tolerances based on DIN 18 202 (see appendix 2)
- the precise cutting check as a reference point for the corresponding screed height
- specifications regarding traffic loads, fire preventions and subsonic noise behaviour
- the mounting area must be free of construction waste and extraneous material
- protection against weather conditions and moisture must be guaranteed
- specifications regarding minimum installation depth and floor maintenance of installation units

Screed work

Ducts and accessory parts are construction parts that reach their complete loading capacity for the intended use only in firm combination with screed.

In detail the following requirements are indispensable for this purpose:

- The duct system must be sealed before applying the screed
- The system elements must be firmly fixed to the slab ceiling
- The mounted duct system must not be walked upon or strained in any other way
- A safe composite of the duct system and screed must be guaranteed
- Occurring hollow spaces must be lined with screed
- A good thickness and concision of screed must be guaranteed in the floor box areas and in the area of the screed flush duct, in order to prevent later irregularities and cracks in screed
- The duct system must be strained only after the hardening of the screed. Until then, access to the area must be denied
- Screed deformations and shrinkage must be observed

beforehand

The use of insulating strips for the decoupling of the duct system from the screed may lead to a damage of the screed, respectively duct, and to fissuring of the floor cover and must therefore be refrained from.

Expansion joints between the screed and the screed flush ducts can consequently result in deformations of the duct and impair the stability and load capacity of the entire system.

Complying to of the screed types and minimum screed thickness according to DIN 18 560-2 (see appendix 1) must be guaranteed. Thereby a nominal screed thickness of at least 40 mm above the duct for office and work space with a distributed load of up to 2 kN/m² must be observed.

Higher loads require correspondingly higher nominal screed thicknesses based on DIN EN 18560. The duct system itself will be strained with a single load of 750 N/cm² and inspected with accordance to the norm.

When using liquid screed, all openings of < 7 mm conforming to standards must be professionally masked.

Hot asphalt

When using hot asphalt, please note:

- The duct system must be protected from high installation temperatures by using suitable insulation layers
- If the insulation layers are > 2 mm, the insulation strip between the shuttering unit and asphalt must be removed after the hot asphalt has cooled off and the formed gap must be filled with suitable materials flush with the surface
- The shuttering unit must be removed after the hardening of the material

Assembly requirements

Technical information

The use of the duct system

The underfloor system must comply with the requirements of DIN EN 50085. The duct system must be mounted on the slab ceiling according to the mounting instructions and taking into account the technical information.

When using a hollow space floor box with a shuttering unit, the following aspects must be complied to:

- The components must be protected against moisture and mechanical damage
- solid and vertical pre-assembly in the floor box
- spray with formwork oil before applying screed
- To decouple floor box and screed, only separating foil of < 2 mm thickness may be used
- apply screed precisely

The floor boxes must have the following minimum screed height in order to be applicable:

Article-Number	Duct Height	Minimum height	Use
UBDHB350/250 28	28 mm	65 mm	pultrusion cup
UBDHB350/250 38	38 mm	75 mm	pultrusion/installation cup
UBDHB350/250 48	48 mm	85 mm	pultrusion/installation cup

The screed flush duct system requires a minimum floor construction of 60 mm.

Including the duct system into protection measures

- All metallic parts of the entire duct system must be included in the protection measures
- According to VDE all conductive parts of the duct system must be included in the potential equalization. This is done at the transition points of the installation parts by welding, riveting, creating a firm pressure connection using bolted joints or by means of flexible earthing conductors
- The electric installation duct system may not be used as an equipotential bonding conductor
- The duct system must be connected to in the potential equalization of the entire system in the context of the electrical installation work

- When using light plastic-sheathed cable with protective insulation, it is sufficient to include only the floor boxes into the safety measures. For this purpose, each floor box body is equipped with a conductor clamp.
- In case of expansion gaps it must be ensured that the connections between the installation parts are performed in a flexible manner.

The declared linear impedance for electrical installation duct lengths UK is 0.001 ohm per metre and for the screed flush duct systems UEBS 0.0005 ohm per metre.

Floor covers

When selecting floor cover materials please mind that the underfloor installation systems are subject to the impact of payloads and are classified by means of test loads of 500 N to 15.000 N according to DIN EN 500 85. Thereby dynamic deflections of up to 6 mm and lasting distortions of up to 3 mm are not objectionable.

Flatness measures for full-area floors must be observed in accordance with DIN 18202 Table 3, line 3.

Self-supporting layer thickness for exposed concrete floor covers, synthetic resin covers, melted asphalt covers as well as tiles or dressed stone therefore prevent later fissuring of the cover with changing dynamic pressure.

Already minor deflections cause damage of thin, hard floor covers such as tiles. Solid floor covers such as granite slabs increase the load capacity of the underfloor installation system and allow for a better load spreading.



Appendix 1: Excerpt from DIN 18560-2:2009-09

Table 1 – Nominal thicknesses and bending tensile strength or hardness of unheated screed on insulation layers for vertical loading capacities $\leq 2 \text{ kN/m}^2$

Screed type	Bending stress class / hardness class according to DIN EN 13813	Nominal screed thickness ^a [mm] with a compressibility of the insulation layer ^c $\leq 5 \text{ mm}^b$	Confirmatory test Bending tensile strength βBZ [N/mm ²]		Depth of penetration [mm]	
			Lowest single value	Medium value	at (22 ± 1) °C	at (40 ± 1) °C
Calcium sulphate floating screed CAF	F4	≥ 35	≥ 3,5	≥ 4,0	–	–
	F5	≥ 35	≥ 4,5	≥ 5,0	–	–
	F7	≥ 35	≥ 6,5	≥ 7,0	–	–
Calcium sulphate screed CA	F4	≥ 45	≥ 2,0	≥ 2,5	–	–
	F5	≥ 40	≥ 2,5	≥ 3,5	–	–
	F7	≥ 35	≥ 3,5	≥ 4,5	–	–
Melted asphalt screed AS	IC10	≥ 25	–	–	≤ 1,0	≤ 4,0
	ICH10	≥ 35	–	–	≤ 1,0	≤ 2,0
Synthetic resin screed SR	F7	≥ 35	≥ 4,5	≥ 5,5	–	–
	F10	≥ 30	≥ 6,5	≥ 7,0	–	–
Magnesia screed MA	F4 ^c	≥ 45	≥ 2,0	≥ 2,5	–	–
	F5	≥ 40	≥ 2,5	≥ 3,5	–	–
	F7	≥ 35	≥ 3,5	≥ 4,5	–	–
Cement screed CT	F4	≥ 45	≥ 2,0	≥ 2,5	–	–
	F5	≥ 40	≥ 2,5	≥ 3,5	–	–

a For insulation layers of $\leq 40 \text{ mm}$ with calcium sulphate, synthetic resin, magnesia and cement screed, the nominal screed thickness may be reduced by 5 mm. The minimum thickness of 30 mm may not be under cut (except with melted asphalt).

b When using melted asphalt screed, the compressibility of the insulation layers may not be above 3 mm.

c The surface hardness of stone-wood screeds must correspond with at least SH 30 according to DIN EN 13813.

d In case of a higher compressibility ($\leq 10 \text{ mm}$), the nominal screed thickness must be increased by 5 mm.

Appendix 2: Excerpt from DIN 18202

Table 3 – Flatness tolerances

Column	1	2	3	4	5	6
Line	Subject	Depth gauge as critical values in mm for measurement point distances in m up to				
		0,1	1 ¹⁾	4 ¹⁾	10 ¹⁾	15 ¹⁾²⁾
1	Unfinished topsides of ceilings, subconcrete and under-floors	10	15	20	25	30
2	Unfinished topsides of ceilings, subconcrete and under-floor, with higher requirements, e.g. for the installation of floating screed, industrial floors, tiles, flagging and bonded screed. Finished topsides for secondary purposes, e.g. in storage rooms, cellars.	5	8	12	15	20
3	Exposed flooring, e.g. screed as finished screed, screed as a basis for floor covers; floor covers, tiles covers, primed and glued covers	2	4	10	12	15
4	Like line 3, however with higher requirements	1	3	9	12	15
5	Unfinished walls and undersides of slab ceilings	5	10	15	25	30
6	Exposed walls and undersides of slabs, e.g. plastered walls, paneling, suspended ceiling	3	5	10	20	25
7	Like line 6, however with higher requirements	2	3	8	15	20

1) For interim values please see image 1 and 2 and round to whole mm.

2) The flatness tolerances in column 6 are also valid for measure point distances of above 15 m.

„Reprint courtesy of the German Standardisation Institute (DIN Deutsches Institut für Normung e. V.). The version relevant for the application of the DIN standard is its issue with the most recent date, available from the Beuth Verlag GmbH, Burggrafenstraße 6, 10787 Berlin.“

Fire protection for screed-covered underfloor systems

Technical information

General information

The reaction to fire of construction materials and construction parts is specified in DIN 4102-9. (The fire inspections of cable insulations are specified in section 9.)

If fire resistance for a certain wall is required (DIN 4102 does not regulate fire resistances; they are specified in the state construction regulations as well as in other regulations, such as e.g. in the industrial building guideline), ducts may only be fed through that wall if the spreading of a fire may not be feared for a sufficiently time period of time, or if precautions against it have been taken. For the use of electrical installation duct systems this means that, if fire protection walls are crossed, they must be re-sealed providing fire protection and safety from smoke gas.

Wichmann cable fire insulation

By implementing the approved Systems Wichmann WD 90 cable fire insulation, a fire resistance period of 90 minutes will prevent the fire and smoke from being released through installation openings in fire protection walls. In detail the fire stop consists of a box with fire protection packages that in case of a fire will generate foam from 100°C on and of an independent smoke seal by means of EasyFoam plugs. Hereby a proper assembly and handling in accordance with the general construction approval must be complied to.

As a result, the implementation of the fire stop in duct systems offers the operator the following benefits:

- the use of an open separation in the fire protection wall
- a separate smoke gas insulation in the floor box
- an easy assembly and subsequent installation
- the duct system can be installed within the heat- and impact sound insulation

System requirements

- test standard: DIN 4102-9
- fire rating: S90
- approval specifications: Z-19.15-202
- verification of applicability: approval specifications with manufacturer's certificate

After the completed mounting in accordance with the following assembly instructions, a corresponding manufacturer's certificate must be requested, confirming to the constructor that this specific installation based on the building regulation is an „irrelevant deviation“ from the approval specifications. Provided a proper execution, a compliance with the approval specifications would be handed out.

German model duct systems guideline (MLAR)

Based on the regulations of MLAR, the following statement is made regarding fire protection behaviour in section 3.5.6:

„Underfloor ducts for cables that are screed-flush or screed covered must have an upper cover made of inflammable construction materials in necessary stairwells, in spaces between necessary stairwells and in outdoor exits as well as in necessary corridors. They must not have an opening except in the necessary corridors: inspection openings or openings for subsequent cable assignment with tightly closing sealings made of fire-proof materials.“

In this context it must be complied to that hollow floors must have a minimum screed thickness of 30 mm over underfloor duct.



Cable assignment in duct

Technical information

The calculation of the cable volume is the groundwork for the planning process. The cross sections of the selected standard duct types are average values. The calculation is based on a duct filling factor of no more than 60%. Note reduction in the cross-section by the installation depth of device cup and installation unit. For power load see DIN VDE 0100/0298.

Minimum installation cross section for one installation unit

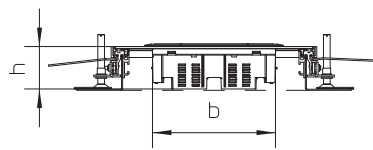

	h mm	b mm	a cm ²
BODO T	100	118	118
UEKD2-R	65	240	156
UEKD2-V	65	184	120
UEKD3-R	65	300	195
UEKD3-V	65	256	166
UEDD V E	70	230	161
UEKDD2 V E	70	155	109
UEKDD1-2 V E	70	130	91

UEBS screed-flush duct with side profile

article number	H -17 mm	B -47 mm	A cm ²	B mm	B1 / power circuit line 3 x 2,5mm ²			B2 / data line Cat.6		
					B1 mm	B2 mm	Number Ø 10 mm	pay cross section cm ²	Number Ø 8 mm	pay cross section cm ²
S										
UEBS 60-20S	43	154	66	200	76	76	20	1	31	0,64
	63	154	97	200	76	76	29	1	45	0,64
	83	154	128	200	76	76	38	1	60	0,64
	133	154	205	200	76	76	61	1	96	0,64
UEBS 60-30S	43	254	109	300	126	126	33	1	51	0,64
	63	254	160	300	126	126	48	1	75	0,64
	83	254	211	300	126	126	63	1	99	0,64
	133	254	338	300	126	126	101	1	158	0,64
UEBS 60-40S	43	354	152	400	176	176	46	1	71	0,64
	63	354	223	400	176	176	67	1	105	0,64
	83	354	294	400	176	176	88	1	138	0,64
	133	354	471	400	176	176	141	1	221	0,64

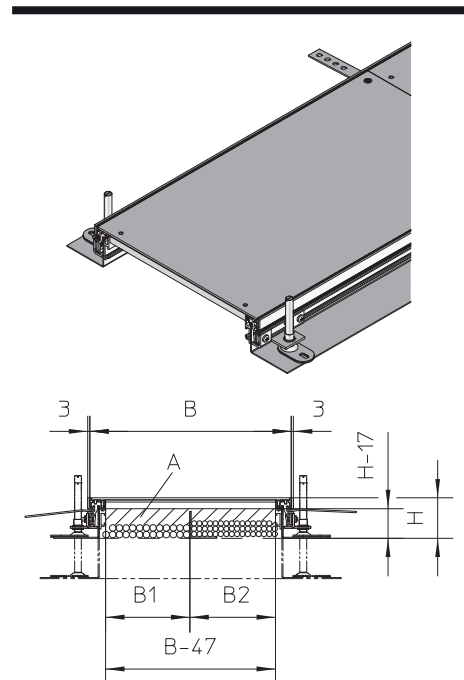

UEBSMSW screed-flush duct with tub

article number	H -17 mm	B -47 mm	A cm ²	B mm	B1 / power circuit line 3 x 2,5mm ²			B2 / data line Cat.6		
					B1 mm	B2 mm	Number Ø 10 mm	pay cross section cm ²	Number Ø 8 mm	pay cross section cm ²
S										
UEBSMSW 60-20S	43	154	66	200	76	76	20	1	31	0,64
	63	154	97	200	76	76	29	1	45	0,64
	83	154	128	200	76	76	38	1	60	0,64
	133	154	205	200	76	76	61	1	96	0,64
UEBSMSW 60-30S	43	254	109	300	126	126	33	1	51	0,64
	63	254	160	300	126	126	48	1	75	0,64
	83	254	211	300	126	126	63	1	99	0,64
	133	254	338	300	126	126	101	1	158	0,64
UEBSMSW 60-40S	43	354	152	400	176	176	46	1	71	0,64
	63	354	223	400	176	176	67	1	105	0,64
	83	354	294	400	176	176	88	1	138	0,64
	133	354	471	400	176	176	141	1	221	0,64

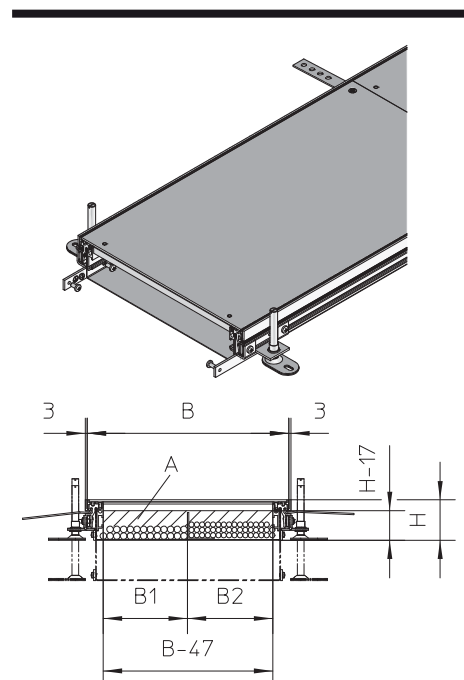

Cable assignment in duct

Technical information

The calculation of the cable volume is the groundwork for the planning process. The cross sections of the selected standard duct types are average values. The calculation is based on a duct filling factor of no more than 60% with a floor box space of max. 8m. Note reduction in the cross-section by the installation depth of device cup and installation unit. For power load see DIN VDE 0100/0298.

Minimum installation cross section for one installation unit

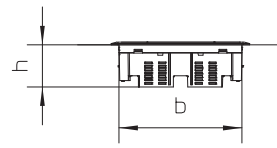

	h mm	b mm	a cm ²
BODO T	100	118	118
UEKD2-R	65	240	156
UEKD2-V	65	184	120
UEKD3-R	65	300	195
UEKD3-V	65	256	166
UEDD V E	70	230	161
UEKDD2 V E	70	155	109
UEKDD1-2 V E	70	130	91

UK screed covered duct, 2 compartments

article number	H mm	B mm	A cm ²	B1 / power circuit line 3 x 2,5mm ²				B2 / data line Cat.6	
				B1 mm	B2 mm	Number Ø 10 mm	pay cross section cm ²	Number Ø 8 mm	pay cross section cm ²
S									
UK 2-28-190S	28	190	53	94	94	16	1	25	0,64
UK 2-28-250S	28	250	70	124	124	21	1	33	0,64
UK 2-28-350S	28	350	98	173	173	29	1	45	0,64
UK 2-38-190S	38	190	72	94	94	21	1	33	0,64
UK 2-38-250S	38	250	95	124	124	28	1	44	0,64
UK 2-38-350S	38	350	133	173	173	39	1	62	0,64
UK 2-48-190S	48	190	91	94	94	27	1	42	0,64
UK 2-48-250S	48	250	120	124	124	36	1	56	0,64
UK 2-48-350S	48	350	168	173	173	50	1	78	0,64

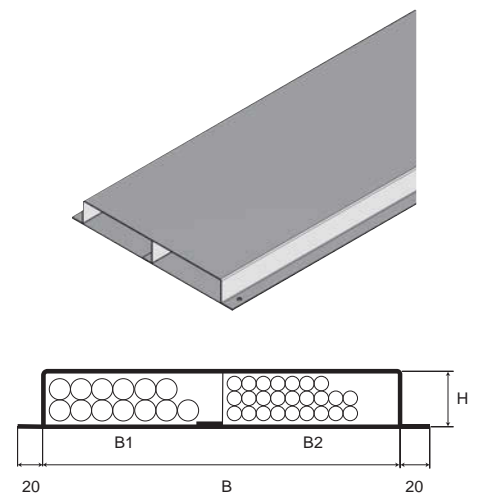

UKL screed covered duct, 3 compartments

article number	H mm	B mm	A cm ²	B1 & B3 / power circuit line 3 x 2,5mm ²				B2 / data line Cat.6		
				B1 mm	B2 mm	B3 mm	Number Ø 10 mm	pay cross section cm ²	Number Ø 8 mm	pay cross section cm ²
S										
UKL 3-28-250S	28	250	70	82	83	82	14	1	22	0,64
UKL 3-28-350S	28	350	98	116	116	116	19	1	30	0,64
UKL 3-38-250S	38	250	95	82	83	82	19	1	30	0,64
UKL 3-38-350S	38	350	133	116	116	116	26	1	41	0,64
UKL 3-48-250S	48	250	120	82	83	82	24	1	37	0,64
UKL 3-48-350S	48	350	168	116	116	116	33	1	52	0,64

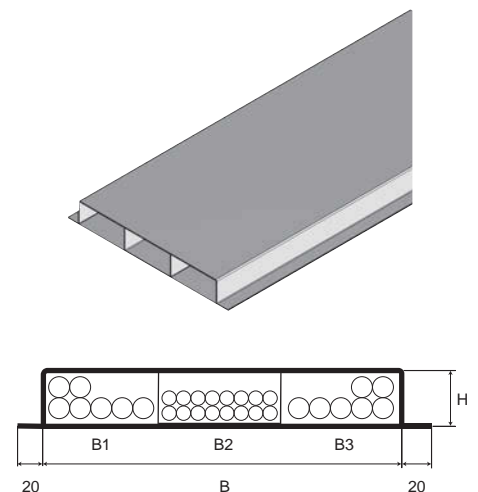

Cable assignment in duct

Technical information

The calculation of the cable volume is the groundwork for the planning process. The cross sections of the selected standard duct types are average values. The calculation is based on a duct filling factor of no more than 60%. Note reduction in the cross-section by the installation depth of device cup and installation unit. For power load see DIN VDE 0100/0298.

Minimum installation cross section for one installation unit

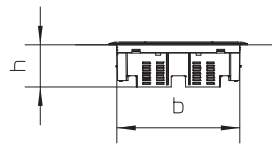

	h mm	b mm	a cm ²
BODO T	100	118	118
UEKD2-R	65	240	156
UEKD2-V	65	184	120
UEKD3-R	65	300	195
UEKD3-V	65	256	166
UEDD V E	70	230	161
UEKDD2 V E	70	155	109
UEKDD1-2 V E	70	130	91

UKR 2 cable duct bottom piece, 2 compartments

article number	H mm	B mm	A cm ²	B1 / power circuit line 3 x 2,5mm ²				B2 / data line Cat.6		
				B1 mm	B2 mm	Number Ø 10 mm	pay cross section cm ²	Number Ø 8 mm	pay cross section cm ²	
S										
UKR 35-30S	35	300	105	149	149	31	1	49	0,64	

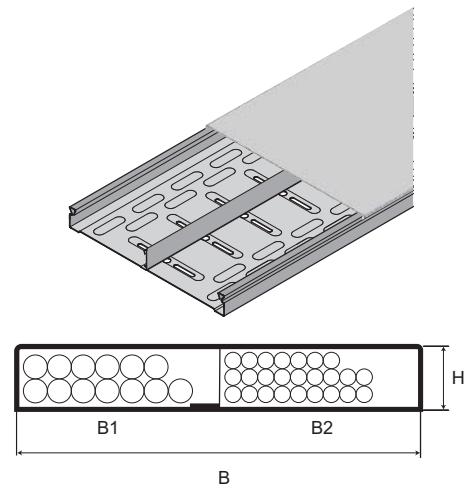

UKR 3 cable duct bottom piece, 3 compartments

article number	H mm	B mm	A cm ²	B1 & B3 / power circuit line 3 x 2,5mm ²					B2 / data line Cat.6		
				B1 mm	B2 mm	B3 mm	Number Ø 10 mm	pay cross section cm ²	Number Ø 8 mm	pay cross section cm ²	
S											
UKR 35-40S	35	400	140	132	132	132	28	1	43	0,64	
UKR 35-50S	35	500	175	165	165	165	35	1	54	0,64	
UKR 60-40S	60	400	240	132	132	132	48	1	74	0,64	
UKR 60-50S	60	500	300	165	165	165	59	1	93	0,64	
UKR 85-40S	85	400	340	132	132	132	67	1	105	0,64	
UKR 85-50S	85	500	425	165	165	165	84	1	131	0,64	
UKR 110-40S	110	400	440	132	132	132	87	1	136	0,64	
UKR 110-50S	110	500	550	165	165	165	109	1	170	0,64	

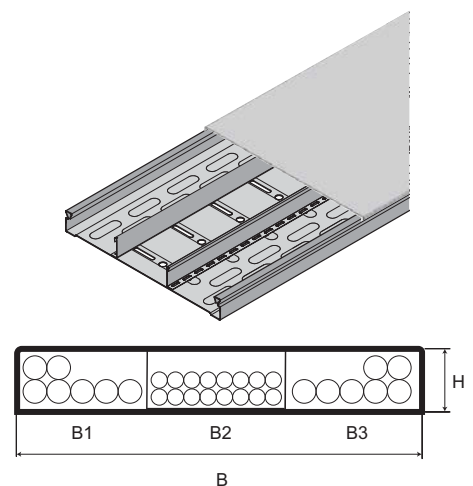

Sound insulation using underfloor duct systems

The sound insulation requirements in buildings are regulated by DIN 4109. The key objective is to keep the noise disturbance on a minimum level. Acoustic decoupling between concrete slab, duct system and screed by means of insulation layers should always be the basic requirement, resulting in the formation of floating screed. Otherwise the excitation of structure borne noise is transmitted directly to the concrete slab, and a reduction of the impact sound pressure level can be only achieved by using soft resilient floor covers.

Measurement method underfloor duct systems

To evaluate the subsonic noise behaviour of screed-covered installation ducts in constructed buildings, measurements according to DIN 52210-2 with standard flanking transmissions according to DIN EN ISO 140-7 were carried out in a test facility.

A standardised force initiated structure-borne noise in the broadcasting room. The testing procedure involved the initiation on screed as well as directly on the duct, respectively on the installation unit.

The reception levels were determined using a real-time analyser and a microphone as measuring instruments. The standard subsonic noise $L'_{n,w}$ is calculated as a parameter of the construction part to be evaluated while taking into account the volume and the reverberation period.

The reduction of subsonic noise ΔL_w equals the difference between the standard subsonic noise of a floor with and without floor cover. However, the reduction of subsonic noise must be at least effective enough to ensure that the required standard subsonic noise in office buildings is not exceeded. The required standard subsonic noise values in office buildings are specified as follows:

Normal requirements standardised impact sound pressure level

$$L'_{n,w} \leq 53 \text{ db (DIN 4109 table 3)}$$

Raised requirements (suggestions) impact sound pressure level

$$L'_{n,w} \leq 46 \text{ db (DIN 4109 supplement 2 table 3)}$$

Receiving room



Broadcasting room

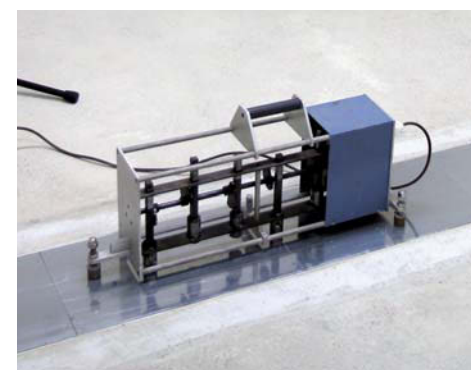

For the accuracy of the measuring results



IBAS Berlin GmbH
Scharnweberstr. 104
12587 Berlin
Tel.: 030/6486032
Fax: 030/64849207

IBAS

Ingenieurgesellschaft für Bauphysik, Akustik und Schwingungstechnik mbH
Meßstelle nach § 26 BImSchG



Impact noise behaviour | Screed-covered underfloor duct system

Technical information

Test

Duct UKL, hollow space floor box UBDHB350 V and with plastic installation unit UEKD3 V, quadrangular

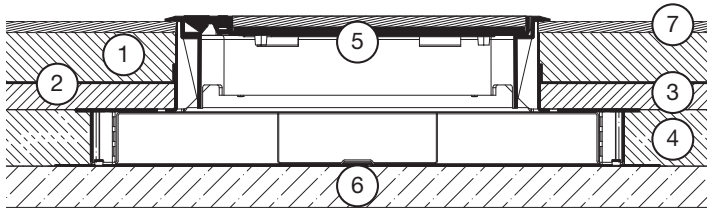

Test setup	ΔL_w (dB)	$L'_{n,w}$ (dB)
Duct system installed in floating screed, stimulation on screed	29	52
Duct system installed in floating screed, stimulation on screed with textile floor cover	40	41
Duct system installed in floating screed, stimulation on installation unit with textile floor cover	46	35

Results according to test report 13-840 from March 2014

Duct UKL, hollow space floor box UBDHB350 V and with high-grade steel installation unit UEKD V E, mounted quadrangular on levelling unit UNE

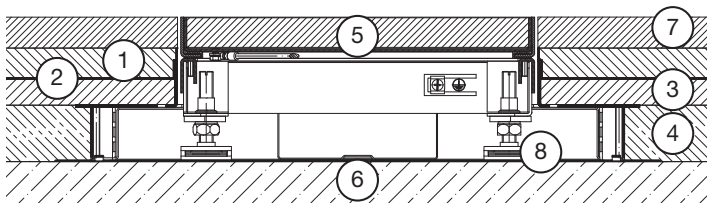

Test setup	ΔL_w (dB)	$L'_{n,w}$ (dB)
Duct system installed in floating screed, stimulation on high-grade steel installation unit with parquet floor cover	28	53
Duct system installed in floating screed, stimulation on high-grade steel installation unit with parquet floor cover, decoupling over the rubber sleeve	31	50

Results according to test report 13-840 from March 2014

Setup:

1. 50 mm cement screed
2. 1 mm foil
3. 20 mm impact sound insulation plate
4. 40 mm heat insulation plate
5. installation unit
6. 160 mm concrete slab
7. floor cover (carpet 8,0 mm, parquet 12 mm)
8. rubber sleeve UGM

$L'_{n,w} = 81$ dB stimulation on concrete slab

$L'_{n,w} = 50$ dB stimulation on screed, without installations

Test results

The test results with all proper applications show that the screed-covered underfloor system meets the standard noise protection requirement of 53 dB for floors in office buildings. The installation of the underfloor systems into the floating screed of a floor is therefore completely unproblematic as to the subsonic noise behaviour.

Whether the noise stimulation occurs on screed or directly on the installation unit is irrelevant for the laying of carpet floor covers or parquet. An additional decoupling of the levelling systems from the concrete slab by means of a rubber sleeve results in an impact noise improvement by 3 dB as opposed to the direct mounting of the levelling system to the concrete slab. The advantage of the new hollow space floor box is its complete mechanical decoupling from the duct system and becomes especially obvious with the use of parquet, stone, mastic asphalt surfaces or exposed concrete.

Broadcasting room with parquet floor covers

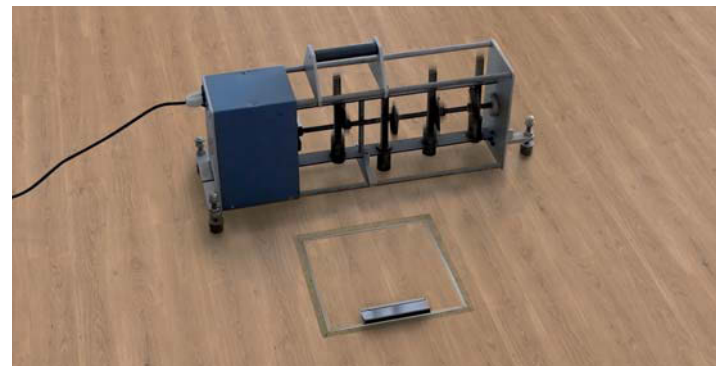

Broadcasting room with carpet floor covers

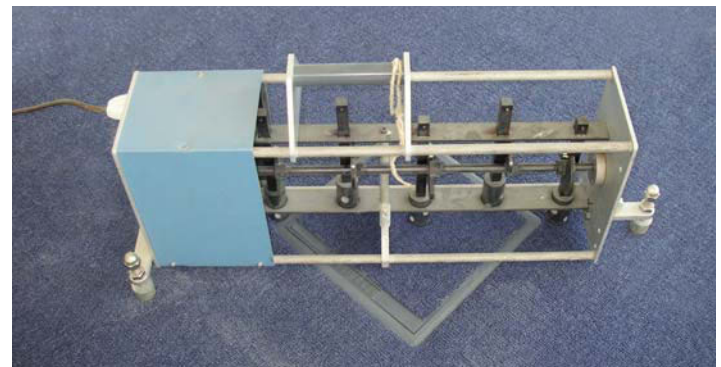

Impact noise behaviour | Screed-flush underfloor duct system

Technical information

Test

Duct UEBS and a outboard leveling

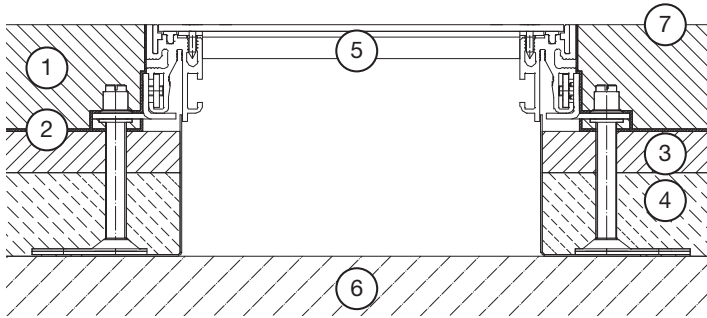

Test setup	ΔL_w (dB)	$L_{n,w}^*$ (dB)
Duct system installed in floating screed, stimulation on screed and duct	28	53
Duct system installed in floating screed, stimulation on screed and duct with linoleum	33	48
Duct system installed in floating screed, stimulation on screed and duct with textile floor cover	40	41

Results according to test report 13-840 from March 2014

Duct UEBS and a internal leveling

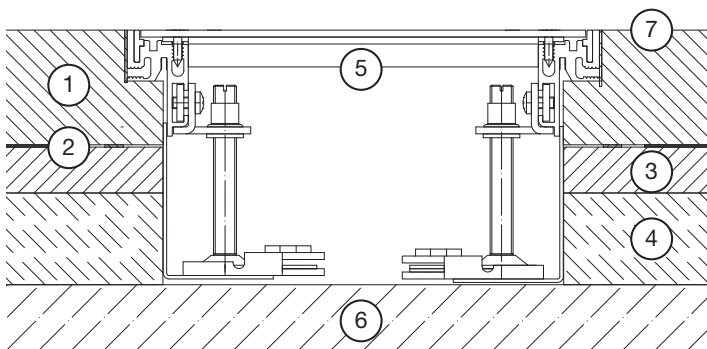

Test setup	ΔL_w (dB)	$L_{n,w}^*$ (dB)
Duct system installed in floating screed, stimulation on screed and duct without decoupling	28	53
Duct system installed in floating screed, stimulation on screed and duct, decoupling over the rubber sleeve	29	52
Duct system installed in floating screed, stimulation on screed and duct, decoupling suspended without leveling	30	51

Results according to test report 13-840 from March 2014

Setup:

- 50 mm cement screed
- 1 mm foil
- 20 mm impact sound insulation plate
- 40 mm heat insulation plate
- screed-flush duct UEBS
- 160 mm concrete slab
- floor cover (carpet 8,0 mm, linoleum 2,8 mm)

$L_{n,w}^* = 81$ dB stimulation on concrete slab

$L_{n,w}^* = 50$ dB stimulation on screed, without installations

Test results

The test results with all proper applications show that the screed-flush underfloor system meets the standard noise protection requirement of 53 dB for floors in office buildings. The installation of the underfloor systems into the floating screed of a floor is therefore completely unproblematic as to the subsonic noise behaviour.

When laying carpet or linoleum floor covers, it is irrelevant in this context, whether the subsonic noise initiation occurs on screed or directly on the duct. Even in case of an initiation without floor cover the standard subsonic noise requirements are met.

A decoupling of the duct system with inside levelling through a rubber cuff renders a subsonic noise reduction of up to 1 dB. A complete decoupling by means of a subsequent removal of the levelling supports after the hardening of screed results in a subsonic noise reduction of up to 2 dB.

Broadcasting room with carpet floor covers

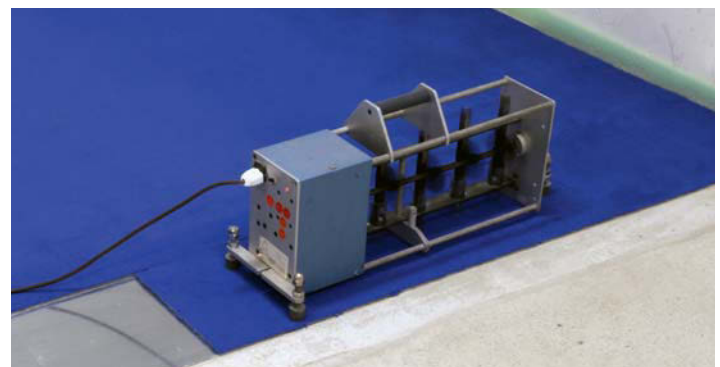

Broadcasting room with linoleum floor covers

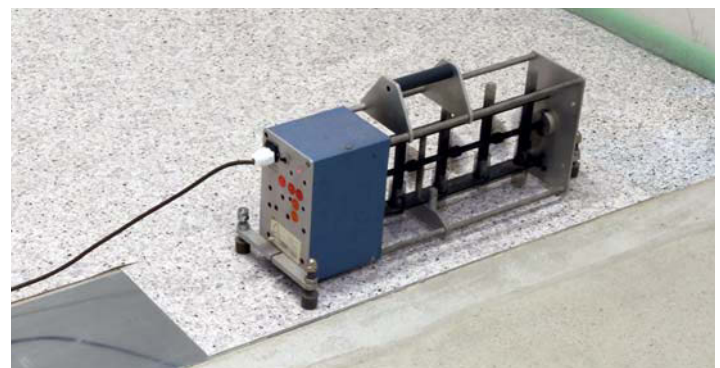

E

Casing depth device cup including installation device

Technical information

General Requirements

For underfloor trunking systems, the height of the floor construction primarily determines the tolerance for the installation of the installation unit, device cup and installation equipment.

In order to meet the basic requirements according to protection type IP 20 based on DIN EN 50085, the cover or the cartridge must be lockable in working condition. Thereby the required minimum system installation height is derived for the use of angled or straight connectors of data, respectively power technology.

Technical specifications

Minimum installation depths of system components

The minimum installation depths we calculated refer to the minimum size of the common market connectors for power engineering shown in the illustrations.

The use of CEE sockets with angled connectors requires an especially high floor structure of at least 185 mm. If straight connectors are used the unit can not be locked in due form in used condition.

angled connector straight connector adapter CEE socket

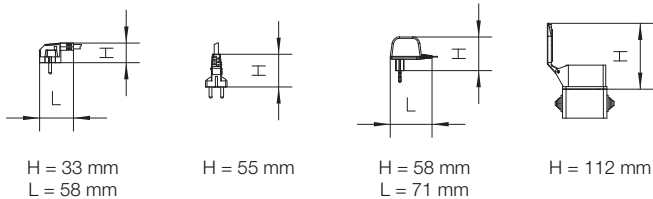

The use of locked-in leads made of plastic material and stainless steel in the corresponding installation units allows to lower the installed devices stepwise in the device cups or device carriers by up to 30 mm. This only applies if the necessary tolerance below the installation unit is provided and is not blocked by power cables or cables for data technology.

The previously mentioned cable duct height should be especially adhered to when screed covered duct systems are installed. In that case the tolerance is reduced by 28 to 48mm height, depending on the applied duct height.

minimum installation height 74 mm maximum installation height 104 mm

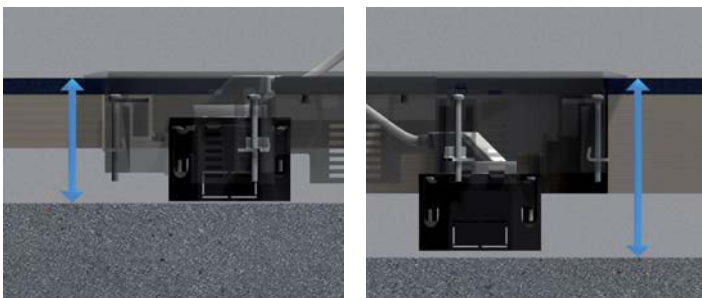

CEE socket with angled connector CEE socket with straight connector



The floor power sockets BODO require the following minimum installation heights (Hmin).

BODO N | Hmin = 87 mm

BODO T | Hmin = 102 mm

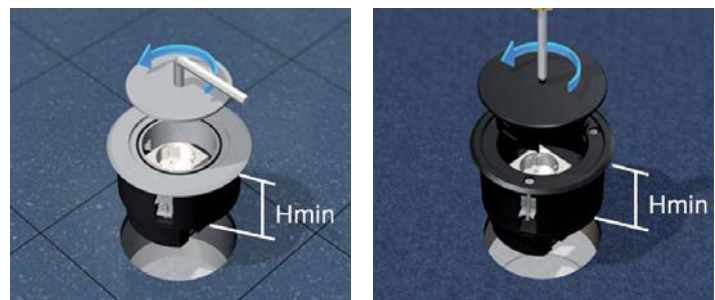

In order to guarantee a safe and non-slip surface, angled as well as straight connectors can be used.

Casing depth device cup including installation device

Technical information

Plastic installation units*

Please note that with plastic units the depth of the floor cover in the cover is based on carpeting of up to 8 mm. The shown minimum installation depths are based on quadrangular and round plastic material units.

A head space > 65 mm between raw ceiling and floor cover surface is needed for coupler plugs in device insert.

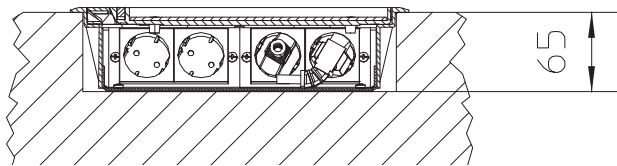

A head space > 87 mm (UG45 > 80 mm) between raw ceiling and floor cover surface is needed for angle plug in electrical socket inside device cup.

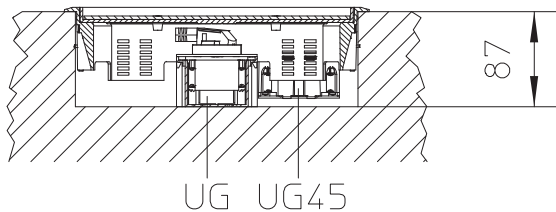

Provided the smallest possible bending radius 4D of installation cables of up to Ø 10 mm is to be complied to the resulting minimal installation depth of the device carrier UGETD is > 120 mm from the upper edge of the floor cover to the raw floor. The same applies when a flexible straight connector in a device cup socket is used.

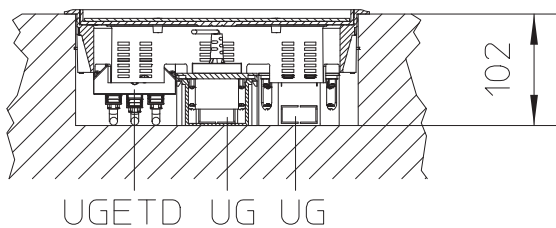

A head space > 131 mm between raw ceiling and floor cover surface is needed for inflexible straight line plug resp. charging set in electrical socket inside device cup in connection with registering extension for device cup installation.

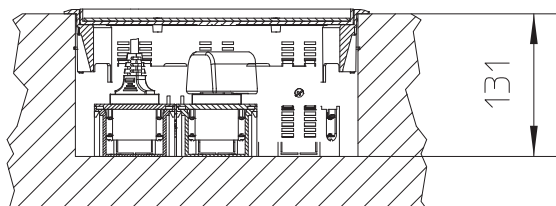

Stainless steel installation units, square*

Please note that with stainless steel units, the depth of the floor cover applies to floor covers of up to 12 mm. The following minimum installation depths apply to quadrangular stainless steel units. A fitting into round stainless steel installation units may require higher installation depths.

If coupler plugs are used in the device insert, a tolerance of > 85 mm is needed from the upper edge of the floor cover to the slab ceiling.

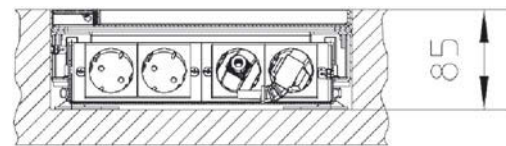

If an angled connector of up to 35mm height is used in a socket in a device cup UG, a tolerance of > 95 mm (UG45 > 88 mm) is needed from the upper edge of the floor cover to the slab ceiling.

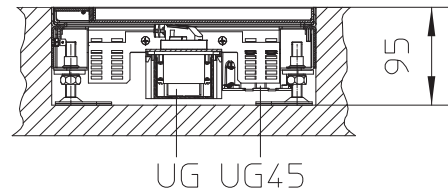

Provided the smallest possible bending radius 4D of installation cables of up to Ø 10 mm is to be complied to, the resulting minimal installation depth of the device carrier UGETD is > 120 mm from the upper edge of the floor cover to the raw floor. The same applies when a flexible straight connector in a device cup socket is used.

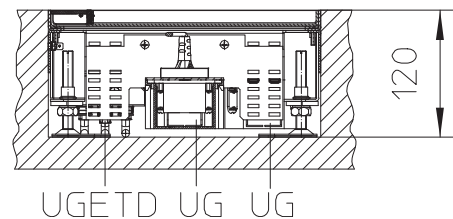

If a rigid straight connector, respectively a charging device is used in a socket in the device cup, a tolerance of > 140 mm is needed from the upper edge of the floor cover to the slab ceiling.

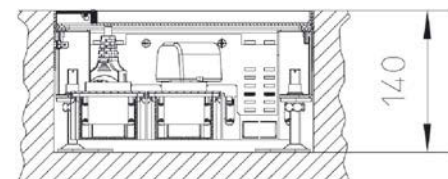

*Please observe the above specified dimensions for floor construction!

Types of protection and floor maintenance of installation units

Technical information

General Requirements

The testing of the type of protection for underfloor trunking systems and cable ducting systems is regulated by EN 60529, and the type of testing of floor maintenance by DIN EN 50085. In order to determine the optimum type of protection, the installation unit is tested in both, used and unused condition. The respective conditions are declared separately. All cable systems and installation units must fulfil at least protection type IP 20 in both conditions, used and unused. Additionally to the declaration of the protection type for wet maintenance it must be ensured that in working condition the cable exits are placed at least 10 mm above the floor surface.

Technical exemplifications

Labelling

All PUK installation units are labelled according to DIN EN as follows:



Dry maintenance

The process of cleaning and / or maintenance of the floor, during which dry or low-moisture methods covers are used that do not cause a pool formation or soaking of the floor.



Wet maintenance

The process of cleaning and / or maintenance of the floor during which wet cleaning or maintenance items are used, that may cause a short-term pool formation or soaking of the floor covers.

Data sheets

The data sheets obtain the protection type for all PUK system installation units in unused / used condition as well as the application area of floor maintenance based on classified tests according to DIN EN 50085.

The specifications differentiate between rooms with dry, moist and wet maintenance floors.

The application areas of floor maintenance are in accordance with the definitions of the commercial cleaning trade, and the specification of protection type is based on classification.

Application recommendations

According to DIN EN 50085 the underfloor system is not suitable for outdoor use!

Wet maintenance

Based on the IP-protection levels listed in the data sheets, the stainless steel installation units guarantee protection against contact and against water according to the requirements of DIN EN 50085. A passing over with simultaneous cleaning of the installation units is not a part of this norm specification. The VDE views the examination of load capacity and of protection type separately. A combination of both is not intended.

Consequentially, a double pressure caused by a heavy, unilateral weight and by power water is not provided in the regulations. Overly high water- and loading pressure can result in dust particles and cleaning liquids entering the inside of the installation unit. Above mentioned floor maintenance may cause damage and impairment of the rubber seals. In order to ensure the safety level, we recommend that all sealed components of the installation units are cleaned and maintained on a regular base.

Dry maintenance

Based on the IP protection levels stated in the data sheets, the plastic material installation units guarantee protection against contact and against water according to the regulations by DIN EN 50085. The DIN EN 50085 requires a minimum standard of IP 20.

Plastic installation units are therefore suitable for carpet floors and offer no protection against water ingress.

Improper floor maintenance may cause damage to the installation unit and to the electric installation. In order to maintain visual attractiveness and functionality, regular cleaning is recommended.

If the stated instructions are adhered to, it can be ensured that the underfloor electric installation is protected from harmful effects during standard use.

Types of protection and floor maintenance of installation units

Technical information

Type of protection according to classification

The types of casting protection are specified in the regulations IEC 60529, respectively DIN EN 60529, both containing a classification according to different types of protection. The below illustration shows an overview of the protection types.

















Code Letter: International Protection (IP)		First Index Number: Protection against solid foreign particles	Second Index Number: Protection against water
Scope of protection		Scope of protection	
0		no protection against contact, no protection against solid foreign particles	0  no protection against water
1		protection against large area contact with the hand, protection against foreign particles of $\varnothing \geq 50$ mm	1  protection against dripping water, vertically falling water drops
2		protection against contact with fingers, protection against foreign particles of $\varnothing \geq 12,5$ mm	2  protection against dripping water from any angle up to 15° from a vertical position
3		protection against contact with tools, wires, etc. of $\varnothing \geq 2,5$ mm, protection against foreign particles of $\varnothing \geq 2,5$ mm	3  protection against spraying water from any angle up to 60° from a vertical position
4		protection against contact with tools, wires, etc. of $\varnothing \geq 1$ mm, protection against foreign particles of $\varnothing \geq 1$ mm	4  protection against splashing water from any direction
5		protection against touch, protection against dust accumulation on the inside	5  protection against water jet from any angle
6		complete protection against touch, protection against ingress of dust	6  protection against heavy water jet from any angle
			7  protection against water intrusion with a temporary submerge
			8  protection against water intrusion with lasting submerge

Illustration based on DIN EN 60529, IEC 60529
visual material of www.solamagic.com

Types of cleaning according to the commercial cleaning definitions*

Damp wiping

Definition: Dust-mopping on a stage work level with damp or prepared cleaning textiles for the removal of loose surface dust and to a lesser degree also for the removal of persistent surface dirt.

Goal / Result: The surface is clean of persistent dirt and of surface dust.

Remarks / Notes: Voraussetzungen zur Anwendung der Feuchtwischmethode sind glatte Bodenbeläge.

Wet wiping

Definition: Manual wet mopping with cleaning textiles for the removal of adhesive dirt.

Goal / Result: The surface is clear of dust, persistent dirt, and adhesive dirt.

Wet wiping, single stage

Definition: The cover is cleaned in one work step with more or less strongly drained cleaning textiles.

The liquid remaining after this work step is left to dry.

Wet wiping, two-stage





Definition: The two-stage method represents the conventional wet wiping method. In the first work step, a considerable amount of cleaning liquid is applied to the floor cover using a cleaning textile, in order to soak, respectively dissolve, persistent and water-bound dirt.

In the second work step, the remaining soiled liquids are absorbed and wiped off with the cleaning textile.

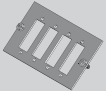
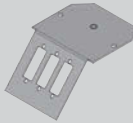

*Excerpt from the cleaning methods based on the definitions of commercial cleaning.







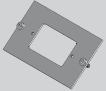
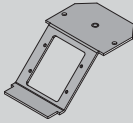

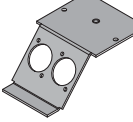
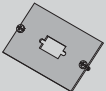

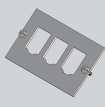
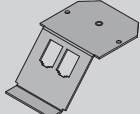

Light wave technology

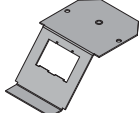
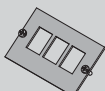
mounting boards UDEP for device carrier UGETD	device carrier UGET 113 for device mounting cup UG	manufacturer	mounting
			SC-Duplex
UDEP-SCD 4	UGET-3-SCD 113		
			SC-Simplex LC-Duplex
UDEP-SCS 4	UGET-3-SCS 113		
			LC-Duplex Multimode
	UGET-2-LCDM 113		

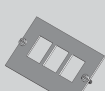
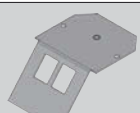
Audio- / video technology

mounting boards UDEP for device carrier UGETD	device carrier UGET 113 for device mounting cup UG	manufacturer	mounting
		Kindermann Kindermann	Konnect 50 alu / 50 steel connection face place 25 x 50 mm (UDEP-KM 1) Konnect 50 alu / 50 steel connection face place 50 x 50 mm (UGET-2-KM 113)
UDEP-KM 1	UGET-2-KM 113		
		Neutrik	D Serie, DL Serie, DLX Serie
UDEP-XLR 2	UGET-2-XLR 113		
			D-Sub 9
UDEP-DSUB9 1			

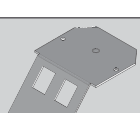



Data technology

mounting boards UDEP for device carrier UGETD	device carrier UGET 113 for device mounting cup UG	manufacturer	mounting
 UDEP-BTR 3	 UGET-2-BTR 113	BTR BTR BTR BTR BTR Dätwyler LEONI Kerpen	E-DAT module Cat.6 8(8) E-DAT module coupler 8(8) Cat.6 8(8) 90° Cat.6 UAE module Cat.5e 8(8) or Cat.6 8(8) OpDAT module LC or ST KOAX module F/F or F/IEC-plug or socket Unilan® RJ45-Module MS 1/8 Cat.6/EA shielded VariOKeystone® Socket module RJ45 or 4K7 or 4K6
 UDEP-COR 3	 UGET-2-COR 113	Corning Corning Corning Corning	FutureCom™ S10™e Module Kat. 6 _A , LANscape® FutureCom™ S500 Module Kat. 6 _A , LANscape® FutureCom™ S250 Module Kat. 6, LANscape® FutureCom™ S100e Module Kat. 5e, LANscape®
 UDEP-HAR PL3		Harting Harting	Ha-VIS PreLink RJ45 socket Keystone module Cat6 Ha-VIS RJ45 socket Keystone set AWG22/23 Cat6
 UDEP-AMP 3	 UGET-2-AMP 113	TE Connectivity Corning Siemon	AMP FutureCom™ S1200 Module Kat.7 _A , LANscape® TERA® 4-Pair Outlet
 UDEP-AMP SL3	 UGET-2-AMPSL 113	TE Connectivity TE Connectivity TE Connectivity	AMP-TWIST 7AS SL Jack AMP-TWIST 6 _A S SL Jack AMP-TWIST 6S SL Jack
 UDEP-GG45 3	 UGET-2-GG45 113	3M Deutschland GmbH 3M Deutschland GmbH 3M Deutschland GmbH Brand-Rex Brand-Rex Nexans Nexans	3M Volition RJ45 connecting module CAT6A PL 180 3M Volition K6 RJ45 connecting module STP, single shielded 3M Volition K6 RJ45 connecting module STP, without shielding cover 10GPlus CAT6 _A shielded module, tool-free AC6JAKS000 Cat6Plus shielded module, tool-free C6CJAKS000 LANmark EVO module up to Cat.6A with Keystone clip blue LANmark GG45 Module Cat.7/7 _A with metal clip
 UDEP-KR 2	 UGET-2-KR 113	TE Connectivity TE Connectivity Brand-Rex Brand-Rex CobiNet CobiNet CobiNet CobiNet CobiNet Corning Corning Corning Dätwyler Dätwyler DIGITUS ECOLAN EFB EFB eku Kabel & Systeme eku Kabel & Systeme LEONI Kerpen LEONI Kerpen R&M R&M R&M Rutenbeck Rutenbeck Telegärtner Telegärtner ZVK ZVK	KRONE RJ45 STP KM8® Modular Jack Cat.6 _A KRONE RJ45 STP KM8® Modular Jack Cat.6 Cat6Plus Module C6CJAKS000CR "old version" 10GPlus Module AC6JAKS000CR "old version" CobiDat KS ICS 250 / 500 CobiDat KS IPS 250 / 500 CobiDat KS TPS 500 RJ45-Module TopKey FutureCom™ xs500 Module Kat. 6 _A , Keystone FutureCom™ S500 Module Kat. 6 _A , Keystone FutureCom™ S10™e Module Kat. 6 _A , Keystone Unilan MS-K 1/8 Socket module Unilan KS-T 1/8 Socket module Keystone Module ELN336102 Cat.6a RJ45 Keystone module E-20070 Cat.6a RJ45 Keystone module E-20072 Cat.6 RJ45 Keystone module E-Stone Module Cat.6 _A , t66851000 E-Stone Pro Module Cat.6 _A , t66850990 MegaLine® Connect45 BM Keystone Kat. 6 _A MegaLine® Connect45 BM Keystone LEO Kat. 6 _A Connecting module Cat.6A ISO, 1xRJ45/s, Snap-in Connecting module Kat.6, Real 10, 1xRJ45/s, Snap-in Connecting module Kat.5, 1xRJ45/s, Snap-in All-purpose module UM-Cat.6A iso A, Keystone edition All-purpose module UM-real Cat.6 U A, unshielded, Keystone edition AMJ-Module K Cat.6 _A AMJ-S-Module Cat.6 _A EasyLan® preLink® RJ45 Keystone module (CKPAS010 / CKPAS020) EasyLan® fixLink® RJ45 Keystone module (CKFAK000 / CKFAKFLO)
 UDEP-RM 2	 UGET-1-RM 113	R&M R&M R&M R&M	Connecting module Cat.6A ISO, 1xRJ45/s (module fixture required) Connecting module, Kat.6, Real 10, 1xRJ45/s (module fixture required) Connecting module, Kat.5, 1xRJ45/s (module fixture required) Module fixture RJ45 / E-2000™-Compact / SC-RJ / all-purpose adapter



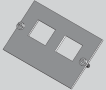

E

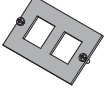
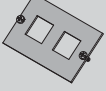
Data technology

mounting boards UDEP for device carrier UGETD	device carrier UGET 113 for device mounting cup UG	manufacturer	mounting
		R&M R&M R&M R&M R&M	Connecting module Cat.6A ISO, 1xRJ45/s, Snap-in Connecting module Kat.6, Real 10, 1xRJ45/s, Snap-In Connecting module Kat.5, 1xRJ45/s, Snap-in Connecting module Kat.6, 1xRJ45/u, Snap-in Connecting module Kat.5, 1xRJ45/u, Snap-in
		Brand-Rex Brand-Rex CobiNet CobiNet CobiNet Corning Corning Corning Dätwyler Dätwyler DIGITUS ECOLAN EFB EFB eku Kabel & Systeme eku Kabel & Systeme LEONI Kerpen LEONI Kerpen R&M R&M R&M Rutenbeck Rutenbeck Telegärtner Telegärtner ZVK ZVK	Cat6Plus Module C6CJAKS000CR "old version" 10GPlus Module AC6JAKS000CR "old version" CobiDat KS ICS 250 / 500 CobiDat KS IPS 250 / 500 CobiDat KS TPS 500 RJ45-Module TopKey FutureCom™ xs500 Module Kat. 6 _A , Keystone FutureCom™ S500 Module Kat. 6 _A , Keystone FutureCom™ S10™e Module Kat. 6 _A , Keystone Unilan MS-K 1/8 Socket module Unilan KS-T 1/8 Socket module Keystone Module ELN336102 Cat.6a RJ45 Keystone module E-20070 Cat.6a RJ45 Keystone module E-20072 Cat.6 RJ45 Keystone module E-Stone Module Cat.6 _A , t66851000 E-Stone Pro Module Cat.6 _A , t66850990 MegaLine® Connect45 BM Keystone Kat. 6 _A MegaLine® Connect45 BM Keystone LEO Kat. 6 _A Connecting module Cat.6A ISO, 1xRJ45/s, Snap-in Connecting module Kat.6, Real 10, 1xRJ45/s, Snap-in Connecting module Kat.5, 1xRJ45/s, Snap-in All-purpose module UM-Cat.6A iso A, Keystone edition All-purpose module UM-real Cat.6 U A, unshielded, Keystone edition AMJ-Module K Cat.6 _A AMJ-S-Module Cat.6 _A EasyLan® preLink® RJ45 Keystone module (CKPAS010 / CKPAS020) EasyLan® fixLink® RJ45 Keystone module (CKFAK000 / CKFAKFLO)
		LEONI Kerpen LEONI Kerpen LEONI Kerpen LEONI Kerpen LEONI Kerpen	ELine 1200® EC7 socket ELine 500® plus socket ELine 500™ RJ45 S socket ELine 250® RJ45 S socket ELine 250® RJ45 U socket
		Systemax Systemax	Systemax: MPS 100E cat.5, MPS S200E (required: Systemax installation frame type: M30MC) Systemax: MGS 300, MGS 400, MGS 500X10D, MGS 600X10D (required: Systemax installation frame type: M30MC)
		LexCom LexCom	LexCom: LexCom® 125 (required: LexCom installation frame) LexCom: LexCom® 250 (required: LexCom installation frame)

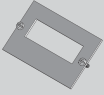
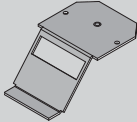
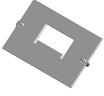
Plug-in systems

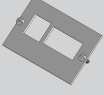
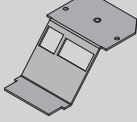
mounting boards UDEP for device carrier UGETD	device carrier UGET 113 for device mounting cup UG	manufacturer	mounting
 UDEP-5PK 1	 UGET-1-5PK 113	WAGO Wieland	Snap-in socket/plug 5-pole Snap-in socket/plug 5-pole
 UDEP-5PCOM 1	 UGET-1-5PCOM 113	WAGO	5-pole X-COM
 UDEP-3PK 2	 UGET-2-3PK 113	Wieland	1x 2-pole Bus, 1x 3-pole 250V

Installation units, pre-snap-in

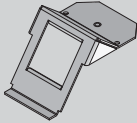
mounting boards UDEP for device carrier UGETD	device carrier UGET 113 for device mounting cup UG	manufacturer	mounting
	 UGET-1-UST45 113	PEHA Legrand Simon	2x 22,5 x 45 mm or 1x 45 x 45 mm 2x 22,5 x 45 mm or 1x 45 x 45 mm 2x 22,5 x 45 mm or 1x 45 x 45 mm



